



Code-Point[®] with polygons

User guide and technical specification

Code-Point with polygons

User guide

Contents

Section	Page no
Preface	3
Contact details	3
Use of the product.....	3
Purpose and disclaimer	3
Copyright in this guide	4
Data copyright and other intellectual property rights	4
Trademarks	4
Back-up provision of the product	4
Using this guide.....	4
Chapter 1 Introduction	5
Using this user guide	5
Applications of Code-Point with polygons.....	5
Dataset contents	5
Attribute accuracy	5
Chapter 2 Overview of Code-Point with polygons	6
Data overview	6
Basic principles	6
Using Code-Point with polygons.....	6
Chapter 3 Code-Point with polygons explained.....	8
Chapter 4 Creating single-space postcodes	10
Centroids and polygons	10
Outward and inward bound representation	10
Single-space postcodes.....	10
CSV single-space postcodes using Microsoft Excel and Access	10
MID/MIF and TAB single-space postcodes using MapInfo.....	10
Shapefile single-space postcodes using ESRI ArcGIS	12
Chapter 5 Data measures.....	16
Annexe A Case studies	17
Sharing data across the NHS® to improve patient services	17
Annexe B Metadata.....	18
Annexe C Product and service performance report form	19

v2.11 – 11/2010

D05300_12

Preface

This user guide (hereafter referred to as the guide) is designed to provide an overview of Code-Point® with polygons (hereafter referred to as the product) and it gives guidelines and advice on how a customer might derive the maximum benefit from the product. It assumes a general knowledge of geographic information. If you find an error or omission in this guide, or otherwise wish to make a comment or suggestion as to how we can improve the guide, please contact us at the address shown below under contact details or complete the product and service performance report form at [annexe C](#) and return it to us.

Contact details

Our Customer Service Centre will be pleased to deal with your enquiries:

Customer Service Centre
Ordnance Survey
Adanac Drive
SOUTHAMPTON
SO16 0AS

General enquiries (calls charged at local rate): +44 (0)8456 05 05 05

Dedicated Welsh Language HelpLine: 08456 05 05 04

Textphone (deaf and hard of hearing users only please): +44 (0)23 8005 6146

Email: customerservices@ordnancesurvey.co.uk

or visit the Ordnance Survey website at: www.ordnancesurvey.co.uk

This document has been screened in accordance with the requirements set out in Ordnance Survey's Equality scheme. If you have difficulty reading this information in its current format and would like to find out how to access it in a different format (Braille, large print, computer disk or in another language), please contact us on: +44 (0)8456 05 05 05.

Use of the product

The terms and conditions upon which the product, including this guide, is made available to you and your organisation are contained in the customer contract made between you and Ordnance Survey. If there is an inconsistency between the terms of your customer contract and this guide, then the terms of your customer contract prevail. If you or your organisation has not signed a valid current customer contract then you are not entitled to use the product.

Purpose and disclaimer

This guide is provided for guidance only and does not constitute any warranty, representation, undertaking, commitment or obligation (express or implied) about the product or its suitability for any particular or intended purpose. Any warranties, representations, undertakings, commitments and obligations given by Ordnance Survey about the product and/or its suitability for any particular or intended purpose are set out in your customer contract. It is your responsibility to ensure that this product is suitable for your intended purpose.

Ordnance Survey does not accept any liability (whether for breach of contract, negligence or otherwise) for any loss or liability you or any third party may suffer in relying on this guide and any guidance, suggestion, advice or explanation provided in it. Any liability that Ordnance Survey has to you in relation to the product, its supply, use, accuracy, data supplied, functionality or any other liability arising out of or in connection with the product is limited as set out in your customer contract.

We may change the information in this guide at any time without notice.

We do not accept responsibility for the content of any third party websites referenced or accessed in or through this guide, any contractual documentation, and/or the Ordnance Survey website.

Copyright in this guide

This guide (including for the avoidance of doubt any mapping images reproduced herein), is © Crown copyright 2010. All rights reserved.

Any part of this guide may be copied for use internally in your organisation or business so that you can use the product for the purpose for which it is licensed to your organisation or business (but not otherwise).

No part of this guide may be reproduced or transmitted in any form or by any means (including electronically) for commercial exploitation without the prior written consent of Ordnance Survey.

No part of this guide may be copied or incorporated in products, services or publications that you generate for onward sale, or as free promotional or support materials, without the prior written consent of Ordnance Survey.

Data copyright and other intellectual property rights

The Crown (or, where applicable, Ordnance Survey's suppliers) owns the intellectual property rights in Ordnance Survey digital map data.

Full details of the terms and conditions under which Ordnance Survey digital map data may be processed and/or manipulated or copied by a customer – whether or not for use on PCs or workstations or for making hard copies – are available from the Customer Service Centre, please see [contact details](#). You should check the terms and conditions with us before using the data. It is also the responsibility of the holder of the digital map data to ensure that any plotted or printed output contains the required copyright and database acknowledgements in a conspicuous position.

The product makes use of Royal Mail® PAF® (Postcode Address File) and Geoplan®.

Trademarks

Ordnance Survey, the OS Symbol, ADDRESS-POINT, Code Point and Gridlink are registered trademarks and Boundary-Line is a trademark of Ordnance Survey, the national mapping agency of Great Britain.

Acrobat Reader and Adobe are registered trademarks of Adobe Systems Incorporated.

Autodesk is a registered trademark of Autodesk Incorporated.

ESRI and ArcGIS are registered trademarks of Environmental Systems Research Institute, Inc.

Geoplan is a registered trademark of Yellow Marketing Information Ltd.

MapInfo is a registered trademark of MapInfo Corporation.

Microsoft and Excel are registered trademarks of Microsoft Corporation.

PAF, Post Office, Postzon and Royal Mail are registered trademarks of Royal Mail Group plc.

Back-up provision of the product

You are advised to copy the supplied data to a backup medium.

Using this guide

The documentation is supplied in portable document format (PDF) only. Free Adobe® Acrobat Reader® software, which displays the guide, incorporates search and zoom facilities and allows you to navigate within. Hyperlinks are used to navigate between associated parts of the guide and to relevant Internet resources by clicking on the blue hyperlinks and the table of contents.

If you are unfamiliar with any words or terms used and require clarification please refer to the [Glossary](#) at the end of the document.

Chapter 1 Introduction

Using this user guide

This guide concentrates on the polygons that make up the Code-Point with polygons product. For information regarding the associated Code-Point data, reference should be made to the [Code-Point user guide and technical specification](#).

Applications of Code-Point with polygons

Code-Point with polygons can be used to display and analyse any data collected at the [postcode](#) level. This has led to the product being widely used in a variety of applications including:

- site location;
- market analysis and profiling;
- health and epidemiology;
- resource allocation;
- socio-economic profiling; and
- sales targeting.

Dataset contents

The polygon dataset provides:

- A set of 120 postal-area-based files that, when viewed using appropriate geographical information system (GIS) software, provide a set of boundaries for the postcode units in Great Britain. Where possible, these boundaries are nested within Geoplan[®] postcode boundaries.
- Corresponding 120 postal-area-based files containing:
 - [vertical streets](#); and
 - 120 containing [PO boxes](#) and [Discards](#).
- Further associated data, metadata and information files are supplied on the accompanying Code-Point product CD.

The data is supplied in two parts: firstly, the CD containing Code-Point data information and, secondly, the CD(s) containing the polygons. Both the Code-Point and the Code-Point with polygons CDs have to be loaded to ensure all the data is imported.

Attribute accuracy

All polygons are attributed. Nothing is done to change the accuracy inherited from the PAF source data.

Chapter 2 Overview of Code-Point with polygons

Data overview

Basic principles

The Code-Point polygons are derived from ADDRESS-POINT®, the Ordnance Survey dataset that provides National Grid reference (NGref) coordinates for each postal delivery address in Great Britain. A process is undertaken to create a set of polygons around individual postcodes. This is called a [Thiessen process](#) and the polygons are the result of a mathematical computation that creates polygons from point data. In this way, mathematically-consistent boundaries are created between distinct postcode groups, creating this notional boundary set.

Postcode unit boundaries are, by definition, only the delivery point or collection of delivery points that constitutes the postcode units. The boundary is therefore a notional one, the position of which is arbitrary. What has been created, however, is a set of boundaries that follow a consistent logic and portray the notional footprint of each postcode unit, enclosing every delivery address for which positional data of sufficient quality is available, and which follow major physical features that could reasonably be regarded as part of the postcode boundary.

The quality of this polygon creation allows the polygons to be used for a wide range of applications. This will include analysis of geographically based information or statistics by postcode and the pictorial display of information that has been analysed or sorted by postcode.

The Code-Point CD is supplied with the polygon CD to provide a complementary set of point references for each postcode. The two datasets will both be created from the same edition of ADDRESS-POINT, ensuring that their data is synchronous.

Using Code-Point with polygons

The uses of Code-Point georeferenced postcode data are covered in the [Code-Point user guide](#) specifically produced for use with that product. This user guide will only focus on the use of the unit postcode polygons.

The polygons provide a boundary around the addresses within postcode units and so can be used to relate any occurrence or point within that boundary to the postcode concerned.

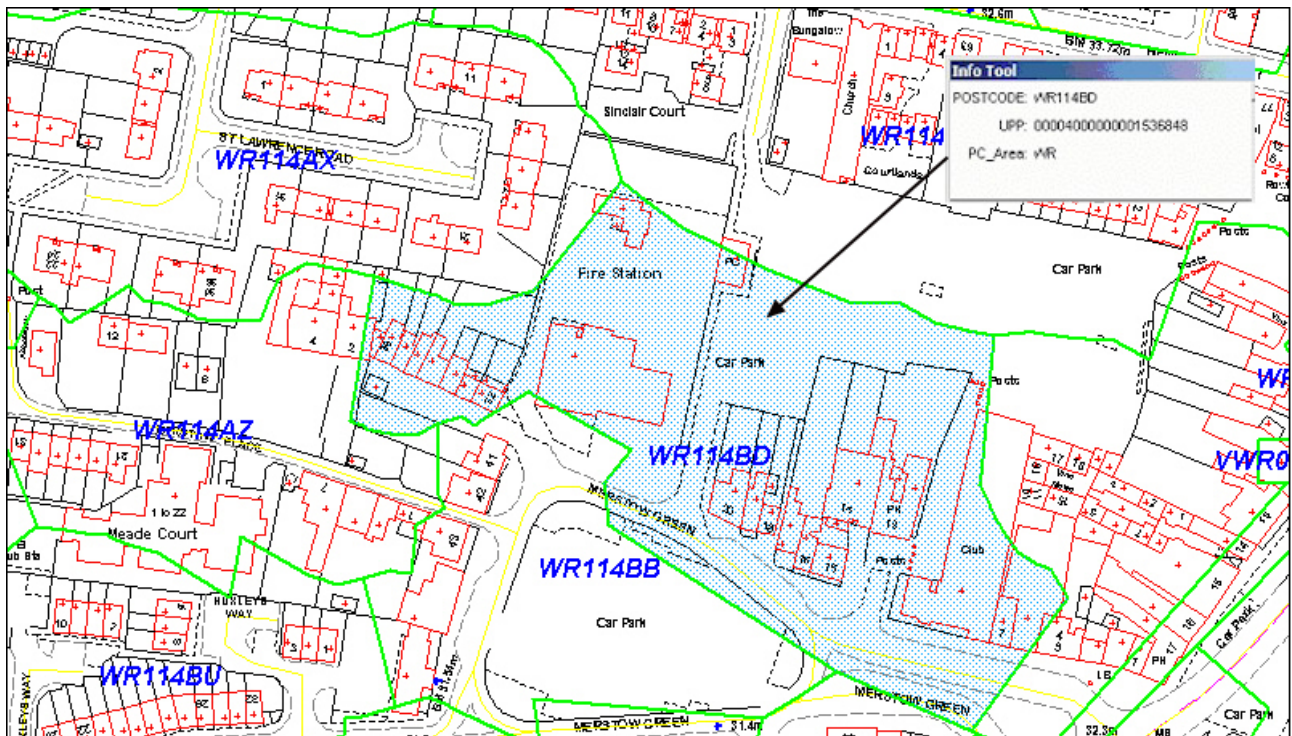

Where data is already analysed by postcode, a pictorial representation – for example, using a colour scheme – that will differentiate between postcodes or groups of postcodes can be obtained:

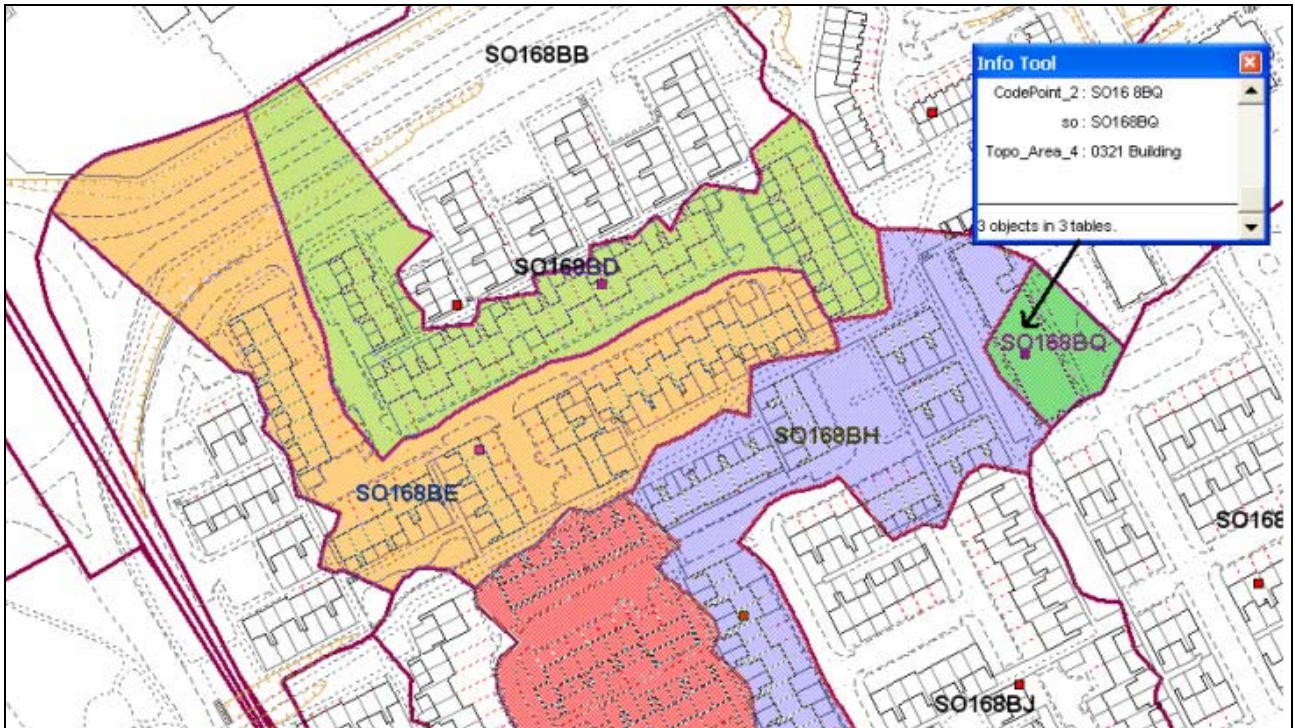

Chapter 3 Code-Point with polygons explained

This chapter contains an overview of the polygons; a full description of the polygon specification is located in the [polygon technical specification](#).

Description of the polygon set:

- The set is produced by the tessellation (or tiling) of ADDRESS-POINT coordinates for individual Royal Mail delivery addresses.
- Only addresses in ADDRESS-POINT having a positional quality (PQ) value of 3 are used to create the polygons file. Postcodes of addresses of lower quality will be included in the discard files.

Due to the nature of postcode geography, the polygons representing some postcode units are unavoidably split. Every effort has been made to ensure the absolute minimum of postcodes is represented by multiple polygons. Furthermore, these split polygons representing a single postcode remain a single object with one set of attributes. When this occurs, any issues arising will depend upon the mapping package used and the nature of its use. Typically, users may see only one of the group polygons labelled; however, it is worth checking the labelling options in your mapping package. If, however, the user was to query the polygon(s) or display associated data (using the postcode as a link field), all the split parts of a polygon would correctly represent the associated attributes. An example of such a polygon is shown on this page, with seed ADDRESS-POINT locations for that postcode shown in red:

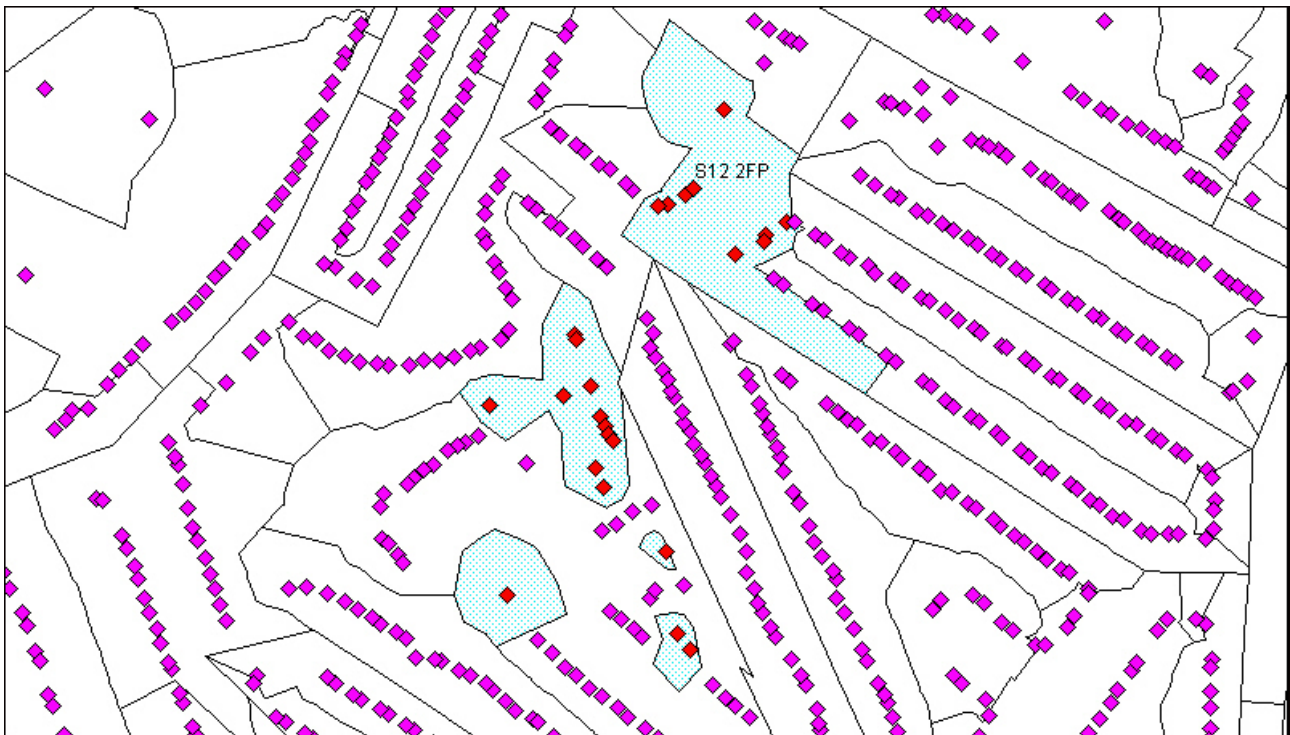

- Each polygon is assigned a unique identifier. The identifier will be a 16-digit series. These identifiers are not reused should a polygon be deleted.
- The polygon dataset contains non-overlapping polygon coverage of Great Britain, originally constrained by the extent of realm (EOR) coastline from Ordnance Survey's Boundary-Line™ data and Geoplan postcode polygons. Should any addresses fall outside the constraining datasets, the postcodes should be included in the discard files.
- As a result of the complex creation specification, there may be some rare occurrences of polygons or areas enclosed by polygons without a postcode allocation.
- The Code-Point CD contains a *read-me* file that provides information regarding the currency of the data used, including the date of the version of ADDRESS-POINT and the Postcode Address File (PAF®) release therein.
- The data is divided into 120 postcode area files, each file named with a one- or two-letter postcode area code.

- Where two or more postcodes are associated with a single building seed, a single distinctive square polygon will represent all the postcodes attached to the seed. These polygons have a special series of identifiers, all commencing with the letter **V**. A separate vertical streets look-up table lists the postcodes and their 16-digit unique identifier that are represented by each special polygon. Where these distinctive polygons are crowded closely together, they are reduced in size to prevent overlaps hiding some of the polygons.

Example showing two vertical streets and, on the right, an extract from the vertical streets look-up table:

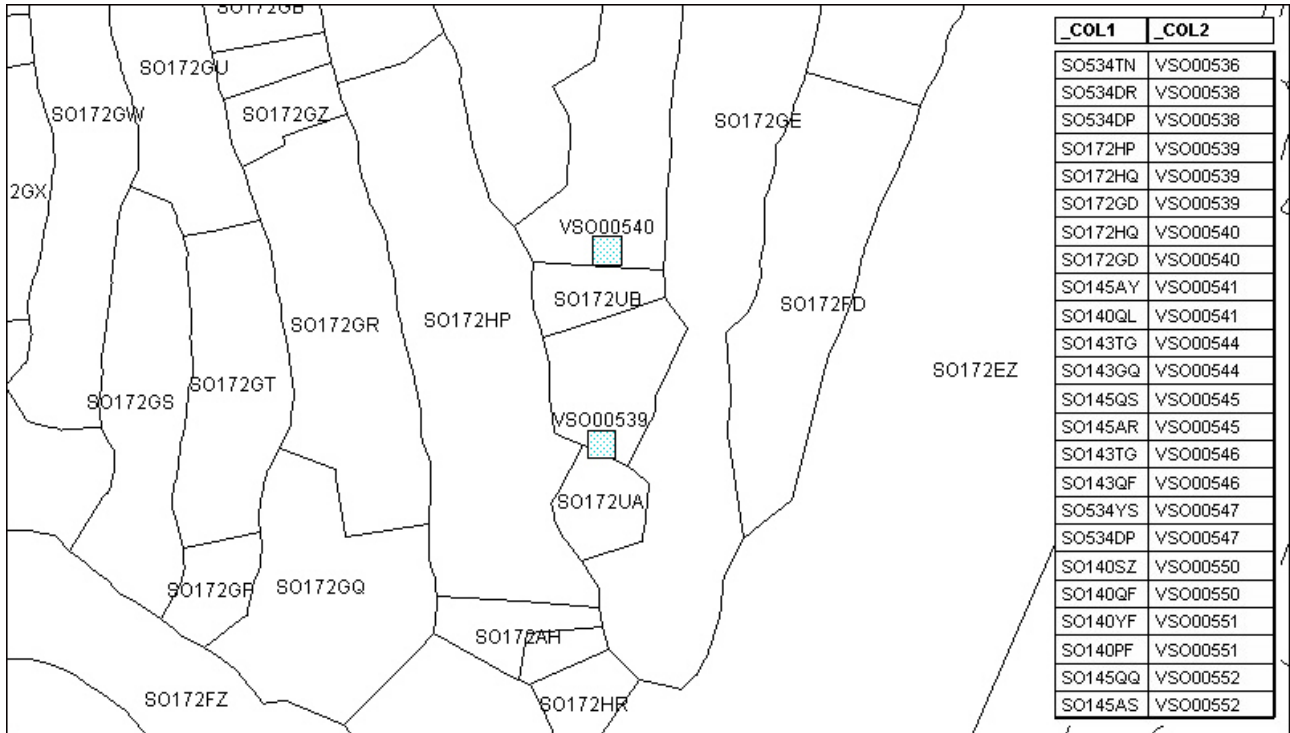

Chapter 4 Creating single-space postcodes

Centroids and polygons

Outward and inward bound representation

The current specification represents the postcodes in a set format which defines the postcodes as having an inward and outward postcode 'code'. Code-Point and Code-Point with polygon postcodes have 0, 1 or 2 spaces between the in and out code.

The table below identifies how postcodes are currently shown in the data.

Postcode structure	Number of spaces
AANNNA	0 spaces (represented as AANNNA) for example: PO143RW
ANN NAA	1 space (represented as ANN<>NAA) for example: PO14 3RW
AN NAA	2 spaces (represented as AN<><>NAA) for example: B1 5AP

Single-space postcodes

The Code-Point and Code-Point with polygons postcodes are currently represented as above; however, there may be a user requirement to represent each postcode in a uniformed single-space format.

The aim of this section is to offer some guidance on how to process the Code-Point and the related Code-Point with polygons data to generate postcodes with a single space.

The single-space instructions are applicable to both the postcode point and unit polygon products. Microsoft® Excel, Microsoft Access, MapInfo® and ESRI® GIS formats have been included to provide guidance when using CSV and other formats.

The underlying theory for all of the methods is principally the same, in that all current spaces are removed and then a single space added before the third character from the right.

NOTE: the NTF format is not included in this chapter as it is not compatible to a single-space format.

Also, that these instructions only apply to postcode units only, and not to vertical streets (which are only found in the Code-Point with polygons dataset). To ensure that the vertical street references are not corrupted, remove them from your data before applying these instructions.

CSV single-space postcodes using Microsoft Excel and Access

- Open the CSV file with Excel so that the data is displayed in columns.
In a new blank column, click in the first cell of the new column (excluding the row column names).
- In the function line enter in the following function command where A1 is the column containing the postcode:
=TRIM(LEFT(A1,LEN(A1)-3))&" "&RIGHT(A1,3)

This should now produce a column containing postcodes with a single space. For polygon data, extend this formula downwards, stopping when you reach any vertical street references, for example, those beginning with 'V'.

The same method can be employed in Microsoft Access, using an update query rather than the function line. The functions listed above are the same for Access and Excel.

MID/MIF and TAB single-space postcodes using MapInfo

The process within MapInfo is the same regardless of whether the original supply is in TAB or MID/MIF as both get imported to MapInfo and opened as a .TAB file.

- First, open the Code-Point data in MapInfo and add a new column to hold the formatted postcode.

To add a column to the TAB file.

- Click on *Table, Maintenance, Table Structure*.

This opens the following Modify Table Structure dialogue box:

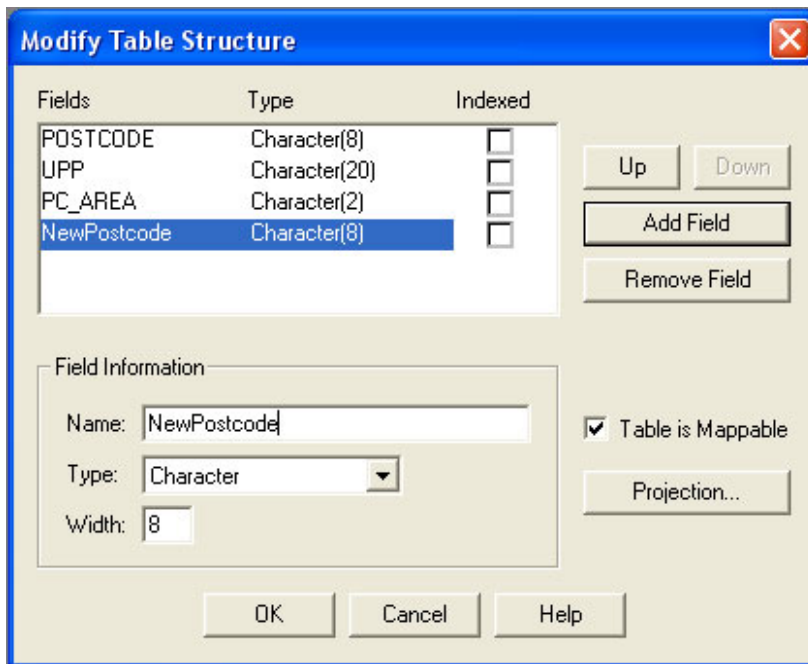

NOTE: if the Add Field / Remove Field buttons are missing then it may be necessary to save a copy of the table and alter the copy.

- Click on *Add Field*.

This adds a field to the end of the table.

- *Name* the new column 'NewPostcode' and give it a *Type* of 'Character' and a *Width* of '8'.
- Click the *OK* button to apply the changes.

If using polygon data, the next stage is to ensure that only postcode units are updated and not any vertical street references that might also be in the table.

- Click on *Query, Select*.

This brings up the Select Query dialogue box:

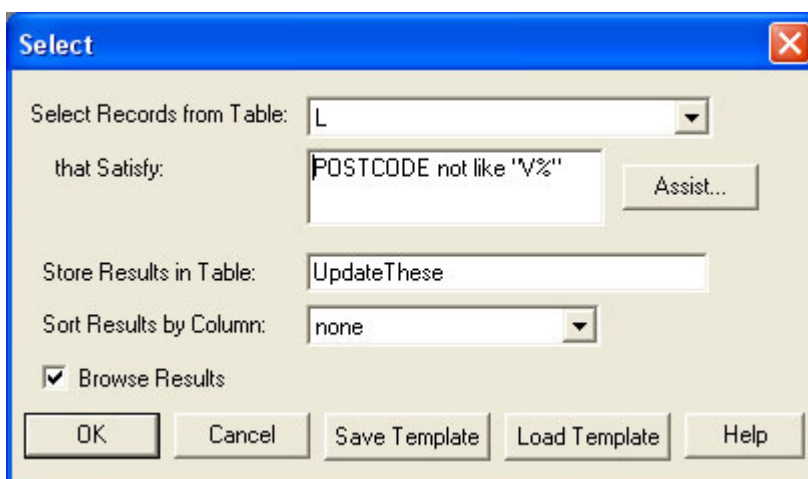

- Ensure that the correct table is being selected from, in this example, 'L' and enter the following expression in the 'that Satisfy' field:

POSTCODE not like "V%"

- Change the *Store Results in Table* field to read 'UpdateThese'.
- Click the *OK* button to apply the query.

The final stage is to update the new column.

- Click *Table* and then the *Update column* tab.

This opens the following dialogue box:

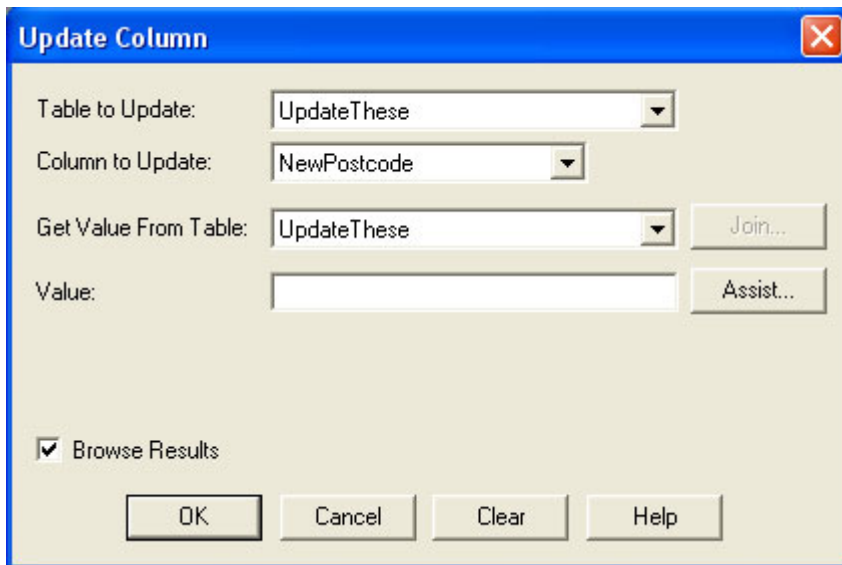

- Ensure that the field *Table to Update* field has 'UpdateThese' as it's value.
- From the *Column to Update* drop down menu select the previously added column 'NewPostcode' making sure the *Get Value from Table* is the same table as in the *Table to Update* field.
- Click the *Assist* button.

This opens the following Expression dialogue box:

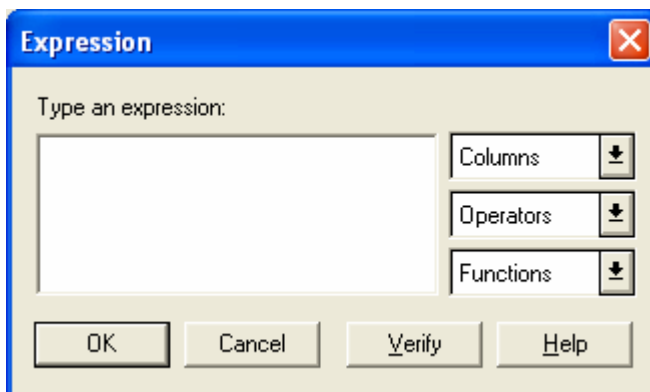

- In the *Type an expression* box, key in the following function command:
RTrim\$(Left\$(Postcode,(Len(Postcode)-3))) + " " + Right\$(Postcode,3)
- Click the *OK* button to apply the update.

This will update your new column with a single-space postcode.

Shapefile single-space postcodes using ESRI ArcGIS

These steps are based on the assumption that the data has already been imported into ArcGIS® and that the user has the correct permissions to edit the Shapefile. It is advised to try this method on a copy of the original data, and not the only copy of the data, in case of error.

Once the Shapefile is open, the required new fields can be added.

- Right-click on the layer in the *Table of Contents* (down the left-hand side of the map window) and open the *Open Attribute Table*.

The first step is to add a new column to hold the newly-formatted postcode.

- Click on the *Options* button then click on *Add Field*.

This opens the following dialogue box:

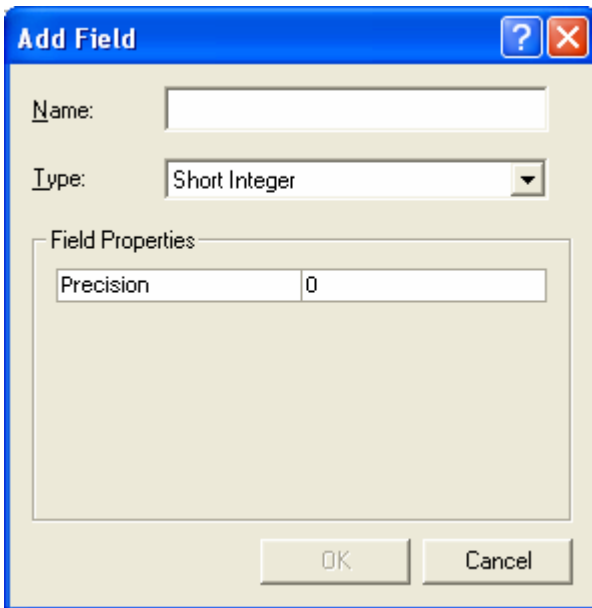

- Key in an appropriate name, for example, 'NewPC', in the *Name* box and change the *Type* box on the drop down menu to 'text'; also change the *Field Properties* Precision/Length to '8'.
- Click *OK* and the field is added.

The next stage is to ensure that only postcode units are updated and not any vertical street references that might also be in the table.

- Click on *Selection, Selection By Attributes*.

This brings up the *Select By Attributes* dialogue box:

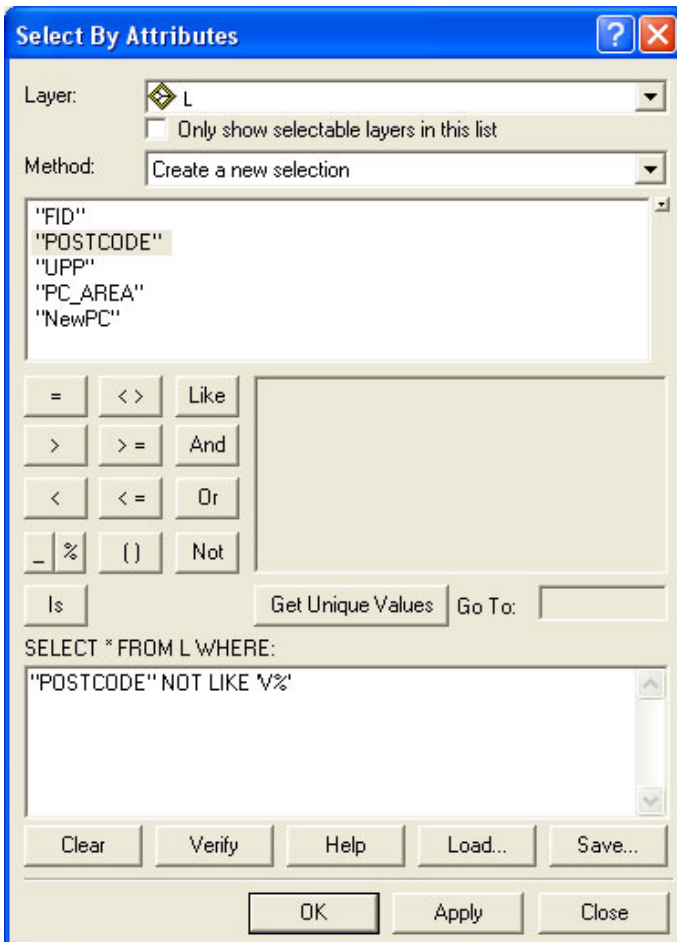

- Ensure that the correct *Layer* is being selected from, in this example, 'L'.
- Ensure that the *Method* field you have chosen is 'Create a new selection'.
- Then, enter the following expression in the query field at the bottom of the dialogue box:
"POSTCODE" NOT LIKE 'V%'
- Click the *OK* button to apply the query.

This selects all the postcodes that are not vertical streets from the *attribute* table.

The final stage is to update the new column.

In order to populate the fields, the table has to be made editable.

Return to the map window. Do not close the attribute table as it will be required later.

Click on the *Editor* drop down selection = ▼.

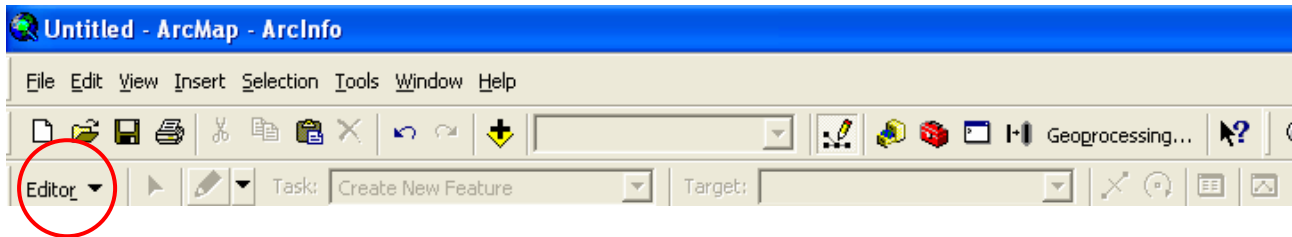

If this toolbar is not already loaded, then right click on an empty part of the grey area on the map window and all the available toolbars will be listed. Simply click on the *Editor* tool bar and it will be loaded to the toolbar.

- Click the *Editor* drop down and select the first option, *Start Editing*.
- Once *Start Editing* has been selected, return to the attribute table.
- Right-click on the column name of the column added previously, for example, 'NewPC', and select *Calculate Values*.

This opens the following *Field Calculator* dialogue box:

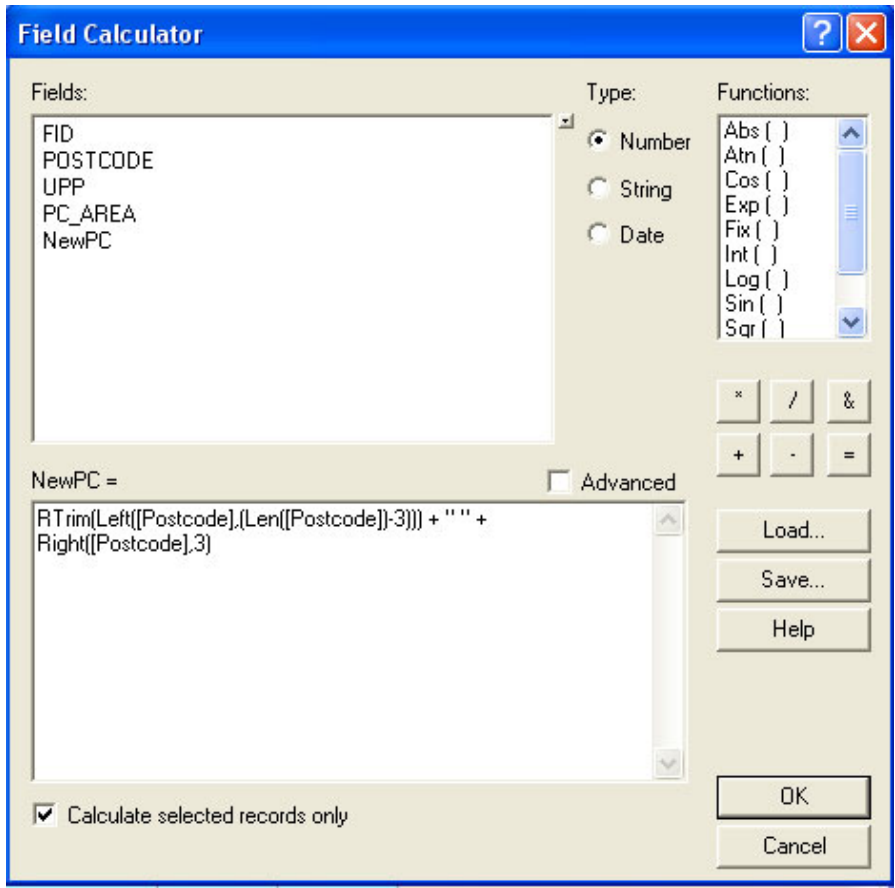

- In the bottom dialog box, enter in the following function command:
RTrim(Left([Postcode],[Len([Postcode])-3])) + " " + Right([Postcode],3)
- Ensure that the lower left tick box *Calculate selected records only* is checked.
- Click *OK* to update the column. This will update your new column with a single-space postcode.

Finally go back to the map window, click on the *Editor* tool bar and select *Stop editing*. It will prompt to save the edits. Click *Yes*.

Chapter 5 Data measures

Ordnance Survey measures the data in its products in one or more of the ways set out in table 1 below.

Table 1 Definitions of data measures

Data measure	Definition	Sub-measure	Definition
Completeness	Presence and absence of features against the specified data content*	Omission	Features representing objects that conform to the specified data content but are not present in the data
		Commission	Features representing objects that do not conform to the specified data content but are present in the data
Logical consistency	Degree of adherence to logical rules of data structure, attribution and relationships	Conceptual consistency	How closely the data follows the conceptual rules (or model)
		Domain consistency	How closely the data values in the dataset match the range of values in the dataset specification
		Format consistency	The physical structure (syntax): how closely the data stored and delivered fits the database schema and agreed supply formats
		Topological consistency	The explicit topological references between features (connectivity) – according to specification
Positional accuracy	Accuracy of the position of features	Absolute accuracy	How closely the coordinates of a point in the dataset agree with the coordinates of the same point on the ground (in the British National Grid reference system)
		Relative accuracy	Positional consistency of a data point or feature in relation to other local data points or features within the same or another reference dataset
		Geometric fidelity	The 'trueness' of features to the shapes and alignments of the objects they represent*
Temporal accuracy	Accuracy of temporal attributes and temporal relationships of features	Temporal consistency	How well ordered events are recorded in the dataset (life cycles)
		Temporal validity (currency)	Validity of data with respect to time: the amount of real-world change that has been incorporated in the dataset that is scheduled for capture under current specifications
Thematic accuracy (attribute accuracy)	Classification of features and their attributes	Classification correctness	How accurately the attributes within the dataset record the information about objects*

*When testing the data according to the dataset specification against the 'real world' or reference dataset.

Annexe A Case studies

Sharing data across the NHS® to improve patient services

NHS North West was established under government policy to strengthen primary care trusts (PCTs) and give GPs greater ability to commission or purchase health services directly for their patients. The organisation replaced the three former strategic health authorities in Cumbria and Lancashire, Cheshire and Merseyside, and Greater Manchester. Association of Greater Manchester PCTs is taking forward a data analysis and reporting tool called the TIS Analyser, which was developed by Greater Manchester health organisations as part of the Tactical Information Service (TIS). Read more at:

http://www.ordnancesurvey.co.uk/oswebsite/business/sectors/health/docs/sharing_data.pdf

Annexe B Metadata

ISO 19115 compliant UK GEMINI discovery level metadata is provided for the data and can be found on the Glgateway® (www.glgateway.org.uk)

The following is a detailed description of the metadata elements that are provided on the Glgateway:

Title: The title of the product.

Abstract: The abstract gives a brief description of the product.

Currency: The currency takes the form of date of last update for the feature.

Lineage: The lineage metadata takes the form of product specification name and date of product specification.

Spatial extent: The spatial extent is supplied in the form of geographic identifiers (for example, England, Scotland and Wales) and in the form of geographic coordinates.

Spatial reference system: The spatial reference system for all products takes the form of a British National Grid system, namely OSGB36®.

Data format: Data format takes the form of the name of the format or formats the product is supplied in.

Frequency of updates: Frequency of update takes the form of a stated period of time.

Distributor contact details: Distributor contact details include with postal address, phone number, fax number, email address and website.

Data originator: Given as the company having primary responsibility for the intellectual content of the data source; in all cases this will be Ordnance Survey.

Other metadata available includes keywords, start date of data capture, access constraints, use constraints, level of spatial data, supply media and presentation details.

Annexe C Product and service performance report form

Ordnance Survey welcomes feedback from its customers about Code-Point with polygons.

If you would like to share your thoughts with us, please print a copy of this form and when completed post or fax it to the address below.

Your name:

Organisation:

Address:

.....

.....

Postcode:

Phone:

Fax:

Email:

Quotation or order reference:

Please record your comments or feedback in the space below. We will acknowledge receipt of your form within three (3) working days and provide you with a full reply or a status report within 21 working days.

If you are posting this form, please send it to:

Code-Point with polygons Product Manager, Ordnance Survey, Adanac Drive, SOUTHAMPTON, SO16 0AS.

If you wish to return it by fax, please dial 08450 990494.

Any personal information that you supply with this report form will be used by Ordnance Survey only in the improvement of its products and services. It will not be made available to third parties.

Code-Point with polygons

Technical specification

Contents

Section	Page no	
Introduction	21	
Purpose of this specification and disclaimer	21	
Copyright in this specification	21	
Using this specification	21	
Chapter 1	Background information	22
What you need to use Code-Point with polygons	22	
Hardware	22	
Software	22	
Code-Point with polygons supply	22	
Update	22	
Transfer format(s)	22	
Media, data compression	22	
Code-Point with polygons version numbering	22	
Chapter 2	Specification	23
Lineage	23	
Content	23	
Code-Point with polygons product structure	23	
Structure of the Code-Point with polygons CD-ROM	24	
Completeness	24	
Logical consistency	24	
Medium	25	
Chapter 3	MapInfo® Formats	26
MID/MIF	26	
MapInfo TAB	26	
Chapter 4	ESRI® format	27
Shapefile	27	
Annexe A	Glossary	28

v2.11 – 11/2010

Introduction

Purpose of this specification and disclaimer

This is the technical specification (hereafter referred to as the specification) applicable to the Code-Point with polygons product (hereafter referred to as the product) which is referred to in the Framework Direct Licence, Specific Use Framework Partner Licence or your other customer contract for the product.

Copyright in this specification

This specification, (including for the avoidance of doubt any mapping images reproduced herein), is © Crown copyright 2010. All rights reserved.

Any part of this specification may be copied for use internally in your organisation or business so that you can use Code-Point with polygons for the purpose for which it is licensed to your organisation or business (but not otherwise).

No part of this specification may be reproduced or transmitted in any form or by any means (including electronically) for commercial exploitation without the prior written consent of Ordnance Survey.

No part of this specification may be copied or incorporated in products, services or publications that you generate for onward sale, or as free promotional or support materials, without the prior written consent of Ordnance Survey.

Using this specification

The documentation is supplied in portable document format (PDF) only. Free Adobe® Acrobat Reader® software, which displays the specification, incorporates search and zoom facilities and allows you to navigate within. Hyperlinks are used to navigate between associated parts of the specification and to relevant Internet resources by clicking on the blue hyperlinks and the table of contents.

If you are unfamiliar with any words or terms used and require clarification please refer to the [Glossary](#) at the end of the document.

Chapter 1 Background information

This is the specification referred to in the Framework Direct Licence, Specific Use Framework Partner Licence or other customer contract.

This technical specification provides detailed technical information that is designed to help you fully understand the data structure of Code-Point with polygons.

What you need to use Code-Point with polygons

Hardware

Code-Point is a data product and does not include software for analysis, but can be used with a variety of programs. Code-Point can be loaded onto any desktop PC. Consult your geographical information system (GIS) vendor to establish actual system requirements.

Software

Most proprietary GIS packages will suffice, for example, MapInfo, ESRI or Autodesk® products.

Code-Point with polygons supply

The polygon data coverage is Great Britain, the associated Code-Point coverage is for United Kingdom, as it includes Northern Ireland postcodes.

Update

Updates will normally be at three-monthly intervals and are a complete resupply of the national dataset.

Transfer format(s)

Code-Point polygons are available in the following formats, the preferred choice of which will be influenced by the software used:

- ESRI Interchange format Shapefile
- MapInfo Interchange format MID/MIF
- MapInfo Table file format TAB

Media, data compression

Code-Point with polygons is supplied on CD-ROM. The Code-Point polygon files (only) contain substantial amounts of information, which in both Shapefile and MID/MIF formats necessitate that file compression be used. Code-Point with polygons data is currently supplied in a Zip files.

Code-Point with polygons version numbering

Each edition of Code-Point with polygons will have a version number showing the release month for the year (for example, 4) followed by the release year (for example, 2009).

Starting from April 2009, the version for each quarterly release will be in this format:

- April 2009
- July 2009
- October 2009
- January 2010

Within the Code-Point with polygons product set, the Code-Point data and the polygons will have their own version numbering for example, Code-Point with polygons April 2009 release will be supplied alongside a set of Code-Point version 2009.1.0. Both Code-Point and the polygons are initially sourced from the same version of ADDRESS-POINT and PAF.

Chapter 2 Specification

Lineage

Ordnance Survey adds National Grid coordinates to the PAF address records for Great Britain, mainly to 0.1 m resolution, and other information to produce the product called ADDRESS-POINT. This unique product provides highly accurate positioning of all postal addresses in Great Britain.

ADDRESS-POINT is then used to create both Code-Point and the Code-Point unit postcode polygons.

Content

Code-Point with polygons contains:

- Code-Point georeferenced postcode unit data, with associated metadata such as address counts and quality indicators. Also provided are the health and administrative area codes related to each postcode. The coverage of the Code-Point data is the whole of the United Kingdom and it is provided in both CSV (comma separated values) format and NTF (National Transfer Format).
- Also provided, in association with the Code-Point data, is a text file that provides the full text equivalents of the administrative area codes, and another that provides the numbers of postcode units in each postcode area.
- Postcode unit polygons depicting notional boundaries around each postcode unit in Great Britain. This data is supplied in either Shapefile or MID/MIF formats.
- Also provided, in association with the polygon data, are two sets of CSV text files:
 - Vertical streets – a list of polygons, identified by a serial number that is prefixed by the letter V, which contain more than one postcode. This situation can occur in, for example, blocks of flats where there is more than one postcode within a single building.
 - Discards – a list of the postcodes for which polygons have not been included because there is no data of sufficient quality to use in the polygon creation, or because their constituent addresses lie outside the extent of the realm (coastline). Also in the discard file are PO boxes – a list of the PO box postcodes, none of which will have been used in the creation of the polygon set.
- An DOC folder, containing files called *CD_INFO.TXT*, *Readme.TXT* and *DISCCARE.TXT*, is also part of the CD-ROM file structure. For more information, please see [Structure of the Code-Point with polygons CD-ROM](#).

Code-Point with polygons product structure

The polygon product CD-ROM(s), contains two folders: *DOC* and *Data*.

The DOC folder contains the following files:

- *CD_INFO.TXT* – notes about the data on this CD-ROM (this file)
- *Readme.TXT* – licence, copyright and specification change information.
- *DISCCARE.TXT* – information on the care of CDs.

The DATA folder contains the following subfolders:

- *Polygons* – containing polygon data in 120 postcode area files (either MID/MIF or Shapefile).
- *Vertical streets* – a look-up table of 120 text files of vertical street reference codes and the postcodes contained in them.
- *Discards* – a look-up list of 120 text files of the postcodes that have not been included in the polygon creation process because either there are no ADDRESS-POINT records of sufficient PQ classification or they are PO Box postcodes.

These files are contained on the accompanying Code-Point CD:

- *Metadata* – lists the number of postcode units in each postcode area and the date of the most recent version of the Royal Mail PAF that has been incorporated into the data.
- *Codelist* – a list of the Office of National Statistics (ONS) county, district and ward codes and their full text equivalents.
- *Code-Point* – containing Code-Point point data in two sets of 121 postcode area files (both CSV and NTF).
- The user guide to accompany this product can be downloaded from the Code-Point with polygons product page, found at www.ordnancesurvey.co.uk.

Structure of the Code-Point with polygons CD-ROM

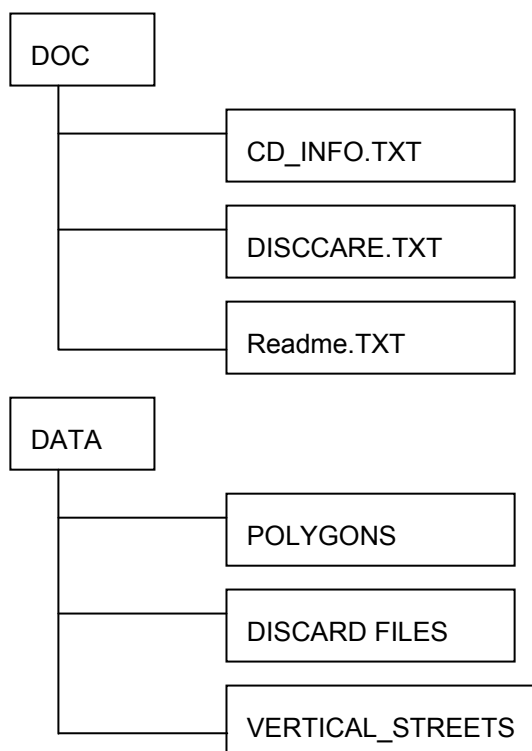

Completeness

The Code-Point product contains a point reference for every postcode unit in England, Scotland, Wales and Northern Ireland that is contained in Royal Mail's PAF product at the time of creation of the dataset.

The polygon set contains a polygon for every postcode in England, Scotland and Wales that is contained in Royal Mail's PAF product, with the following exceptions:

- postcodes for which there is no data of sufficient quality in ADDRESS-POINT;
- postcodes for which there is no data that lies within the extent of the realm coastline in ADDRESS-POINT;
- some postcodes fall outside the extent of the realm; also some fall outside of the Geoplan postcode boundaries, for example, Loch Lomond;
- postcodes that relate to PO boxes; and
- postcodes that are vertically stacked, that is, two or more postcodes within a single building that are represented by a single large-scale building seed. In these situations, a single square polygon represents all the postcodes attributed to the single building seed.

Logical consistency

The logic used to create both the Code-Point centroid point and polygon data is consistent across the whole of each dataset.

Medium

Code-Point with polygons is supplied on CD-ROM, ISO 9660.

Chapter 3 MapInfo® Formats

MID/MIF

The transfer format is as defined by the *MapInfo Professional User's Guide: MIF Export*. MapInfo Interchange Format (MIF) is an ASCII file format that can fully describe a MapInfo database. Both graphic and tabular data are exported into MIF files. The graphic data is in a file with a *.mif* extension, and the tabular data is in a file with a *.mid* extension.

MapInfo Interchange Format files can be translated into other formats with other programs.

An overview of the data structure of a Boundary-Line file in MID/MIF is shown below:

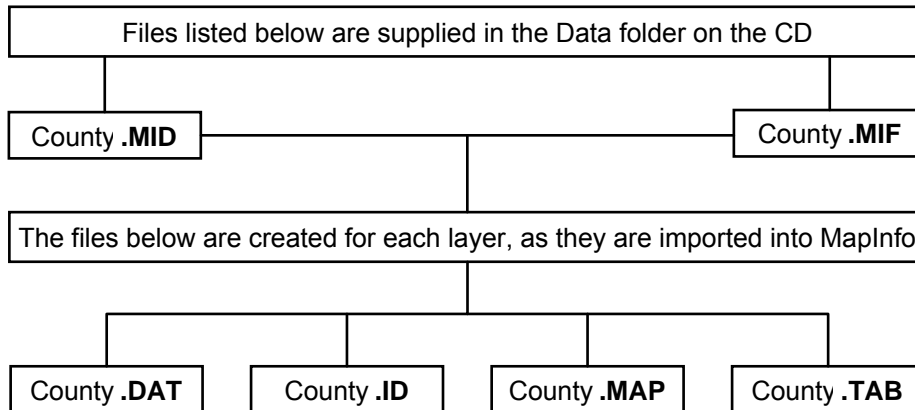

MapInfo Interchange Format files can be translated into other formats with other programs.

MID/MIF fields

Field Name	Type	Width	Description
POSTCODE	Char	8	Full postcode from Code-Point
UPP	Char	20	Unique polygon identifier
PC_AREA	Char	2	

Example of MID/MIF;

```
"TA15 1PL",00004000000001389232","TA"
```

MapInfo TAB

TAB files (MapInfo tables) are the native format of MapInfo. They consist of a number of files with extensions such as *.DAT*, *.ID*, *.MAP* and *.TAB*; all of these files need to be present and kept together for the table to work.

TAB fields

Field Name	Type	Width	Description
POSTCODE	Char	8	Full postcode from Code-Point
UPP	Char	20	Unique polygon identifier
PC_AREA	Char	2	

Example of TAB;

```
"TA15 1PL",00004000000001389232","TA"
```

Chapter 4 ESRI® format

Shapefile

ESRI Shapefile is a simple, non-topological format for storing the geometric location and attribute information of geographic features. A Shapefile is one of the spatial data formats that can be worked with in ArcGIS.

The Shapefile format defines the geometry and attributes of geographically-referenced features in as many as five files with specific file extensions that should be stored in the same project workspace.

They are:

.shp – the file that stores the feature geometry.

.shx – the file that stores the index of the feature geometry.

.dbf – the dBASE file that stores the attribute information of features.

When a Shapefile is added as a theme to a view, this file is displayed as a feature table.

.sbn and **.sbx** – the files that store the spatial index of the features.

.prj – the file that stores the projection information

These two files will only exist if you perform theme-on-theme selection, spatial joins, or create an index on a theme's SHAPE field.

Shapefile fields

Field Name	Type	Width	Description
*FID			
*Shape	Polygon		
POSTCODE	Char	8	Full postcode from Code-Point
UPP	Char	20	Unique polygon identifier
PC_AREA	Char	2	

Example of Shapefile "0", "Polygon", "TA15 1PL", 00004000000001389232", "TA"

NOTE: the Shapefile format automatically adds fields to show the values for: surface area, perimeter and region identifiers (internal), for example, the Shapefile file for postcode HG will also feature the following fields: AREA, PERIMETER, HG_REGION_ and HG_REGI

NOTE*: these fields are not in the data, as they are virtual columns created by ArcGIS when accessing the table contents. The FID column uniquely identifies each object stored in the table. The SHAPE column provides information about the feature geometry.

Annexe A Glossary

addressed premise

A permanent or non-permanent building structure with an address being a potential delivery point for Royal Mail. Examples of an addressed premise would be: a house, a flat within a block of flats, a caravan site, a bollard to which several houseboats may be moored, or an organisation occupying the whole of a building.

ADDRESS-POINT

An Ordnance Survey text data product that relates Royal Mail Postcode Address File (PAF) addressed properties within Great Britain to the National Grid.

area-based postcode

A type of large-user postcode that is allocated to a small number of organisations who receive an exceptionally large amount of mail. These postcodes still relate to a geographic area but may overlap other sector areas or be scattered.

building

A physical, walled structure connected to foundations that has, or will have, a roof. This definition includes buildings surveyed at foundation stage.

Code-Point

Code-Point provides a precise geographic location for each postcode unit in the United Kingdom.

CPLC (Code-Point location coordinate)

A National Grid reference for each unit postcode. It is a two-dimensional coordinated point to a resolution of 1 metre. Coordinates are attributed from ADDRESS-POINT using an accuracy hierarchy.

Comma separated values (CSV)

The CSV file format is commonly used to exchange data between different applications, for example, Microsoft Excel and Access. Being a text file, CSV files can also be viewed in *Notepad*.

delivery point

A Royal Mail-defined point to which mail is delivered. This may be a property (private address), organisation, mailbox or even the name of an individual. These categories are derived from *The Complete Guide to Postcode Products* from Royal Mail. This is distinct from the addressed premise because there may be more than one organisation at an address.

Discard file

These are postcodes for which polygons have not been included because there is no data of sufficient quality to use in the polygon creation, or because their constituent addresses lie outside the extent of the realm (coastline). Also in the discard file are PO boxes – a list of the PO box postcodes, none of which will have been used in the creation of the polygon set.

Gridlink[®]

Gridlink is the name given to a joined-up government initiative involving Royal Mail, the Office for National Statistics (ONS), the General Register Office for Scotland (GROS), Land & Property Services and Ordnance Survey. All these organisations are involved in the georeferencing of postcodes and the relating of postcodes to administrative and National Health Service areas.

inward code or incode

See [postcode](#).

Large-scale data

Ordnance Survey's definitive large-scale maps in digital form. A comprehensive dataset, depicting man-made and natural features ranging from houses, factories, roads and rivers to marshland and administrative boundaries, surveyed and digitised at three different scales according to location:

- 1:1250 scale in urban areas;
- 1:2500 scale in rural areas; and
- 1:10 000 scale for remote areas, such as mountains and moorland.

large-user postcode

A large-user postcode is normally allocated when:

- a firm or business at a new address regularly receives, in any one day, 25 or more items of mail in a town area or 50 or more items in a rural area;
- a private box (PO box) is provided;
- Royal Mail Selectapost service is provided;
- a Business Reply or Freepost licence is taken out; or
- all Freepost and Business Replies have their own postcode.

matched address

An address, resulting from a match between the OS MasterMap Topography Layer data and the PAF, which has been allocated a coordinate position. The match may be a result of either manual or automatic matching, the latter encompassing both full and 'fuzzy-logic' matching.

National Grid reference (NGref)

The National Grid provides a unique reference system that can be applied to all Ordnance Survey maps of Great Britain. The map of Great Britain is covered by 100 m by 100 km grid squares, with the origin lying to the west of the Isles of Scilly. When a National Grid reference is quoted, the easting (left to right direction) is always given before the northing (upwards direction).

A National Grid reference (to 1 metre) will identify the spatial position of the [CPLC](#) (Code-Point location coordinate).

National Transfer Format (NTF)

A vector interchange format used to distribute digital map products from Ordnance Survey that conforms to BS 7567 (Electronic transfer of geographic information (NTF)).

outward code or outcode

See [postcode](#).

PAF (Postcode Address File)

The PAF was created when all the separately held information was assembled and stored on a Royal Mail central computer system. PAF now contains the postal addresses and postcodes of approximately 26 million delivery points in Great Britain, including approximately 222 000 large users.

Positional Quality (PQ)

The PQ is a flag to indicate the positional accuracy of the Gridlink coordinates allocated to each postcode record.

All postcodes are to 1-m resolution, but Gridlink will seek to provide the most accurate coordinates according to the hierarchy detailed in the following table.

Status value	Description of status values
1	Automatically calculated to be within the building of the matched address closest to the postcode mean.
2	As for status value 1, except by visual inspection of OS MasterMap [®] Topography Layer maps.
3	Approximate to within 50 m of true position.
4	Postcode unit mean – (mean of matched addresses with the same postcode, but not snapped to a building).
5	Postcode inputted by ONS by reference to surrounding known postcodes.
6	Postcode sector mean – mainly PO boxes
8	Postcode terminated. No postcodes of this type will be provided by Gridlink, nor should they be provided to Gridlink. Consortium members may wish to hold this information for historical purposes. The accuracy of the data is as indicated by its status value immediately prior to its termination.
9	No coordinates available.

postal address

A postal address is a delivery point that is currently receiving mail. There may be many delivery points within an individual building structure as shown in OS MasterMap Topography Layer data.

postcode

An abbreviated form of address made up of combinations of between five and seven alphanumeric characters. A postcode may cover between 1 and 100 addresses. The average number of addresses per postcode is 15.

There are two main components of a postcode:

- The outward code (also called outcode). The first two to four characters of the postcode constituting the postcode area and the postcode district. It is the part of the postcode that enables mail to be sent from the accepting office to the correct area for delivery.
- The inward code (also called incode). The last three characters of the postcode constituting the postcode sector and the postcode unit. It is used to sort mail at the local delivery office.

For example:

Outward		Inward	
NW	6	4	DP
			Postcode unit
		Sector	
	District		
Area			

postcode area

An area given a unique alphabetic coding by Royal Mail to facilitate the delivering of mail. The area is identified by one or two alpha characters at the start of the full postcode, the letters being derived from a town, city or district falling within the postcode area. There are at present 120 postcode areas in Great Britain, for example, SO for Southampton, MK for Milton Keynes, B for Birmingham or W for London West. The postcode area code constitutes the first part of the outward code.

postcode district

A sub-area of the postcode area, specified by the character sub-string within the first half of a full postcode, which may be numeric, alphabetic or alphanumeric; for example, 42 from MK42 6GH or 1A from W1A 4WW. There are approximately 2 800 postcode districts in Great Britain.

NOTE: there are certain non-geographic districts. In these instances, a district code is allocated to cover all large users in the postcode area.

postcode sector

A sub-area of a postcode district whose area is identified by the number third from the end of a full postcode. There are approximately 9 000 postcode sectors in Great Britain. An example of a postcode sector code is 3 from GU12 3DH.

postcode unit

A sub area of a postcode sector, indicated by the two letters of the inward postcode, which identifies one or more small-user postcode delivery points or an individual large user postcode. There are approximately 1.6 million unit postcodes in the UK.

post office (PO) box

Generally, a non-geographic address allocated with a number by the Post Office®. PO boxes within ADDRESS-POINT are now matched to the Royal Mail delivery office at which they are based (except in the Northern Ireland postcode area) rather than the average of location-matched addresses within the postcode sector.

Postzon®

A file marketed by Royal Mail that allocates a National Grid reference to each postcode unit. This coordinate is derived from a 100-metre square that contains the first of the range of addresses that form the unit postcode.

Theissen polygons

A method of mathematically transforming point data into thematic maps based not on predetermined reporting units but rather on proximity of the distribution of points. One of the points that defines the edges of a Thiessen polygon is always the nearest neighbour to the point in the centre of the polygon.

vertical streets

For example, a blocks of flats where there is more than one postcode within a single building. These are identified in the data by a serial number prefixed with a V.