

**reports** by **emapsite**<sup>™</sup>



Better reports and data for site investigation

# Fast-track Utility Search Report

**For the following location:**

Growing Concerns Garden Centre, 2 Wick Lane,  
Tower Hamlets, Greater London, E3 2NA

**Client:**

Caroline Walker

**Co-ordinates:**

536905.000,184116.200

**Reference:**

EMS00347/1953602

**Search Date:**

11/03/2015

**emapsite**<sup>™</sup>

 **Technics**  
Geospatial Consultant Surveyors

 [www.emapsite.com](http://www.emapsite.com)

 0118 973 6883

 [info@emapsite.com](mailto:info@emapsite.com)

Thank you for your Utility Search Report order. You have selected one of several report options developed to suit the specific needs of our different customers. The range comprises:

## Utility Essentials

The Utility Essentials report gives visibility of the 5 key services – Gas, Electric, Water, Sewage and British Telecom, supplied for areas of up to 25 hectares. The Essentials report is ideal for remote sites where only the main utilities providers are likely to be present or projects where the aim is merely to check the availability of the main utilities e.g. in the planning stages of a new development. All available information is collated and delivered as a single report in 5 working days with any outstanding information being delivered as soon as it is available.

## Utility Premium

The Utility Premium report provides comprehensive information about all services affecting your site, including: Gas and Oil Pipelines; mains Water and Sewerage; Telecoms and fibre-optic cables; and transportation networks. This report is ideal when comprehensive information is required for your site, ensuring you are managing your risk and avoiding expensive delays. Supplied for areas of up to 25 hectares, all available information is gathered, collated and supplied as a single report within 10 working days, with any outstanding information being delivered as soon as it is available. Please note, a search of Vtesse Networks Ltd is not included in this report. If you require a Vtesse Networks Ltd search this is available through our Utility Singles Telecoms report.

## Utility Fast-track

The Utility Fast-track report delivers all the information of a Premium report (Gas and Oil Pipelines; mains Water and Sewerage; Telecoms and fibre-optic cables; and transportation networks) but with all available supplier responses being collated in a report and delivered to you within 5 working days, with any outstanding information being delivered as soon as it is available. Please note, a search of Vtesse Networks Ltd is not included in this report. If you require a Vtesse Networks Ltd search this is available through our Utility Singles Telecoms report.

## Utility Singles

Our Utility Singles reports enable you to request data for a single utility type. You can order Gas, Water & Sewerage, Electricity or Telecoms as an individual search. This is a cost-effective way to obtain relevant information if you only need to check the availability/position of a particular utility in order to plan a new development or make changes to an existing development. Supplied for areas of up to 25 hectares\*, all available information is gathered, collated and supplied as a single report within 10 working days, with any outstanding information being delivered as soon as it is available.

\*Telecom report with Vtesse is limited to a maximum radius of 250m.

## UTILITY REPORT CONTENT & INFORMATION

### 1 Purpose of Utilities Report

The Utilities Report is intended to be for project planning and feasibility only. It is not suitable to be used for construction or excavation purposes. The existence of utilities on the plans does not imply that they are suitable in size, capacity, type or location for the project purpose. The Utility Companies should be contacted directly for clarification in this regard.

### 2 Compilation of the Utilities Report

The Utilities Report is a compilation of Utility Company record plans. These are obtained via application to the Utility Companies following a geographic search to determine which Companies are in a given area. The data is provided by the Utility Companies in a variety of formats including faxed plans, pdf files, digital drawing files and paper drawings. They are all converted to pdf files for inclusion in the report. The quality of the plans therefore varies. A quality assured process is followed for each report. This requires that it is checked at different stages during the process before being subjected to a final assessment prior to issue.

### 3 Limitations and Accuracy of the data

Each Utility Company has its own disclaimer statement in respect of the information they provide. They do not guarantee or provide a warranty for the data. The Utility Company disclaimers should be referred to when considering the accuracy and completeness of the data. Generally the plans provided are for guidance only and are not guaranteed to be up to date or to be a complete record of the Utility Company plant in a given area.

Some Utility Companies only show main utilities. Therefore service pipes or cables may not be shown on the plans but they may be present on the site.

Some Utility Companies state that the utilities may deviate from the route and position shown on the plans.

Due to the time delay between installation of, or repair or upgrading of utilities and the subsequent updating of the Utility Companies plans, it should be noted that there could be utilities present that are not shown on the plans.

The user shall make further enquires and investigations to satisfy himself as to the adequacy of the plans and position of the utilities. The exact position of the utilities should be verified by the use of suitable detecting devices and safe digging practices in accordance with HS(G)47. Further advice on the location of the utilities should be requested from the owner.

### 4 Completeness

Whilst every effort is made to locate all Utility Companies in a given area, due to the sensitive or restrictive nature of certain sites, the existence of redundant utilities, the emergence of new companies and the combining of, takeover or sale of existing Companies, we cannot guarantee to provide details on all utilities in a given area.

### 5 Date

Due to the Utility Companies plans being regularly changed and updated, the Utility Report is only valid at the time of production.

### 6 Liability

For the reasons given in 1 – 5 above neither emapsite Ltd nor Technics Group Limited (trading name of Subtechnics Limited) can accept any liability for or offer any guarantees for the report or the content. No representation is made by either emapsite Ltd and/or Technics Group Limited as to the accuracy, completeness, sufficiency or otherwise of this report.

### 7 Copyright

The copyright of the Utilities Report remains with Technics Group Limited and may not be copied nor communicated using any method either in whole or in part without the prior written consent of Technics Group Limited.

### 8 Assignment

The Utility Report cannot be assigned to any other party without the prior written consent of Technics Group Limited.

## Terms and Conditions

The Terms and Conditions should be read in conjunction with the 'Report Content & Information' sheet. The content of the 'Report Content & Information' sheet forms part of the Terms and Conditions.

### 1. Disbursements

- 1.1. Several Utility Companies charge for either searching to determine if they have any plant or for providing plans. These charges are included in the cost of Utility Essentials, Utility Premium and Utility Fast-track Reports, and are not charged as extra. Utility Singles Reports do not include disbursement charges and these will be charged as extra to the client at cost. The client will be made aware of any applicable charges prior to finalisation of purchase.
- 1.2. The Utility Companies that make a charge or the charges themselves may be changed or updated without notification to the client.

### 2. Turnaround times

- 2.1. Whilst every effort is made to produce the reports as quickly as possible we are reliant on the Utility Companies to provide us with the plans and/or data. Depending on the product purchased, generally reports are completed within approximately 5 to 15 working days.
- 2.2. No guarantees can be made regarding the time taken to complete the report.

### 3. Limitation of Liability

- 3.1 Technics Group Ltd (trading name of Subtechnics Limited) and/or emapsite Ltd will make all reasonable endeavors to provide the Utility Report within the stated time period and shall not be liable for any delay arising because of any act, omission or delay of any Utility Company.
- 3.2 The Utility Companies have no liability to Technics Group Ltd and/or emapsite Ltd in relation to the provision of information, plans and/or data or the omission of or to provide such information, plans or data. Therefore Technics Group Ltd and/or emapsite Ltd shall have no liability to a Client for the information, plans and data contained in a Utilities Report.
- 3.3 Technics Group Ltd and/or emapsite Ltd shall have no liability in relation to any Utilities Report for loss or damage arising in relation to loss of profits, loss of business, loss of use, costs, damages, charges or expenses.

### 4. Cancellation Policy

- 4.1. We are unable to cancel the order once finalised.

### 5. Force Majeure

Technics Group Ltd and/or emapsite Ltd will have no liability to the Client if it is prevented from or delayed in performing its obligations in connection with producing the Utilities Report by any act, event, omission, accident or incident beyond its reasonable control. These include but are not limited to:- any form of industrial dispute, strike or lock-out, breakdown or failure of a utility service or transport network, act of God, war, riot, civil commotion, malicious damage, accident, incident, breakdown of plant, machinery or electronic system, fire or flood.

### 6. Governing Law

The Governing Law and Jurisdiction of these Terms and Conditions, any Contract or Agreement are governed by and construed in accordance with the laws of England and Wales. The courts of England and Wales shall have non-exclusive jurisdiction to settle any dispute or claim that arises out of or in connection with these Terms and Conditions, any Contract or Agreement.

Our Ref

GRS00347/GS-1953602

Grid Reference

OSGB: 536905.000,184116.200

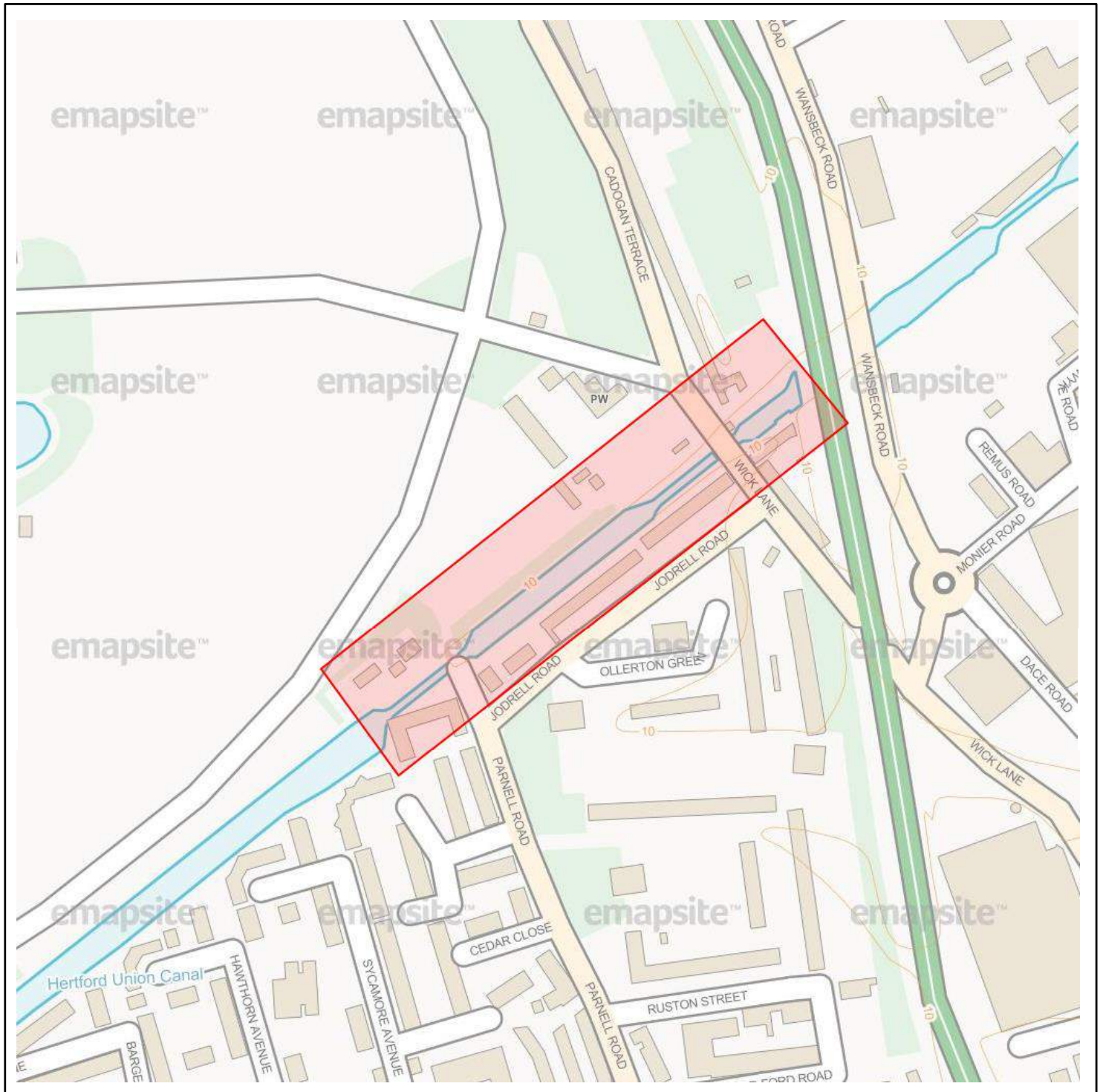

© Crown copyright, All rights reserved 2010. License number 0100031673

Produced by the Ordnance Survey National Geographic Database and incorporating surveyed revision available at the date of production.

Reproduction in whole or in part is prohibited without the prior permission of Ordnance Survey.

The representation of a road, track or path is no evidence of a right of way.

The representation of features as lines is no evidence of a property boundary.

## Utility Company Underground Services Results Schedule

Your Ref                    1953602

Our Ref:                    EMS00347

Address:                    Growing Concerns Garden Centre, 2 Wick Lane

Grid Reference:            536905.000,184116.200

Post code:                E3 2NA

Author:                    Stephen Sawyer

Search Date:              11/03/2015

Utility Company	Responses	Outcome
<b>Electricity</b>		
UK Power Networks	31	Affected
National Grid UK	8	Affected
Energetics	1	Not Affected
ESP Utilities Group	3	Not Affected
GTC Pipelines	3	Not Affected
<b>Gas</b>		
National Grid UK	11	Affected
Energetics	1	Not Affected
ESP Utilities Group	3	Affected
GTC Pipelines	3	Affected
<b>Telecoms/Cable</b>		
Zayo Europe	3	Affected
Atkins Global	1	Not Affected
Easynet	1	Affected
Gamma Telecom Limited	1	Not Affected
Telent	2	Affected
Instalcom	1	Not Affected
Interoute	1	Not Affected
KCOM	1	Not Affected
McNicholas	2	Affected
Verizon	1	Not Affected
Virgin Media	2	Affected
Radio and Freeview Transmitters	2	Not Affected
BT	1	Affected

Oil/Fuel		
LineSearch	1	Not Affected
Other		
Trafficmaster	1	Not Affected
Transport for London - London Streets	1	Not Affected
Transport		
London Underground	1	Not Affected
Network Rail	1	Not Affected
Water and Sewers		
Thames Water	1	Affected



# Electricity



Mr. Stephen Sawyer  
Technics Group  
Technics House  
Merrow Business Centre  
Merrow Lane  
Guildford  
GU4 7WA

Our Ref: 2015/2181896  
Your Ref: GRS00347  
12/03/2015

Dear Sir/Madam

**GROWING CONCERNS GARDEN CENTRE 2, WICK LANE, LONDON, E3 2NA**

Thank you for your letter of 11/03/2015 in which you asked if there are any electric lines and/or electrical plant belonging to UK Power Networks (LPN) plc ("UK Power Networks") within land referred to by your enquiry. Unfortunately I have not been able to determine the specific site to which your enquiry relates. I have thus provided records for the land to which I believe your enquiry may refer. If the records provided do not relate to the land to which you had intended to refer please resubmit your enquiry, showing the relevant land edged red on a plan which clearly shows the entirety of the land for which you require copies of our records. It will help me to identify the land to which your enquiry relates if you could also provide me with a copy or page from an A to Z map, showing both the land itself and the area in which it is located.

Subject to the above, I enclose a copy of UK Power Networks record of its electric lines and/or electrical plant at the site. If the records provided do not relate to the land to which you had intended to refer please resubmit your enquiry.

This information is made available to you on the terms set out below.

- 1. UK Power Networks does not warrant that the information provided to you is correct. You rely upon it at your own risk.**
- UK Power Networks does not exclude or limit its liability if it causes the death of any person or causes personal injury to a person where such death or personal injury is caused by its negligence.
- Subject to paragraph 2 UK Power Networks has no liability to you in contract, in tort (including negligence), for breach of statutory duty or otherwise how for any loss, damage, costs, claims, demands, or expenses that you or any third party may suffer or incur as a result of using the information provided whether for physical damage to property or for any economic loss (including without limitation loss of profit, loss of opportunity, loss of savings, loss of goodwill, loss of business, loss of use) or any special or consequential loss or damage whatsoever.**
- The information about UK Power Networks electrical plant and/or electric lines provided to you belongs to and remains the property of UK Power Networks. You must not alter it in any respect.
- The information provided to you about the electrical plant and/or electric lines depicted on the plans may NOT be a complete record of such apparatus belonging to UK Power Networks. The information provided relates to electric lines and/or electrical plant belonging to UK Power Networks that it believes to be present but the plans are NOT definitive: other**

**electric lines and/or electrical plant may be present and that may or may not belong to UK Power Networks.**

6. **Other apparatus not belonging to UK Power Networks is not shown on the plan. It is your responsibility to make your own enquiries elsewhere to discover whether apparatus belonging to others is present. It would be prudent to assume that other apparatus is present.**
7. You are responsible for ensuring that the information made available to you is passed to those acting on your behalf and that all such persons are made aware of the contents of this letter.
8. Because the information provided to you may **NOT** be accurate, you are recommended to ascertain the presence of UK Power Networks electric lines and/or electrical plant by the digging of trial holes. **Trial holes should be dug by hand only.**

Excavations must be carried out in line with the Health and Safety Executive guidance document HSG 47. We will not undertake this work. A copy of HSG 47 can be obtained from the Health and Safety Executives website.

**All electric lines discovered must be considered LIVE and DANGEROUS at all times and must not be cut, resited, suspended, bent or interfered with unless specially authorised by UK Power Networks.**

**The electric line and electrical plant belonging to UK Power Networks remains so even when made dead and abandoned and any such electric line and/or electrical plant exposed shall be reported to UK Power Networks.**

**Where your works are likely to affect our electric lines and/or electrical plant an estimate of the price of any protective /diversionary works can be prepared by UK Power Networks Branch at Metropolitan House, Darkes Lane, Potters Bar, Herts. , EN6 1AG, telephone no. 0845 2340040**

9. **Any work near to any overhead electric lines must be carried out by you in accordance with the Health and Safety Executive guidance document GS6 and the Electricity at Work Regulations.**

The GS6 Recommendations may be purchased from HSE Books or downloaded from the Energy Networks Association's website.

If given a reasonable period of prior notice UK Power Networks will attend on site without charge to advise how and where "goal posts" should be erected. If you wish to avail yourself of this service, in the first instance please telephone: 0845 6014516 between 08:30 and 17:00 Monday to Friday, Public and bank holidays excepted.

10. You are responsible for the security of the information provided to you. It must not be given, sold or made available upon payment of a fee to a third party.
11. If in carrying out work on land in, on, under or over which is installed an electric line and/or electrical plant that belongs to UK Power Networks you and/or anyone working on your behalf damages (however slightly) that apparatus you must inform immediately UK Power Networks by telephone at the number below providing:
  - your name, address and telephone number; and
  - the date, time and place at which such damage was caused; and

- a description of the electric line and/or electrical plant to which damage was caused; and
- the name of the person whom it appears to you is responsible for that damage; and
- the nature of the damage

**Telephone 0800 780078 (24 Hours).**

12. The expression “UK Power Networks” includes UK Power Networks (EPN) plc, UK Power Networks (LPN) plc, UK Power Networks (SEPN) plc, UK Power Networks and any of their successors and predecessors in title.

IF YOU DO **NOT** ACCEPT AND/OR **DO NOT** UNDERSTAND THE TERMS OF USE SET OUT IN PARAGRAPHS 1 TO 12 INCLUSIVE ABOVE YOU MUST NOT USE THE PLANS AND RETURN THEM TO ME.

I would remind you that work adjacent to electric lines and/or electrical plant represents a serious risk to health and safety and as such should feature amongst the items you have assessed in your workplace risk assessment and method statement.

I shall be pleased to supply you with further assistance if you require it.

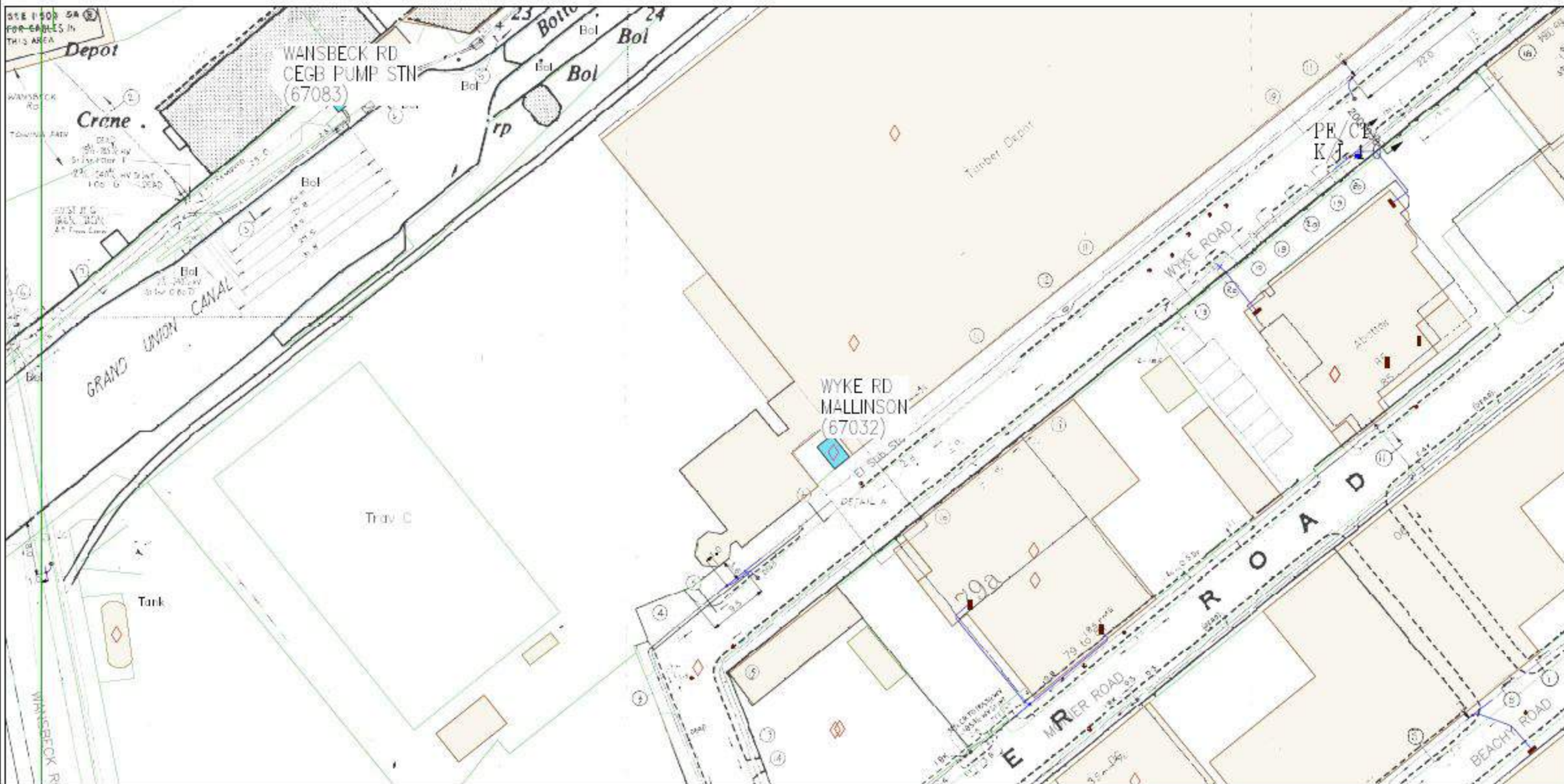

Printed On : 12/03/2015



File Description:

Map Centre : TQ57845W



For details of our cables please visit: <http://www.ukpowernetworks.co.uk/infocentre/underground-cables>

**PRIMARY CABLES**  
EXTRA HIGH VOLTAGE CABLES (EHV) 22,000 TO 132,000 Volts

Depth normally 750mm cover in carriageway & 600mm cover in footway.  
Before digging within one metre of these cables contact Telephone 0800 056 5866 in order that the Company's apparatus may be located at site and any necessary protection works agreed.  
**N.B. THRUST BOMBS OR HOLES MUST NOT BE USED WITHIN THE VICINITY OF ANY CABLES BELONGING TO UK POWER NETWORKS WITHOUT FIRST CONTACTING THIS COMPANY.**

1. The position of the apparatus shown on this drawing is believed to be correct but the original handbooks may have been altered since the apparatus was installed.
2. The exact position of the apparatus should be verified - use approved cable avoidance tools prior to excavation using suitable hand tools.
3. It is essential that trial holes are carefully made avoiding the use of mechanical tools or picks and the exact location of all cables have been determined.
4. It must be assumed that there is a service cable in each property, lamp column and street lighting etc.
5. All cables must be treated as being live unless proved otherwise by UK Power Networks.
6. The information provided must be given to all people working near UK Power Networks' plant & equipment. Do not use plants more than 3 months after the issue date for excavation.
7. Please be aware that electric cables/lines belonging to other owners of licensed electricity distribution systems may be present and it is your responsibility to identify their location.

1. UK Power Networks Ltd does not warrant that the information provided to you is correct. You rely upon it at your own risk.
2. UK Power Networks Ltd does not exclude or limit its liability if it causes the death of a person or causes personal injury to a person where such death or personal injury is caused by its negligence.
3. Subject to paragraph 2, UK Power Networks Ltd has no liability to you in contract, in tort (including negligence), for breach of statutory duty or otherwise howsoever for any loss, damage, costs, claims, demands or expenses that you or any third party may suffer or incur as a result of using the information provided whether for physical damage to property or for any economic loss (including without limitation loss of profits, loss of opportunity, loss of savings, loss of goodwill, loss of business, loss of use) or any special or consequential loss or damage whatsoever.

Reproduced by permission of Ordnance Survey on behalf of HMSO. (c) Crown copyright and database right 2015. All rights reserved. Ordnance Survey Licence number 100019626. Data has been added to the Ordnance Survey base map; all proprietary rights in such additional data are and shall remain the exclusive property of (c) Eastern Power Networks plc or London Power Networks plc each being a distribution licensee under section 5(1)(c) of the Electricity Act 1989 for the relevant distribution services area as that term is defined in such licensee's distribution licence. All rights in such data reserved.

**ADVICE TO CONTRACTORS ON AVOIDING DANGER FROM BURIED ELECTRICITY CABLES**

- 1) Do have cable drawings with you on site and check them before you start the excavation.
- 2) Do have a cable locator tool on site and use it to help you.
- 3) Mark out the location of electricity cables.
- 4) Do not use a mechanical excavator within 0.5m of electricity cables.
- 5) Use spades and shovels in preference to other tools.
- 6) Never disturb electricity cables and joints or their protective covers.

**IF IN DOUBT - ASK! PHONE 0800 056 5866**  
**BIG-BENCY - If you damage a cable or line**  
Phone 0800 780 0780 (24hrs) UK-BNLY

These basic safety precautions are explained in detail in the HSE booklet H52417 - Avoiding Danger from Underground Services, a copy of which may be obtained from your supervisor or HMSO.

Please be aware that electric lines belonging to other owners of licensed electricity distribution systems may be present and it is your responsibility to identify their location.

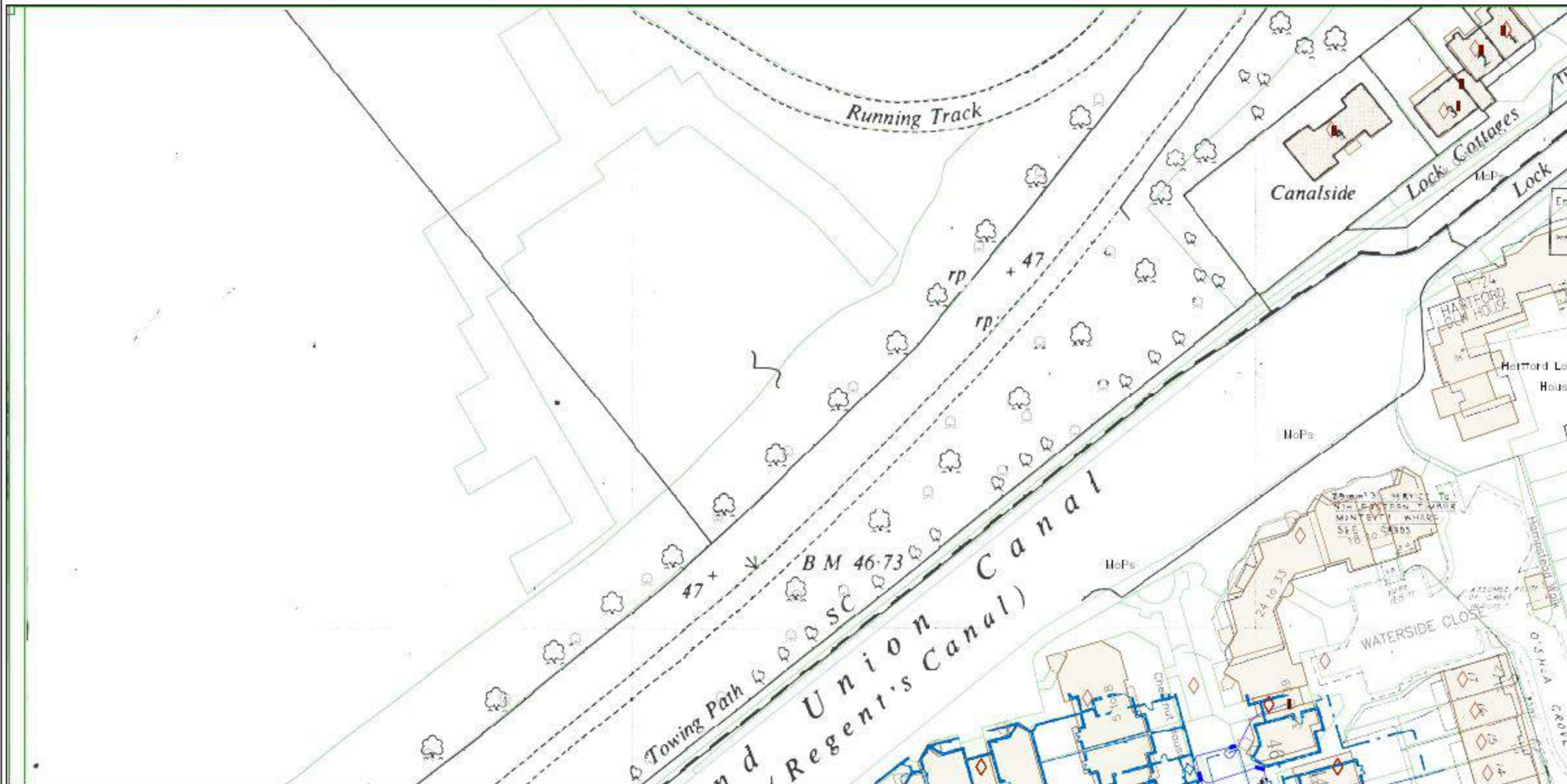

Plotted On: 12/03/2015



Plot Description:

Map Centre: T03083NE



**PRIMARY CABLES**  
EXTRA HIGH VOLTAGE CABLES (EHV) 22,000 TO 132,000 volts

Depth normally 750mm cover in cartway & 600mm cover in footway.  
Before digging within one metre of these cables notify  
Telephone 0800 056 5866 in order that the Company's apparatus may be located  
on site and any necessary protection works agreed.

**NO THURST BARRERS OR MOLES MUST NOT BE USED WITHIN THE VICINITY OF ANY CABLES BELONGING TO UK POWER NETWORKS WITHOUT FIRST CONTACTING THIS COMPANY.**

1. The position of the apparatus shown on this drawing is believed to be correct but the ground landmarks may have been altered since the apparatus was installed.
2. The exact position of the apparatus should be verified - use approved cable avoidance tools prior to excavation using suitable hand tools.
3. It is essential that trial holes are carefully made avoiding the use of mechanical tools or picks and the exact location of all cables have been identified.
4. It must be assumed that there is a service cable into each property, lamp column and street sign, etc.
5. All cables must be treated as being live unless proved otherwise by UK Power Networks.
6. The information provided must be open to all people working near UK Power Networks plant & equipment. Do not use plans more than 3 months after the issue date for excavation.
7. Please be aware that electric cables/lines belonging to other owners of licensed electricity distribution systems may be present and it is your responsibility to identify their location.

1. UK Power Networks Ltd does not warrant that the information provided to you is correct. You rely upon it at your own risk.
2. UK Power Networks Ltd does not exclude or limit its liability if it causes the death of a person or causes personal injury to a person where such death or personal injury is caused by its negligence.
3. Subject to paragraph 2, UK Power Networks Ltd has no liability to you in contract, in tort (including negligence), for breach of statutory duty or otherwise howsoever for any loss, damage, costs, claims, demands or expenses that you or any third party may suffer or incur as a result of using the information provided whether for physical damage to property or for any economic loss (including without limitation loss of profit, loss of opportunity, loss of savings, loss of goodwill, loss of business, loss of use) or any special or consequential loss or damage whatsoever.

Reproduced by permission of Ordnance Survey on behalf of HMSO. (c) Crown copyright and database right 2015. All rights reserved. Ordnance Survey license number 100019626. Data has been added to the Ordnance Survey base map; all proprietary rights in such additional data are and shall remain the exclusive property of (c) Eastern Power Networks plc or London Power Networks plc each being a distribution licensee under section 5(1)(c) of the Electricity Act 1989 for the relevant distribution services area as that term is defined in such licensee's distribution licence. All rights in such data reserved.

**ADVICE TO CONTRACTORS ON AVOIDING DANGER FROM BURIED ELECTRICITY CABLES**

- 1) Do have cable drawings with you on site and check them before you start the excavation.
- 2) Do have a cable locating tool on site and use it to help you.
- 3) Mark out the location of electricity cables.
- 4) Do not use a mechanical excavator within 0.5m of electricity cables.
- 5) Use spades and shovels in preference to other tools.
- 6) Never disturb electricity cables and joints or their protective covers.

**IF IN DOUBT - ASK PHONE 0800 056 5866**  
**BIG-ENERGY - If you damage a cable or line**  
Phone 0800 780 0780 (24hrs) UK-ONLY

These basic safety precautions are explained in detail in the HSE booklet H52(4)7 - Avoiding Danger from Underground Services, a copy of which may be obtained from your supervisor or HMSO.

Please be aware that electric lines belonging to other owners of licensed electricity distribution systems may be present and it is your responsibility to identify their location.

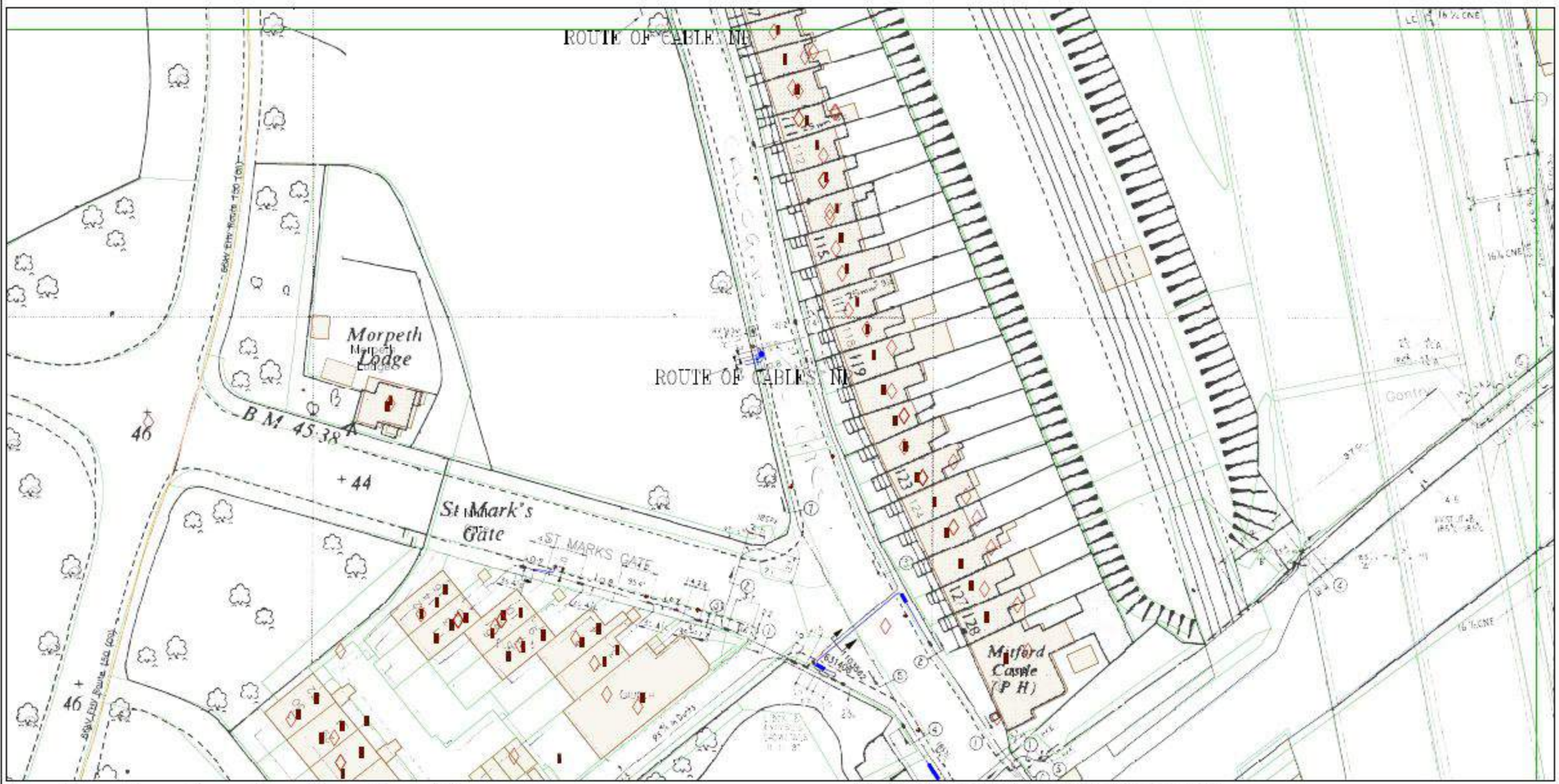

Filed On : 12/03/2015



File Description :

Map Centre : TQ3684SE



**PRIMARY CABLES**  
**EXTRA HIGH VOLTAGE CABLES (EHV) 22,000 TO 132,000 Volts**

Depth normally 750mm cover in subhighway & 600mm cover in footway.  
 Before digging within the limits of these cable routes Telephone 0800 056 5866 in order that the Company's apparatus may be located on site and any necessary protection works agreed.

**N.B. THRUST BORDERS OR HOLES MUST NOT BE USED WITHIN THE VICINITY OF ANY CABLES BELONGING TO UK POWER NETWORKS WITHOUT FIRST CONTACTING THIS COMPANY.**

1. The position of the apparatus shown on this drawing is believed to be correct but the original landmarks may have been altered since the apparatus was installed.
2. The exact position of the apparatus should be verified by use approved cable avoidance tools prior to excavation using suitable hand tools.
3. It is essential that trial holes are carefully made avoiding the use of mechanical tools or picks until the exact location of all cables have been determined.
4. It must be assumed that there is a service cable into each property, lamp column and street sign etc.
5. All cables must be treated as being live unless proved otherwise by UK Power Networks.
6. The information provided must be given to all people working near UK Power Networks plant & equipment. Do not use plants more than 3 months after the issue date for excavation.
7. **Caution:**
8. Please be aware that electric cables/lines belonging to other owners of licensed electricity distribution systems may be present and it is your responsibility to identify their location.

1. UK Power Networks Ltd does not warrant that the information provided to you is correct. You rely upon it at your own risk.  
 2. UK Power Networks Ltd does not exclude or limit its liability in it causes the death of a person or causes personal injury to a person where such death or personal injury is caused by its negligence.  
 3. Subject to paragraph 2, UK Power Networks Ltd has no liability to you in contract, in tort (including negligence), for breach of statutory duty or otherwise howsoever for any loss, damage, costs, claims, demands or expenses that you or any third party may suffer or incur as a result of using the information provided whether for physical damage to property or for any economic loss (including without limitation loss of profit, loss of opportunity, loss of savings, loss of goodwill, loss of business, loss of use) or any special or consequential loss or damage whatsoever.

Reproduced by permission of Ordnance Survey on behalf of HMSO. (c) Crown copyright and database right 2015. All rights reserved. Ordnance Survey Licence number 100019826. Data has been added to the Ordnance Survey base map; all proprietary rights in such additional data are and shall remain the exclusive property of (c) Eastern Power Networks plc and London Power Networks plc each being a distribution licensee under section 5(1)(c) of the Electricity Act 1989 for the relevant distribution services area as that term is defined in such licensee's distribution licence. All rights in such data reserved.

**ADVICE TO CONTRACTORS ON AVOIDING DANGER FROM BURIED ELECTRICITY CABLES.**

- 1) Do have cable drawings with you on site and check them before you start the excavation.
- 2) Do have a cable locator tool on site and use it to help you.
- 3) Mark out the location of electricity cables.
- 4) Do not use a mechanical excavator within 0.5m of electricity cables.
- 5) Use spades and shovels in preference to other tools.
- 6) Never disturb electricity cables and joints or their protective covers.

**IF IN DOUBT - ASK! PHONE 0800 056 5866**  
**EMERGENCY - If you damage a cable or line**  
 Phone 0800 760 0760 (24hrs) **URGENTLY**

These basic safety precautions are explained in detail in the HSE booklet H52417 - Avoiding Danger from Underground Services, a copy of which may be obtained from your supervisor or HMSO.

Please be aware that electric lines belonging to other owners of licensed electricity distribution systems may be present and it is your responsibility to identify their location.

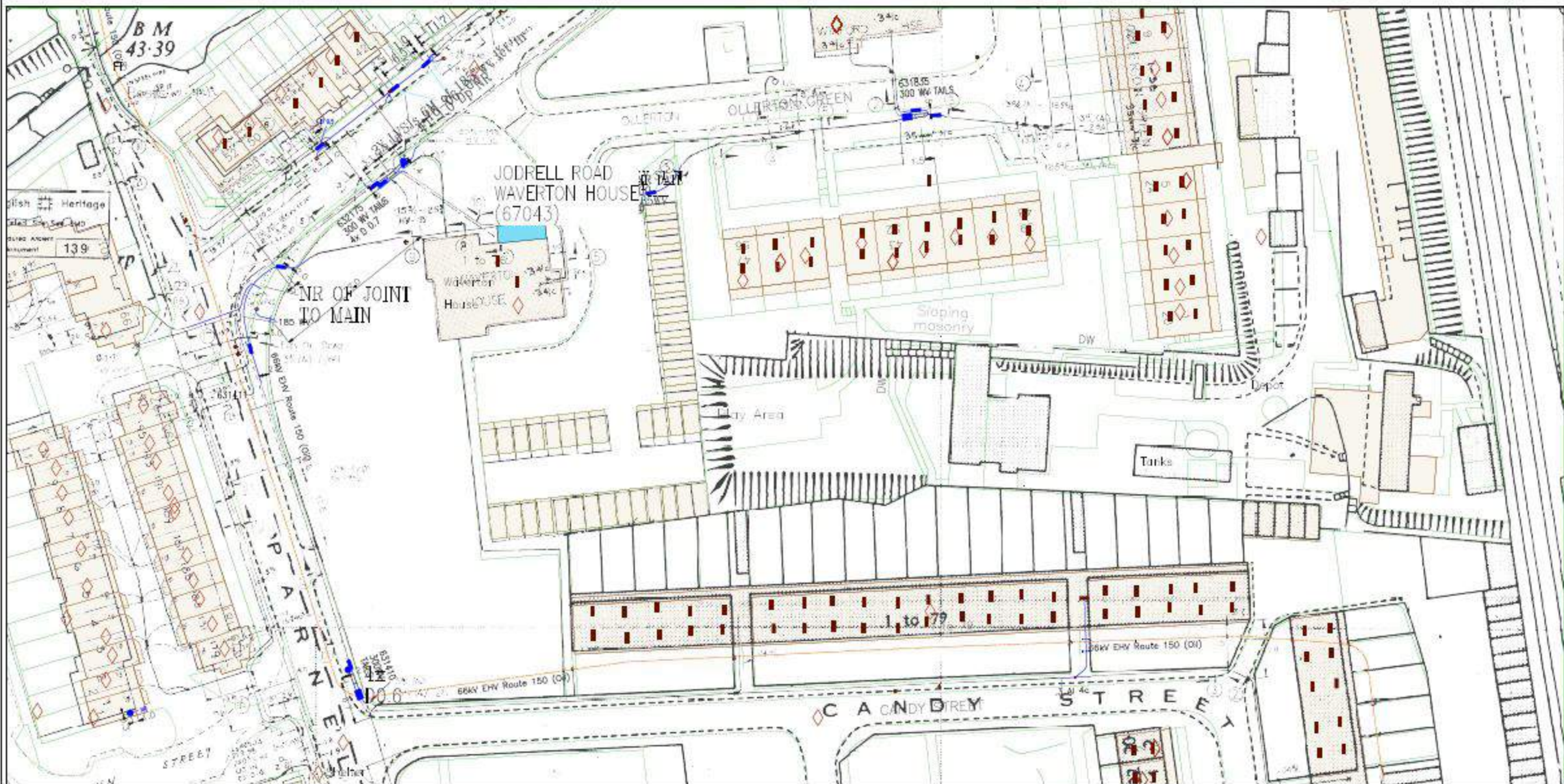

Printed On : 12/03/2015

File Description :

Map Centre : TQ5683NE



**PRIMARY CABLES**  
EXTRA HIGH VOLTAGE CABLES (EHV) 22,000 TO 132,000 Volts

Depth normally 750mm cover in carriageway & 600mm cover in footway.  
Before digging within one metre of these cable routes Telephone 0800 056 5866 in order that the Company's apparatus may be located at site and any necessary protection works agreed.

**N.B. THRUST BORES OR HOLES MUST NOT BE USED WITHIN THE VICINITY OF ANY CABLES BELONGING TO UK POWER NETWORKS WITHOUT FIRST CONTACTING THIS COMPANY.**

1. The position of the apparatus shown on this drawing is believed to be correct but the original landmarks may have been altered since the apparatus was installed.
2. The exact position of the apparatus should be verified - use approved cable avoidance tools prior to excavation using suitable hand tools.
3. It is essential that trial holes are carefully made avoiding the use of mechanical tools or picks and the exact location of all cables have been determined.
4. It must be assumed that there is a service cable over each property, lamp column and street light etc.
5. All cables must be treated as being live unless proved otherwise by UK Power Networks.
6. The information provided must be given to all people working near UK Power Networks plant & equipment. Do not use plants more than 3 months after the issue date for excavation.
7. **Caution:**
8. Please be aware that electric cables/buses belonging to other owners of licensed electricity distribution systems may be present and it is your responsibility to identify their location.

1. UK Power Networks Ltd does not warrant the information provided to you is correct. You rely upon it at your own risk.
2. UK Power Networks Ltd does not exclude or limit its liability if it causes the death of a person or causes personal injury to a person where such death or personal injury is caused by its negligence.
3. Subject to paragraph 2, UK Power Networks Ltd has no liability to you in contract, in tort (including negligence), for breach of statutory duty or otherwise howsoever for any loss, damage, costs, claims, demands or expenses that you or any third party may suffer or incur as a result of using the information provided whether for physical damage to property or for any economic loss (including without limitation loss of profit, loss of opportunity, loss of savings, loss of goodwill, loss of business, loss of use) or any special or consequential loss or damage whatsoever.

Reproduced by permission of Ordnance Survey on behalf of HMSO. (c) Crown copyright and database right 2015. All rights reserved. Ordnance Survey Licence number 100019626. Data has been added to the Ordnance Survey base map; all proprietary rights in such additional data are and shall remain the exclusive property of (c) Eastern Power Networks plc or London Power Networks plc each being a distribution licensee under section 5(1)(c) of the Electricity Act 1989 for the relevant distribution services area as that term is defined in such licensee's distribution licence. All rights in such data reserved.

**ADVICE TO CONTRACTORS ON AVOIDING DANGER FROM BURIED ELECTRICITY CABLES:**

- 1) Do have cable drawings with you on site and check them before you start the excavation.
- 2) Do have a cable locator tool on site and use it to help you.
- 3) Mark out the location of electricity cables.
- 4) Do not use a mechanical excavator within 0.5m of electricity cables.
- 5) Use spades and shovels in preference to other tools.
- 6) Never disturb electricity cables and joints or their protective covers.

**IF IN DOUBT - ASK PHONE 0800 056 5866  
EMERGENCY - If you damage a cable or line  
Phone 0800 760 0760 (24hrs) URGENTLY**

These basic safety precautions are explained in detail in the HSE booklet H52417 - Avoiding Danger from Underground Services, a copy of which may be obtained from your supervisor or HMSO.

Please be aware that electric lines belonging to other owners of licensed electricity distribution systems may be present and it is your responsibility to identify their location.



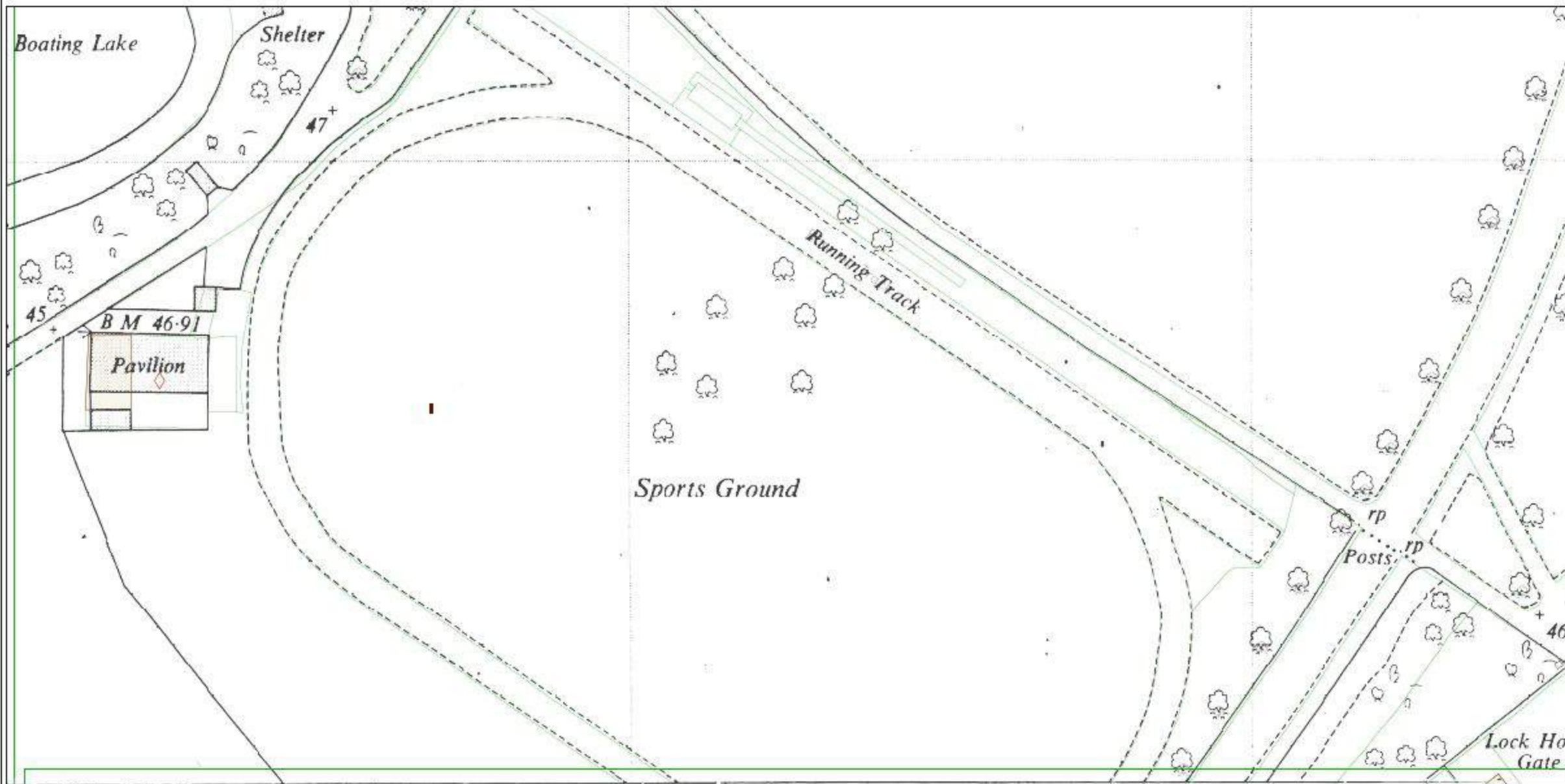

Filed On | 12/03/2015



Plot Description:

Map Centre : TQ35845E



**PRIMARY CABLES**  
**EXTRA HIGH VOLTAGE CABLES (EHV) 22,000 TO 132,000 Volts**  
 Depth normally 750mm cover in cartilageway & 600mm cover in footway.  
 Before digging within one metre of these cable routes Telephone 0800 035 5866 in order that the Company's apparatus may be located on site and any necessary protection works agreed.  
**N.B. THRUST BORERS OR HOLES MUST NOT BE USED WITHIN THE VICINITY OF ANY CABLES BELONGING TO UK POWER NETWORKS WITHOUT FIRST CONTACTING THIS COMPANY.**

1. The position of the apparatus shown on this drawing is believed to be correct but the original landmarks may have been altered since the apparatus was installed.
2. The cover position of the apparatus should be marked - use approved cable avoidance tools prior to excavation using suitable hand tools.
3. It is essential that trial holes are carefully made avoiding the use of mechanical tools or picks and the exact location of all cables have been identified.
4. It must be assumed that there is a service cable into each property, lamp column and street sign, etc.
5. All cables must be treated as being live unless proved otherwise by UK Power Networks.
6. The information provided must be given to all people working near UK Power Networks' plant & equipment. Do not use plans more than 3 months after the issue date for excavation.
7. **Caution:** Please be aware that electric cables/lines belonging to other owners of licensed electricity distribution systems may be present and it is your responsibility to identify their location.

1. UK Power Networks Ltd does not warrant that the information provided to you is correct. You rely upon it at your own risk.
2. UK Power Networks Ltd does not exclude or limit its liability in it causes the death of a person or causes personal injury to a person where such death or personal injury is caused by its negligence.
3. Subject to paragraph 2, UK Power Networks Ltd has no liability to you in contract, in tort (including negligence), for breach of statutory duty or otherwise howsoever for any loss, damage, costs, claims, demands or expenses that you or any third party may suffer or incur as a result of using the information provided whether for physical damage to property or for any economic loss (including without limitation loss of profit, loss of opportunity, loss of savings, loss of goodwill, loss of business, loss of use) or any special or consequential loss or damage whatsoever.

Reproduced by permission of Ordnance Survey on behalf of HMSO. (c) Crown copyright and database right 2015. All rights reserved. Ordnance Survey Licence number 100015626. Data has been added to the Ordnance Survey base map; all proprietary rights in such additional data are and shall remain the exclusive property of (c) Eastern Power Networks plc or London Power Networks plc each being a distribution licensee under section 5(1)(c) of the Electricity Act 1989 for the relevant distribution services area as that term is defined in such licensee's distribution licence. All rights in such data reserved.

**ADVICE TO CONTRACTORS ON AVOIDING DAMAGE FROM BURIED ELECTRICITY CABLES**

- 1) Do have cable drawings with you on site and check them before you start the excavation.
- 2) Do have a cable locator tool on site and use it to help you.
- 3) Mark out the location of electricity cables.
- 4) Do not use a mechanical excavator within 0.5m of electricity cables.
- 5) Use spades and shovels in preference to other tools.
- 6) Never disturb electricity cables and joints or their protective covers.

**IF IN DOUBT - ASK PHONE 0800 035 5866**  
**BID-ENTRY - If you damage a cable or line**  
 Phone 0800 750 0780 (24hrs) UK-BTL

These basic safety precautions are explained in detail in the RSE booklet H3(6)17 - Avoiding Danger from Underground Services, a copy of which may be obtained from your supervisor or HMSO.

Please be aware that electric lines belonging to other owners of licensed electricity distribution systems may be present and it is your responsibility to identify their location.

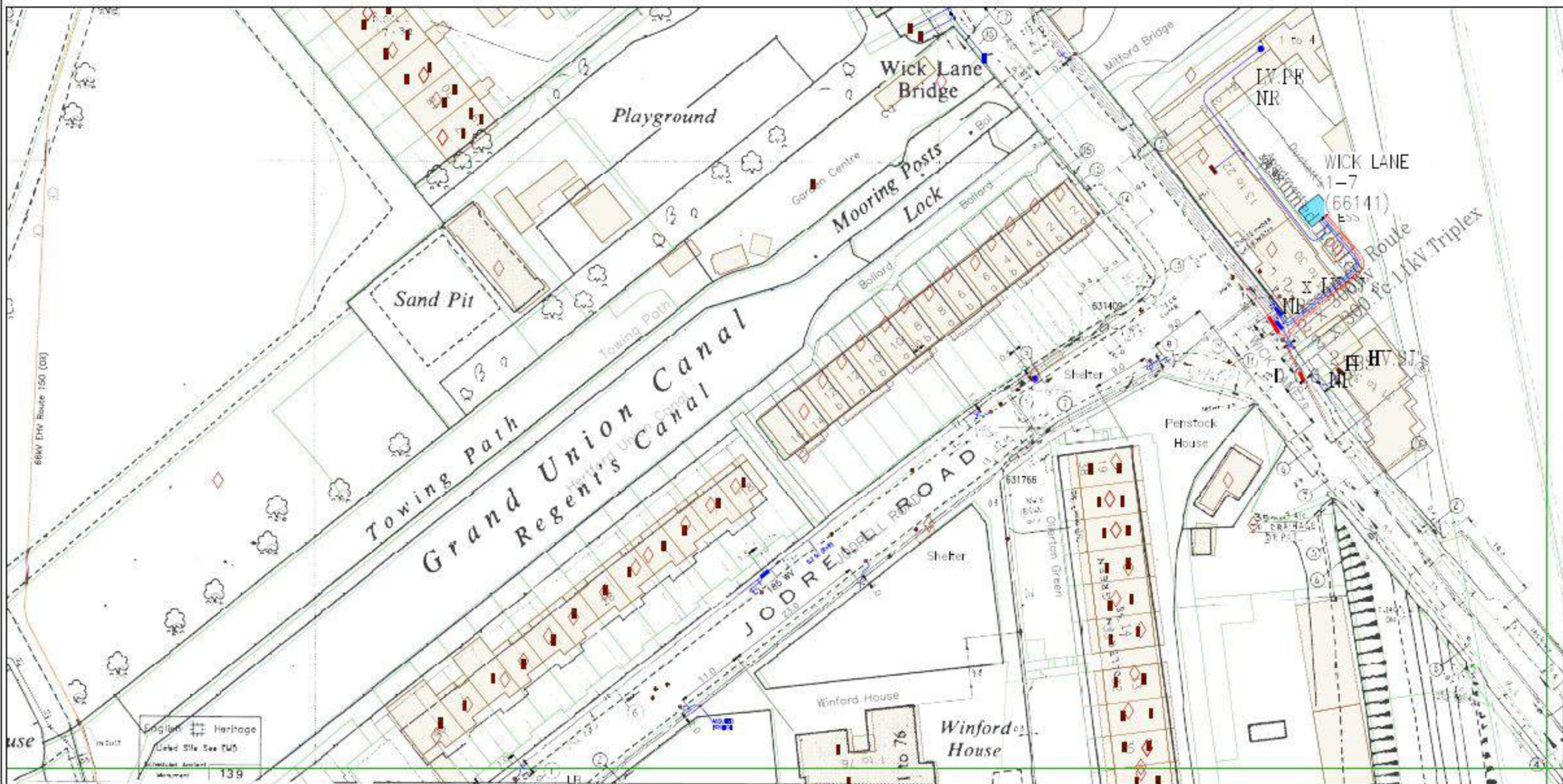

Filed On | 12/03/2015

File Description

Map Centre : T036843E



**PRIMARY CABLES**  
**EXTRA HIGH VOLTAGE CABLES (EHV) 22,000 TO 132,000 Volts**  
 Depth normally 750mm cover in carriageway & 600mm cover in footway.  
 Before digging within site limits of these cable routes  
 Telephone 0800 056 5956 in order that the Company's apparatus may be located  
 at site and any necessary protection works agreed.

**N.B. THURST BORERS OR MOLES MUST NOT BE USED WITHIN THE VICINITY OF ANY  
 CABLES BELONGING TO UK POWER NETWORKS WITHOUT FIRST CONTACTING THIS  
 COMPANY.**

1. The position of the apparatus shown on this drawing is believed to be correct but the  
 ground conditions may have been altered since the apparatus was installed.  
 2. The cover position of the apparatus should be marked - use approved cable avoidance mark  
 post to excavator using suitable hand tools.  
 3. It is essential that trial holes are carefully made avoiding the use of mechanical tools or  
 picks and the exact location of all cables have been determined.  
 4. It must be assumed that there is a service cable over each property, lamp column and street  
 sign.  
 5. All cables must be treated as being live unless proved otherwise by UK Power Networks.  
 6. The information provided must be given to all people working near UK Power Networks' plant  
 & equipment. Do not use plans more than 3 months after the issue date for excavation  
 work.  
 7. Please be aware that electric cables/lines belonging to other owners or licensed electricity  
 distribution systems may be present and it is your responsibility to identify their location.

1. UK Power Networks Ltd does not warrant that the information provided  
 to you is correct. You rely upon it at  
 your own risk.  
 2. UK Power Networks Ltd does not exclude or limit its liability if it causes  
 the death of a person or causes  
 personal injury to a person where such death or personal injury is  
 caused by its negligence.  
 3. Subject to paragraph 2, UK Power Networks Ltd has no liability to you  
 in contract, in tort (including negligence),  
 for breach of statutory duty or otherwise howsoever for any loss,  
 damage, costs, claims, demands or expenses that  
 you or any third party may suffer or incur as a result of using the  
 information provided whether for physical  
 damage to property or for any economic loss (including without  
 limitation loss of profits, loss of opportunity, loss of  
 savings, loss of goodwill, loss of business, loss of use) or any special  
 or consequential loss or damage whatsoever.

Reproduced by permission of Ordnance Survey on behalf of HMSO. (c)  
 Crown copyright and database right 2015. All rights reserved. Ordnance  
 Survey licence number 100019626. Data has been added to the Ordnance  
 Survey base map; all proprietary rights in such additional data are and  
 shall remain the exclusive property of (c) Eastern Power Networks plc or  
 London Power Networks plc each being a distributor licensee under  
 section 6(1)(c) of the Electricity Act 1989 for the relevant distributor  
 services area as that term is defined in such licensee's distribution  
 licence. All rights in such data reserved.

**ADVICE TO CONTRACTORS ON AVOIDING DANGER  
 FROM BURIED ELECTRICITY CABLES.**

- 1) Do have cable drawings with you on site and check them before you  
 start the excavation.
- 2) Do have a cable locator tool on site and use it to help you.
- 3) Mark out the location of electricity cables.
- 4) Do not use a mechanical excavator within 0.5m of electricity cables.
- 5) Use spades and shovels in preference to other tools.
- 6) Never disturb electricity cables and joints or their protective covers.

**IF IN DOUBT - ASK PHONE 0800 056 5966  
 BURENRY - If you damage a cable or line  
 Phone 0800 780 0760 (24hrs) UK ONLY**

These basic safety precautions are explained in detail in the HSE booklet  
 HS(R)47 - Avoiding Danger from Underground Services, a copy of which  
 may be obtained from your supervisor or HMSO.

Please be aware that electric lines belonging to other owners or licensed  
 electricity distribution systems may be present and it is your responsibility  
 to identify their location.

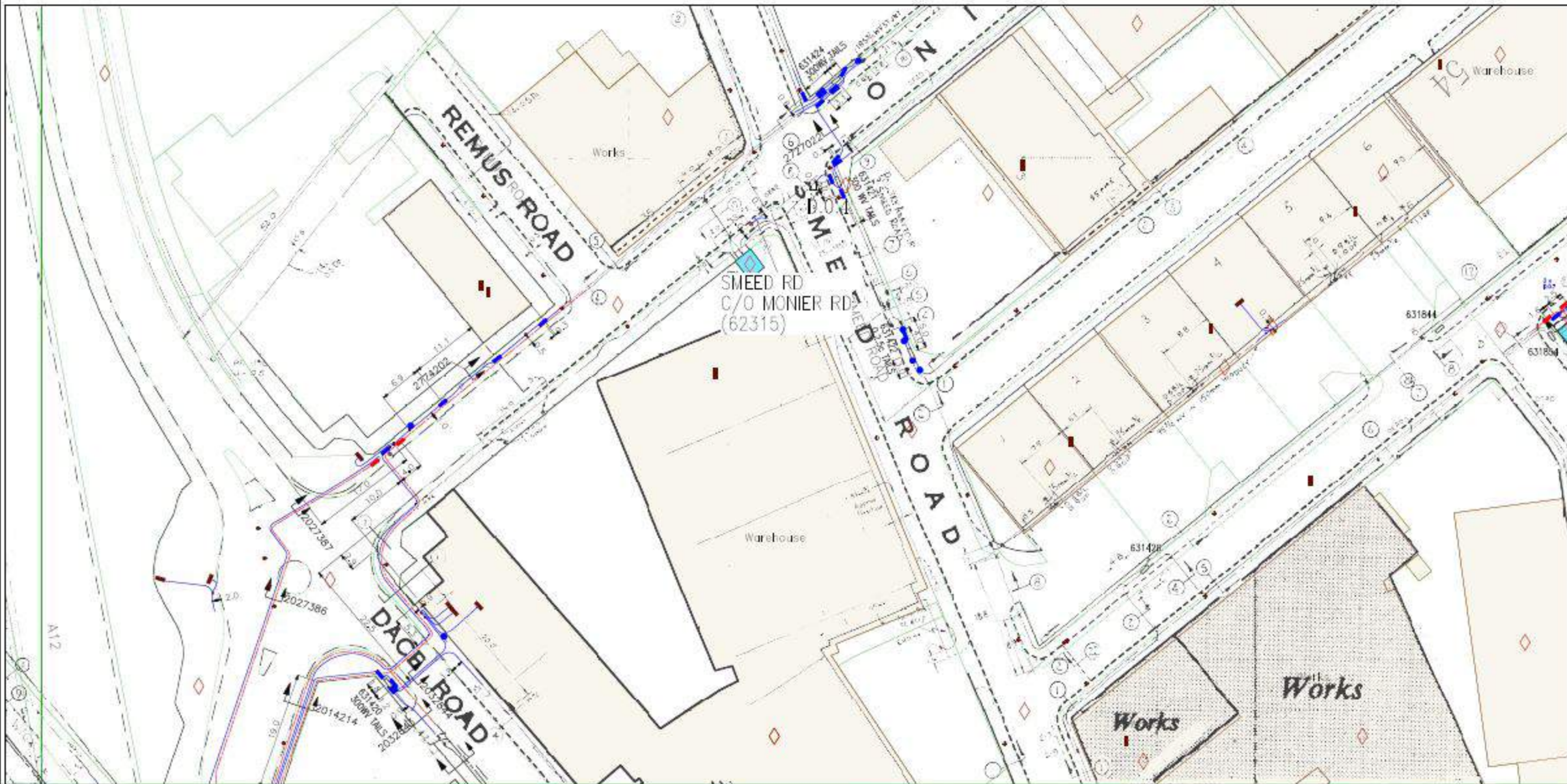

Printed On : 12/03/2015



File Description :

Map Centre : TQ57845W



For details of our cables please visit:  
<http://www.ukpower.co.uk/infocentre/infocentre.aspx?infocentre=underground>

**PRIMARY CABLES**  
**EXTRA HIGH VOLTAGE CABLES (EHV) 22,000 TO 132,000 Volts**

Depth normally 750mm cover in carriageway & 600mm cover in footway.  
 Before digging within one metre of these cable routes  
 Telephone 0800 056 5856 in order that the Company's apparatus may be located  
 at site and any necessary protection works agreed.

**N.B. TRUST BORDERS OR HOLES MUST NOT BE USED WITHIN THE VICINITY OF ANY  
 CABLES BELONGING TO UK POWER NETWORKS WITHOUT FIRST CONTACTING THIS  
 COMPANY.**

1. The position of the apparatus shown on this drawing is believed to be correct but the original handbooks may have been altered since the apparatus was installed.
2. The exact position of the apparatus should be verified - use approved cable avoidance tools prior to excavation using suitable hand tools.
3. It is essential that trial holes are carefully made avoiding the use of mechanical tools or picks and the exact location of all cables have been determined.
4. It must be assumed that there is a service cable into each property, lamp column and street furniture etc.
5. All cables must be treated as being live unless proved otherwise by UK Power Networks.
6. The information provided must be given to all people working near UK Power Networks' plant & equipment. Do not use plants more than 3 months after the issue date for excavation.
7. **Caution:**
8. Please be aware that electric cables/buses belonging to other owners of licensed electricity distribution systems may be present and it is your responsibility to identify their location.

1. UK Power Networks Ltd does not warrant or give information provided to you is correct. You rely upon it at your own risk.
2. UK Power Networks Ltd does not exclude or limit its liability if it causes the death of a person or causes personal injury to a person where such death or personal injury is caused by its negligence.
3. Subject to paragraph 2, UK Power Networks Ltd has no liability to you in contract, in tort (including negligence), for breach of statutory duty or otherwise howsoever for any loss, damage, costs, claims, demands or expenses that you or any third party may suffer or incur as a result of using the information provided whether for physical damage to property or for any economic loss (including without limitation loss of profits, loss of opportunity, loss of savings, loss of goodwill, loss of business, loss of use) or any special or consequential loss or damage whatsoever.

Reproduced by permission of Ordnance Survey on behalf of HMSO. (c) Crown copyright and database right 2015. All rights reserved. Ordnance Survey Licence number 100015626. Data has been added to the Ordnance Survey base map; all proprietary rights in such additional data are and shall remain the exclusive property of (c) Eastern Power Networks plc or London Power Networks plc each being a distribution licensee under section 6(1)(c) of the Electricity Act 1989 for the relevant distribution services area as that term is defined in such licensee's distribution licence. All rights in such data reserved.

**ADVICE TO CONTRACTORS ON AVOIDING DANGER FROM BURIED ELECTRICITY CABLES**

- 1) Do have cable drawings with you on site and check them before you start the excavation.
- 2) Do have a cable locator tool on site and use it to help you.
- 3) Mark out the location of electricity cables.
- 4) Do not use a mechanical excavator within 0.5m of electricity cables.
- 5) Use spades and shovels in preference to other tools.
- 6) Never disturb electricity cables and joints or their protective covers.

**IF IN DOUBT - ASK! PHONE 0800 056 5866  
 BURENRY - If you damage a cable or line  
 Phone 0800 780 0780 (24hrs) UK-BNLY**

These basic safety precautions are explained in detail in the HSE booklet H5(4)17 - Avoiding Danger from Underground Services, a copy of which may be obtained from your supervisor or HMSO.

Please be aware that electric lines belonging to other owners of licensed electricity distribution systems may be present and it is your responsibility to identify their location.



# Network Records NetMAP Symbols Booklet - London

This symbol booklet is intended as a general guide only - some local variations of these symbols may be found.

**Version 1.2**  
Released October 2010

## Index:-

Page no:	Contents:
1	Guidance notes.
2	The area covered by this guide.
3	Scenery.
4	Scenery (UK Power Networks use only-boxed red)
7	Primary distribution cables (EHV).
8	Secondary distribution cables (LV/HV).
9	Cable terminology.
10	Cable size abbreviations.
11	Cable ducts.
12	Other NetMAP symbols.
15	Services.
17	Symbols used in cross sections.
19	Abbreviations used in cross sections.
20	Typical plan and cross section representations: <ul style="list-style-type: none"><li>All areas: NetMAP/vector.</li><li>All areas: composite raster style 1.</li><li>Ex-Western area and Holborn: main and ways.</li><li>The City of London: single line.</li><li>Finsbury and Shoreditch: multi-single line style 1.</li><li>Ex-North Eastern area: HV/LV.</li><li>Ex-North Eastern area: multi-single line style 2.</li><li>Ex-North Eastern area: composite raster style 2.</li></ul>
23	Regional NetMAP anomalies - general overview.
24	Region 1: ex-Western area.
25	Region 2: ex-Northern area.
27	Region 3: ex-North eastern area.
29	Region 4: ex-South Eastern area.
30	Region 5: ex Southern area.

## Guidance notes.







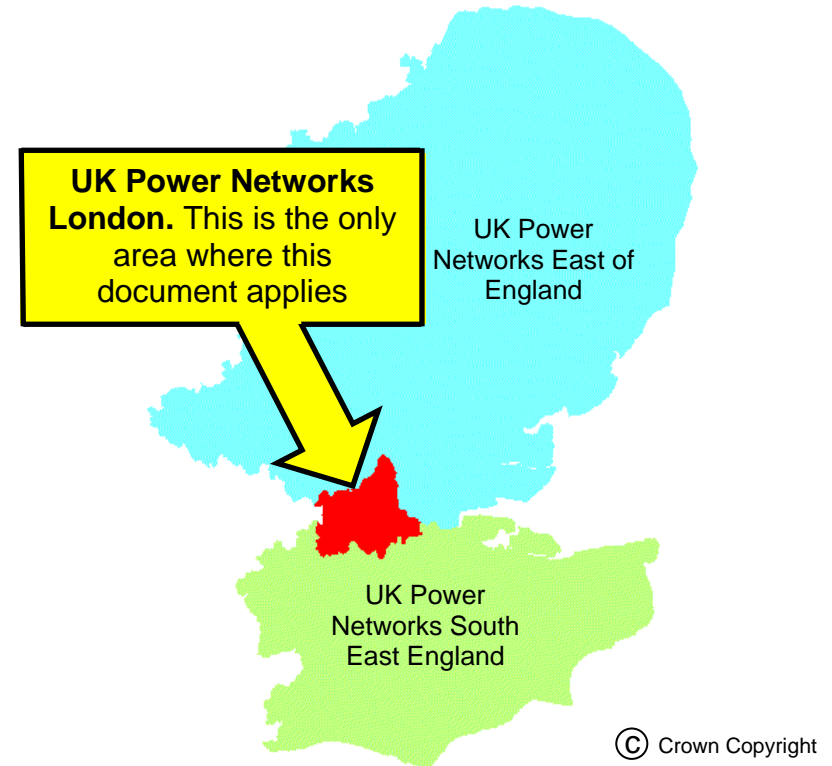







- The position of apparatus shown on NetMAP is believed to be correct, but the original landmarks may have altered since the apparatus was installed.
- It must be assumed that there is at least one service to each property, lamp column, street sign etc. A separate record may be available.
- When excavations are to be carried out near Extra High Voltage (EHV) cables, further details must be obtained before commencement of work.
- Third party cables are not usually shown.
- When two or more maps are supplied for the same area, the maps must be read in conjunction with each other and with this symbol booklet.
- All LV cables are assumed to be 4 core, and all HV cables assumed to be 3 core – unless otherwise stated.
- All Imperial cable sizes are assumed to be copper and all metric cable sizes are assumed to be aluminium – unless otherwise stated.







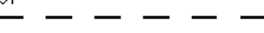

## The area covered by this guide:









Please see the anomalies map at the end of this safety booklet for greater map area detail, and a breakdown of the more significant anomalies within the London area.

Scenery		
NetMAP system	Scanned image	Description
		100 metre Ordnance Survey grid line (on O/S based maps only)
		Property fence line
		Building line
		Kerb line
		Kerb line on majority of ways & mains maps
		Cable tunnel or subway
NOT APPLICABLE		Borough or City boundary and UK Power Networks boundary
		
		UK Power Networks or Electrical boundary
		

Scenery for UK Power Networks use only - boxed in red		
NetMAP system	Scanned image	Description
 Inset Network – Contact xxxx IDNO for further information	Not applicable	Area of inset network - not the asset of UK Power Networks (only visible to UK Power Networks and their immediate contractors)
	Not applicable	Proposed Cross Rail route (only visible to of UK Power Networks and their immediate contractors)
	Not applicable	High pressure pipelines in the general vicinity (only visible to of UK Power Networks and their immediate contractors)
<p>Note: Pipelines are only viewable on NetMAP by UK Power Networks staff and their immediate contractors. Do not carry out any excavation without consent from the relevant agency - legally protected high pressure petroleum products pipeline route in the general vicinity - consult <a href="http://www.linewatch.co.uk">www.linewatch.co.uk</a> for contacts and guidance. Pipeline contact numbers can also be found on the intranet – out of hours, contact our Control Centre.</p>		
	Not applicable	Water - surface water (only visible to UK Power Networks and their immediate contractors)
	Not applicable	Water - Source Protection Zone 1 (only visible to UK Power Networks and their immediate contractors)
	Not applicable	Water - Source Protection Zone 2 (only visible to UK Power Networks and their immediate contractors)
	Not applicable	Water - Source Protection Zone 3 (only visible to UK Power Networks and their immediate contractors)









section continued on next page

**Scenery for UK Power Networks use only - boxed in red**







NetMAP system	Scanned image	Description
	Not applicable	Historical - Scheduled Monuments (only visible to UK Power Networks and their immediate contractors)
	Not applicable	Historical - Parks and Gardens (only visible to UK Power Networks and their immediate contractors)
	Not applicable	Historical - Areas of Archaeological Potential (AAP) (only visible to UK Power Networks and their immediate contractors)
	Not applicable	Nature - Ramsar Wetlands of International Importance (only visible to UK Power Networks and their immediate contractors)
	Not applicable	Nature - Special Area of Conservation (SAC) (only visible to UK Power Networks and their immediate contractors)
	Not applicable	Nature - Special Protected Area (SPA) (only visible UK Power Networks and their immediate contractors)
	Not applicable	Nature - Site of Special and Scientific Interest (SSSI) (only visible to UK Power Networks and their immediate contractors)

**section continued on next page**





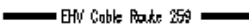

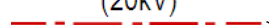
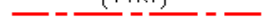

**Scenery for UK Power Networks use only - boxed in red**

NetMAP system	Scanned image	Description
	Not applicable	Nature - Local Nature Reserve (only visible to UK Power Networks and their immediate contractors)
	Not applicable	Nature - National Nature Reserve (only visible to UK Power Networks and their immediate contractors)
	Not applicable	Nature - Area of Outstanding Natural Beauty (AONB) (only visible to UK Power Networks and their immediate contractors)
	Not applicable	Nature - National Park (only visible to UK Power Networks and their immediate contractors)
	Not applicable	Fluid filled cables - very high sensitivity (only visible to UK Power Networks and their immediate contractors)
	Not applicable	Fluid filled cables - high sensitivity (only visible to UK Power Networks and their immediate contractors)
	Not applicable	Fluid filled cables - medium sensitivity (only visible to UK Power Networks and their immediate contractors)
	Not applicable	Fluid filled cables - low sensitivity (only visible to UK Power Networks and their immediate contractors)

## Primary distribution cables

NetMAP system	Scanned image	Description
 Solid  Gas  Oil  Cable stop  Shallow	 EHV Cable Route 259  Not applicable  	UK Power Networks route (11,000 , 22,000 to 132,000 volts)  Oil/gas cable stop  Part of UK Power Networks cable route where cover is less than normal

## Secondary distribution cables

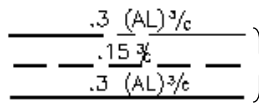
NetMAP system	Scanned image	Description
(20kV)  (11kV)  (6.6kV)          	 $.3 (AL)\%e$ $.15\%$ $.3 (AL)\%e$  $185\%e$  $.0225\%e$  Not applicable  Not applicable  Not applicable  Not applicable	HV cable (up to 20kV)    3 phase LV cable (230V or 400/230V) 1 or 2 phase LV cable (230V or 400/230V)  Pilot or Telephone cable, often not shown in plan if running with other cables Fibre-optic cable Earth cable  HV or LV cable in duct  Duct route(s) not containing live cables



Cable terminology		
NetMAP system	Scanned image	Description
PL	PL	Paper Lead
PLS	PLS	Paper Lead Served
PLST or PLSW	PLA	Paper Lead Armoured
PLSTS	PLTS	Paper Lead Steel Tape Served
PLSTS	PLDT	Paper Lead Double Tape
PLSWS	PLWS	Paper Lead Steel Wire Served
PLSW	PLBW	Paper Lead Bright Wire
PLS	LC & H	Lead Covered & Hessian
PLST or PLSW	LC & A	Lead Covered & Armoured
PLSW	LC & BA	Lead Covered & Bright Armoured
PLST	DSTA	Double steel tape armoured
PLST	STA	Steel Tape Armoured
PLSW	SWA	Steel Wire Armoured
Al	Al	Aluminium
Cu	Cu	Copper
WV	WV	Waveconal
CS	CS	Cansac
PVC	PVC	Polyvinyl Chloride
EPR	EPR	Ethylene Propylene Rubber
XLPE	XLPE	Cross Linked Polyethylene
SOL	SOLIDAL	Solid Aluminium
ax	TRIPLEX	Triplex (aluminium)
cx	TRIPLEX	Triplex (copper)

Cable size abbreviations		
NetMAP system	Scanned image	Description
1c	$\frac{1}{c}$	Single core.
c/c	$\frac{c}{c}$	Concentric cores
t/c	$\frac{T}{c}$ or $T/cc$	Triple concentric cores
4c	$\frac{4}{c}$	Four cores
3c CNE	$\frac{3}{c}$ (CNE)	Three cores and concentric neutral – not of the Waveconal type
2c	$\frac{2}{c}$ (or Tw)	Two cores (or twin)
s/c	$\frac{s}{c}$	Split concentric cores
3c	$\frac{3}{c}$	Three cores
DC	DC	Direct current
P	P	Pilot
Pr	Pr	Number of telephone pairs

Cable ducts		
NetMAP system	Scanned image	Description
		Single empty ducts
		Cluster of empty ducts (two or more)
		Cable in single duct
		Group of cables shown in a cluster of ducts, plus one or more empty (shown in section)
		Ex-Western area 'ways' maps: This symbol indicates one or more ducts.
		On City of London area maps "extent of ducts" symbols are not in general use as most duct runs are between pits or boxes

Other NetMAP symbols		
NetMAP system	Scanned image	Description
<u>0.3 4c AL PLSWS</u> (Details also in cable attributes and/or section)		Cable size (and year laid)
		Cable capped end
		Cable pressure (or pot) end or signal end
		Pressure/pot end & earth cable/electrode
		Earth rod (vertical)
		Earth rod (horizontal)
		Earth plate
		Earth plate or end
		Bottle or trouser joint or combined crutch & pressure end - (CPE)
		Straight joints
		Tee joints
		Crutch (or spur) joints (CJ) straight & crutch joints combined (S&CJ)
		Double crutch (or spur) joint
		Sleeve
		UT (Disconnected universal tee)

section continued on next page

### Other NetMAP symbols





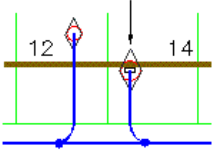
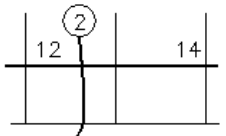

NetMAP system	Scanned image	Description
		Four way underground disconnecting boxes(DB)
		Link boxes(LB)
		Network boxes(NB) or (NWB)
		4 way 6 entry
		6 way box
		6 way 8 entry
		Split bus-bar
		Link box with identification number
		3 way underground disconnecting boxes
		2 way underground disconnecting boxes
		1 way underground disconnecting boxes
		Feeder pillars
		Split bus-bar distribution pillar
		Double bus-bar distribution pillar
		Blind pit/pit
		Pit with access

section continued on next page



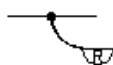
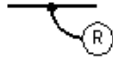

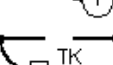
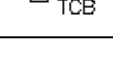













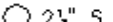







### Other NetMAP symbols

NetMAP system	Scanned image	Description
		Transformer chambers (T/C) & transformer compounds
		Underground transformer chamber
	Not applicable	Missing data in or near this location
		Underground tank
		Indicates service between separate buildings is looped
		Jointing schedule numbers or phasing diagram
	Not applicable	Contaminated land reference
		Instrument traced cable or ITC - cable traced electronically using Cable Avoidance Tool (CAT) or similar

Services		
NetMAP system	Scanned image	Description
SRC = Service Record Card		
To a property/metered supply (also see SRC)		
<p>Address point ◇</p> <p>Supply point ○</p> <p>Also see SRC and joint/cable attributes</p> <p>Service in external cabinet</p>  <p>Also see SRC and joint/cable attributes</p>	<p>Also see SRC</p> <ul style="list-style-type: none"> <li>Ⓜ Single phase service</li> <li>① Connected to 1 core &amp; neutral</li> <li>Ⓡ Connected to red core &amp; neutral</li> <li>⊕ Three phase service</li> <li>⊕ Connected to inner &amp; outer cores of triple conc cable</li> <li>⊖ Connected to middle &amp; outer cores of triple conc cable</li> <li>⊕ Connected to all three cores of triple conc cable</li> </ul>  <p>ROYAL MEWS</p>	<p>Existence of a service with its core connection shown in circle</p>
<b>section continued on next page</b>		









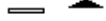

Services		
NetMAP system	Scanned image	Description
To street furniture/un-metered supply (also see SRC)		
<p>Please note that newly edited street furniture no longer has an address point or an SRC</p>  <p>(Street furniture general)</p>  <p>(Street furniture feeder pillar or cabinet)</p>	 <p>P.L.S.261 LC</p>  <p>S.L.261</p>  <p>WB</p>  <p>TL</p>  <p>FB</p>  <p>TS</p>  <p>B IGP</p>  <p>TK,TC TKB FP</p>	<p>Public lighting</p> <p>Street lighting</p> <p>Wall bracket</p> <p>Traffic light control</p> <p>Flashing beacon</p> <p>Traffic sign</p> <p>Bollard/illuminated guard post</p> <p>Telephone kiosk, traffic controller, feeder pillar</p>

### Symbols used in cross sections

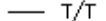
NetMAP system	Scanned image	Description
		Cable laid direct
		Cable laid in duct
		Blocked duct (sometimes used for unidentified cables)
		Single earthenware duct
		Single steel pipe
		Square cable duct
		Group of circular ducts
		Group of circular ducts (Sykes)
		Group of square ducts (Doulton)
		Cable trough
		Bitumen casing (Crompton)
		Bitumen filled iron trough (Trunks)
		Bitumen casing (Tri-case)

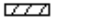
section continued on next page

### Symbols used in cross sections

NetMAP system	Scanned image	Description
		Protective slab
		Tiles.
		Concrete slabs
		Steel plate
		Plastic tile tape
Timber 		Timber

## Abbreviations used in cross sections

NetMAP system	Scanned image	Description
EW	E.W.D(s) or EW.	Earthenware ducts
F	F.P or F or F.D	Fibre duct
A	ASB or A	Asbestos
P	P	Plastic or pitch fibre
S	S.P or S	Steel
C	C.I or C or C.I.P	Cast iron
WI	W.I	Wrought iron pipe
F	F or F.D	Fibre duct
PRD	PRD	Plastic Rigiduct
Left blank – means NR	{ D.N.K or D:NR N.R or (N.R)	Depth not known No record
E.V	E.V.P or E.V	Everite pipe
T/T	T/T	Tape Tile
N/A	3/62 or NOV 79	Date cable laid
N/A—destination now only shown in cable attribute	ABCD etc	HV cable destination (See section sheet HV ref)
	Please note: Ducts are assumed to be 4"/100mm earthenware – unless otherwise stated	

## Typical plan and cross section representations

### Multi-line composite NetMAP/vector representation

All areas – drawn/redrawn using NetMAP GIS

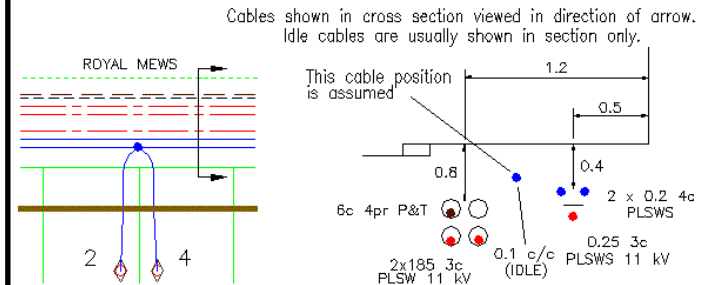

Applies to all composite vector records in both shaded and unshaded areas of the anomalies map.

### Multi-line representation - general composite raster (style 1)

All areas

All cables are shown on plan and represented in section.  
Sections may be shown in plan view or on a supplementary sheet.

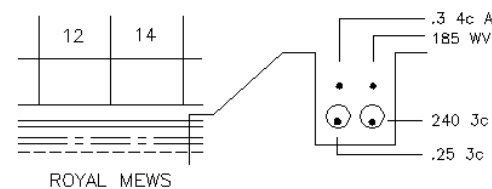

Applies to all composite raster records within the unshaded areas of the anomalies map.  
Can also be found in some shaded areas – in particular the ex-North Eastern shaded areas 3 (b) and 3 (c)

### Main and ways representation – dual layer raster

Ex Western area Holborn and parts of Ex-South Eastern Area only

All cables are shown on plan and represented in cross section on a separate (ways) sheet.

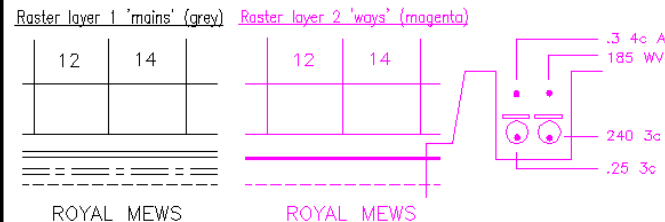

Applies to area 1(a) of the anomalies map.



Applies to area 2(a) of the anomalies map.



## Typical plan and cross section representations

### Single line representation - raster or vector data

The City of London only

All cables are shown as a single line in plan.  
Sections may be written and not drawn.

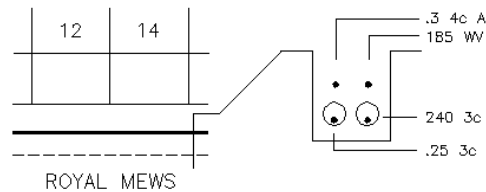

OR this style may be used.

1-3 way Tricase  
2-2½" steel pipes  
1-6 way Doulton  
.4% (L.V. cable)

Applies to area 2(b)  
on the anomalies map.

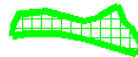

### Multi-single line representation general (style 1)

Finsbury and Shoreditch only

Only the top cables in a vertical cable run are shown in the plan view. See the example below.  
Note that the two lower cables that are in ducts (in this instance), are not shown in plan.  
Therefore cross sections are particularly important, as each line represents one or more cables.

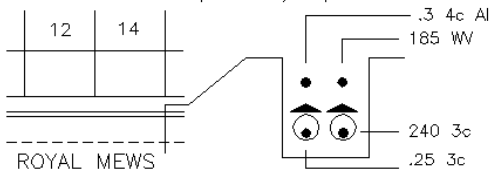

Applies to area 2 (c)  
of the anomalies map.



### HV and LV map representation – dual layer raster

Ex-North Eastern area only

HV and LV cables are shown on separate raster layers. These layers MUST be read in conjunction with each other. Sections are shown on a combined supplementary section sheet in numerical sequence.

Raster layer 1 HV (red) Raster layer 2 LV (blue) Separate raster section sheet

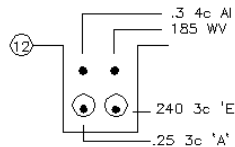
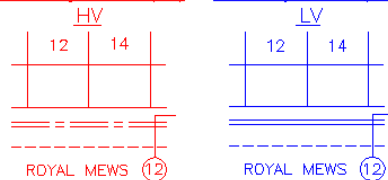

Applies to area 3(a)  
of the anomalies map.



## Typical plan and cross section representations

### Multi-single line representation general (style 2)

Ex-North Eastern area only

In this area each voltage (HV and LV) is represented as an individual line. For example, three HV cables and four LV cables in the same run will be indicated by a single HV line and a single LV line. Therefore cross sections are particularly important, as each line represents one or more cables of that voltage.

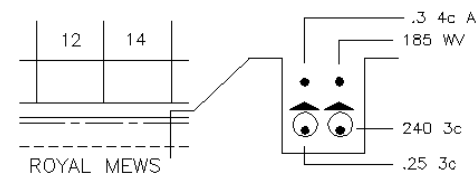

Applies to area 3 (b)  
of the anomalies map.



### Multi-line representation - composite raster (style 2)

Ex North Eastern area only

All cables are individually shown in plan.  
Sections are shown on a supplementary section sheet and recorded under the relevant road name.

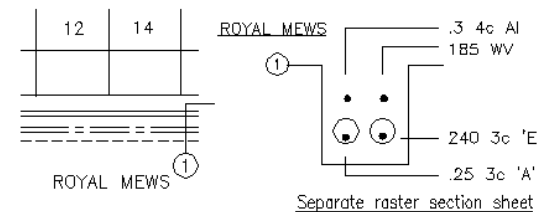

Applies to area 3(c)  
of the anomalies map.



### Important note regarding sections:

It does not follow that if the number of cables shown in the cross section have been located, that all live cables have been found. You may have found an unrecorded cable, or a cable belonging to another authority.

## Regional NetMAP Anomalies - general overview:

The following pages explain the various major map style anomalies found within the London area. These styles are a legacy from the five individual London Electricity areas which were again formed from seventeen separately organised LEB districts. Areas with significant anomalies are shown in the following pages as cross-hatched areas. Areas with standard composite vector and raster layer information are shown as un-hatched areas.

**Cautionary note:** - any region or sub-region, either shaded or un-shaded, may contain some local anomalies not mentioned in the following pages – if in doubt, please contact the UK Power Networks Plan Provision team on telephone number 08701 963797.

**All regions (1-5) will contain recently created composite vector (NetMAP/AutoCAD) data.**

Recent work created using the NetMAP system and previously created using the AutoCAD system (as opposed to raster/scanned data) are recorded in the composite vector style shown on the UK Power Networks London area symbol sheet - see the first example on page 18 of this document. Recent data will be indicated by the existence of multi-coloured cables on the NetMAP system, but this may not be reflected on printed matter produced with a black and white printer. AutoCAD data looks similar to the coloured NetMAP data, but does not hold any cable 'attributes' when selected using the NetMAP system. These cables will be represented individually (multi-line representation). New NetMAP cross sections may be accessed electronically on the NetMAP system and are presented in printed format accompanied by a seven digit NetMAP identification number.

### Overview map:-

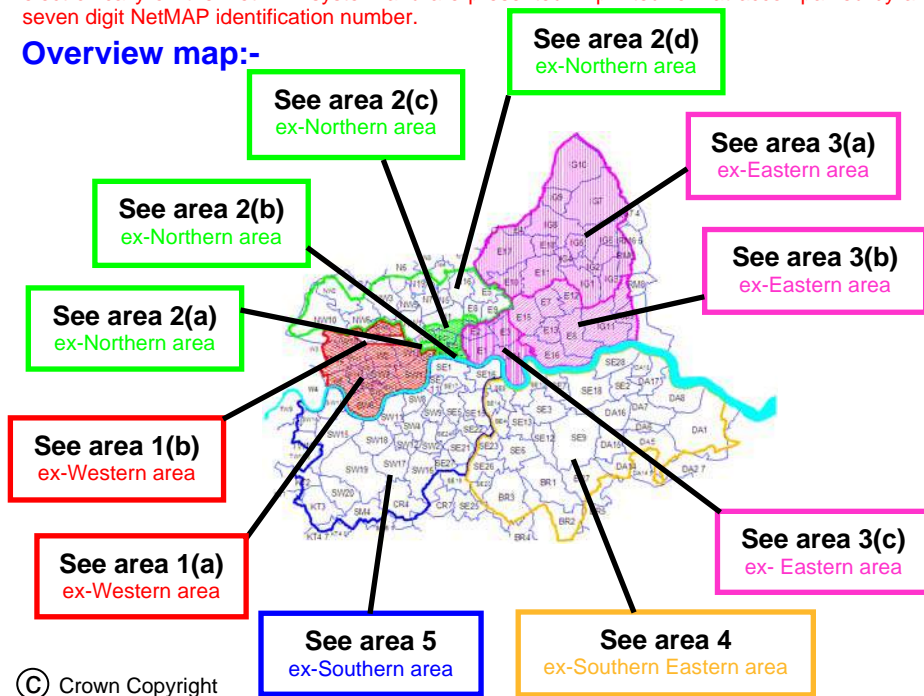

See following pages for further details.

## Region 1 ex-Western area

This region includes Westminster, Kensington, Chelsea, Hammersmith and Fulham. The region is covered by two map layer systems – **region 1(a)** mains and ways dual layer raster, and **region 1(b)** composite raster. The following explains this in greater detail.

**Region 1(a)** (hatched )

**Mains and ways representation:**

This system consists of two maps layers for the same area.

- The mains map shows all cable routes.
- The ways map shows pipe and duct routes with cross sections.

There are some enlargement sheets, cross sections and jointing details. EHV routes are shown on either the mains or the ways map.

**It is important that all these maps are read in conjunction with each other.**

**Caution:** - It is also important to note that the kerb line detail on these maps is a dash/dot line, which on the majority of UK Power Networks Central (London) records would refer to an HV cable route. HV cables are shown as a solid line when laid direct and a dashed line when in a duct.

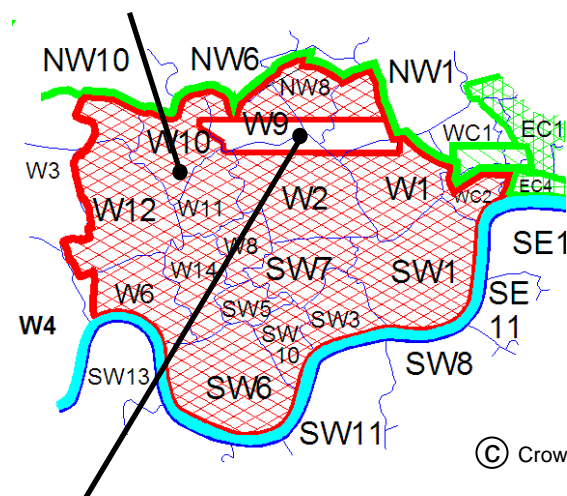

© Crown Copyright

**Region 1(b)** (un-hatched )

**Composite single layer (style 1) maps:**

Whenever possible, all the information is on one map layer. There are some enlargement sheets in the Aberdeen Place area. Please note that the kerb line is shown as a dotted line and HV cables are shown as dash/dot lines.



## Region 2 ex-Northern area

This region includes Islington, Hackney, the City of London and parts of Brent, Camden and Ealing. The region is covered by four map layer systems - **Region 2(a)** - mains and ways dual layer raster (Holborn area), **Region 2(b)** - single line representation (City of London), **Region 2(c)** - multi-single line representation (Finsbury and Shoreditch) and **Region 2(d)** - composite multi-line maps (all other areas). This following explains this in greater detail.

### Region 2(a) (hatched )

Covers part of WC1 and WC2 (Holborn).

#### Mains and ways representation:

This system consists of two maps layers for the same area.

- i) The mains map shows all cable routes.
- ii) The ways map shows pipe and duct routes with cross sections.

Where needed, extra sheets have been added for enlargements, cross sections and jointing details. EHV routes are shown on the mains map layer.

**It is important that all these maps are read in conjunction with each other.**

**Caution:** - It is also important to note that the kerb line detail on these maps is a dash/dot line, which on the majority of UK Power Networks Central (London) records would refer to an HV cable route. HV cables are shown as a solid line when laid direct and a dashed line when in a duct.



© Crown Copyright

### Region 2(b) (hatched )

Covers parts of postal areas EC1, EC2 and all of postal areas EC3 and EC4.

#### Single line representation maps:

Whenever possible, all the information is on one map layer. One line can represent any number of cables or ducts. It is therefore very important to use cross sections. In some cross sections details may be written and not drawn. In complex and redrawn areas, some detail may be drawn using multi-line representation. There are some enlargement sheets.

### Region 2(c) (hatched )

Covers parts of postal areas EC1, EC2, N1, E1, E2 and E8.

#### Multi-single line representation (style 1) maps:

Whenever possible, all the information is on one map layer. When cables lay immediately above/below each other, it is shown as a single line. For example if six cables lay three on three, only three lines would indicate the six cables. If the cables were laid flat, six separate lines would be shown. It is therefore important not to assume that the lines drawn indicate the number of cables, at any point. **Cross sections must be used.**

© Crown Copyright

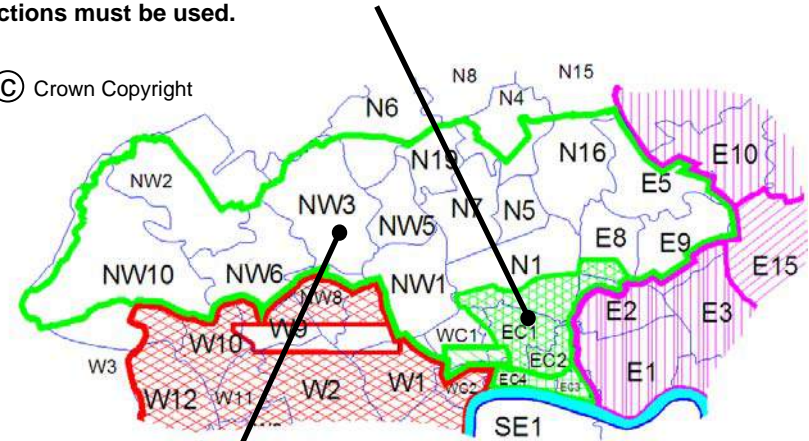

### Region 2(d) (un-hatched)

Covers all other postal areas in this region

#### Composite single layer (style 1) maps:

Whenever possible, all the information is on one map layer. There are some enlargement sheets.

## Region 3 ex-North Eastern area

This region includes Tower Hamlets, Newham, Redbridge, Waltham Forest, Loughton (Epping) and Barking and Dagenham. This region is covered by three mapping systems.

### Region 3(a) (hatched )

#### Separate HV and LV representation maps:

This system consists of two maps layers for the same area.

- i) The HV map layer showing HV cables and duct routes.
- ii) The LV map layer showing LV cables and duct routes.

Cross sections for both HV and LV cable routes are shown on a separate sheet. EHV cable routes are shown on the HV map layer.

**It is important that all these maps are read in conjunction with each other.**

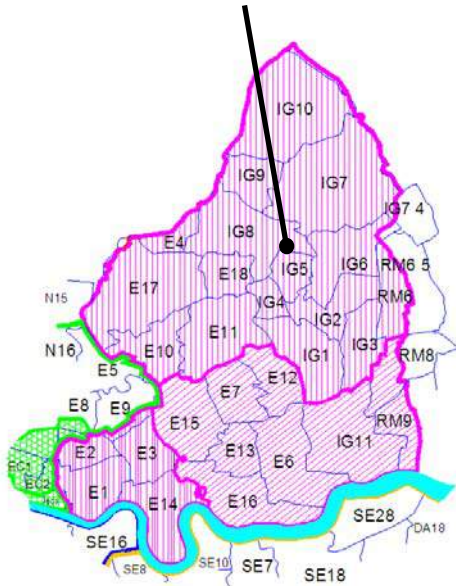

© Crown Copyright

### Region 3(b) (hatched )

#### A combination of composite single layer (style 1) and multi-single line (style 2):

Whenever possible, all the information is on one map layer. There are some enlargement sheets. There is a combination of map styles used in this area. Some areas may be conventional multi-line line representation with many areas of multi-single line representation. In the multi-line areas each (live) cable is shown individually in plan. In the multi-single line map areas, there is a single line for each voltage type, with a single HV line and a single LV line representing more than one cable run of each voltage (when applicable). Therefore a cable run containing three HV cable and four LV cables will be represented by one HV line and one LV line.

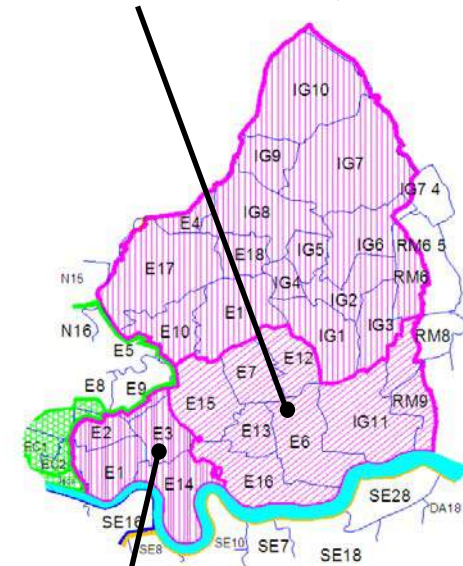

© Crown Copyright

### Region 3(c) (hatched )

#### A combination of composite single layer (style 2) and multi-single line (style 2):

Whenever possible, all the information is on one map layer. There are some enlargement sheets. In this area (postal code areas E1, E2, E3, E14 and part of E9), the cross sections are listed under each road name. It is therefore extremely important that you have the correct cross sections for the road you are working in.

There is a combination of map styles used in this area. Most areas are composite single layer (style 2) with some areas of multi-single line representation, as described in region 3(b).

## Region 4 ex-South Eastern area

This region includes Lewisham, Greenwich, Bromley, Bexley and Dartford.  
Nearly all maps are drawn in one style – single layer composite raster/vector.

### Region 4 (un-hatched)

#### Composite single layer (style 1) with a small number of mains and ways representation maps :

Mainly composite maps - whenever possible, all the information is on one map layer. There are some enlargement and cross section sheets. Some maps do not show single phase services unless they are long and deviating. There are however some maps drawn using the mains and ways style. These are rare, but please be aware that they exist.

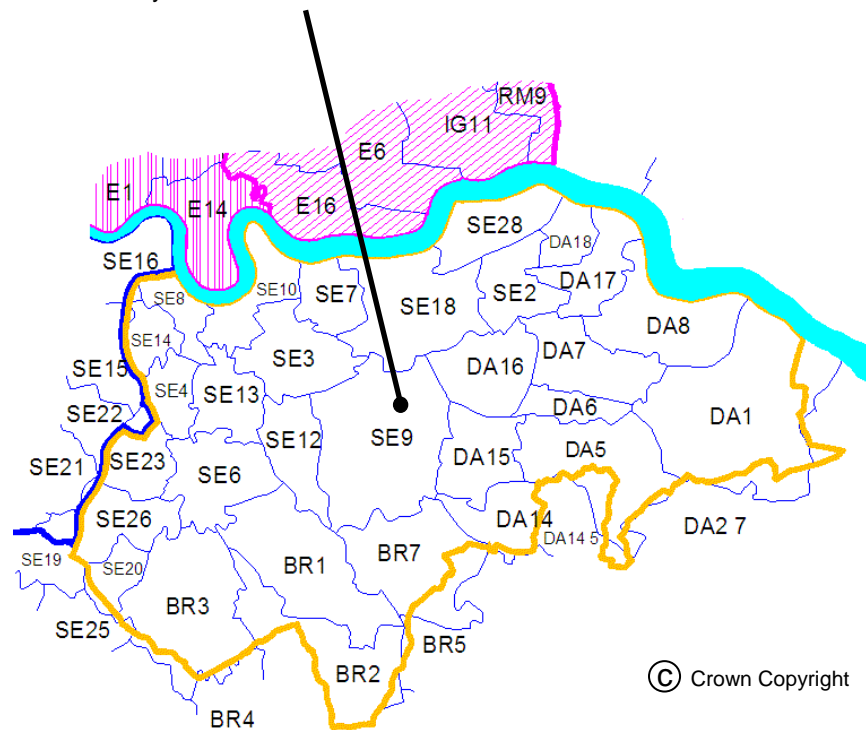

## Region 5 ex-Southern area

This region includes Southwark, Lambeth, Wandsworth, Merton, Kingston upon Thames and Richmond upon Thames. All maps are drawn to one style - single layer composite raster/vector.

### Region 5 (un-hatched)

#### Composite single layer (style 1) maps:

Composite maps - whenever possible, all the information is on one map layer. There are some enlargement and cross section sheets. A small number of maps may not show services.

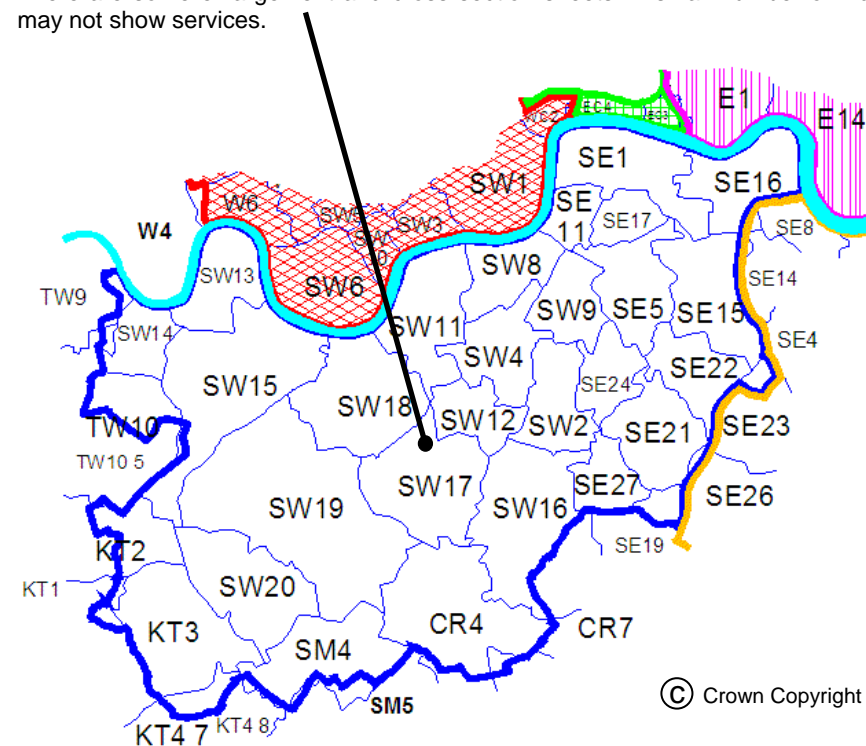

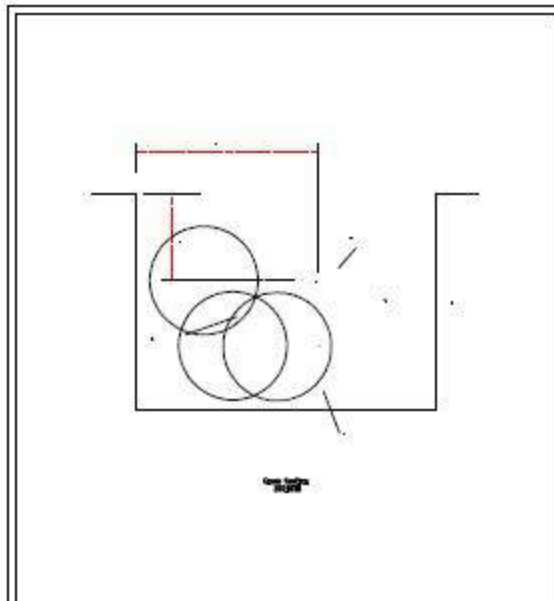

41141000-00
41142000-00
41143000-00
41144000-00
41145000-00
41146000-00
41147000-00
41148000-00
41149000-00
41150000-00
41151000-00
41152000-00
41153000-00
41154000-00
41155000-00
41156000-00
41157000-00
41158000-00
41159000-00
41160000-00
41161000-00
41162000-00
41163000-00
41164000-00
41165000-00
41166000-00
41167000-00
41168000-00
41169000-00
41170000-00
41171000-00
41172000-00
41173000-00
41174000-00
41175000-00
41176000-00
41177000-00
41178000-00
41179000-00
41180000-00
41181000-00
41182000-00
41183000-00
41184000-00
41185000-00
41186000-00
41187000-00
41188000-00
41189000-00
41190000-00
41191000-00
41192000-00
41193000-00
41194000-00
41195000-00
41196000-00
41197000-00
41198000-00
41199000-00
41200000-00

PROJECT: [blank]  
 SHEET: [blank]  
 DATE: [blank]  
 DRAWN BY: [blank]  
 CHECKED BY: [blank]



**CAUTION**

DO NOT TOUCH THE ELECTRICAL EQUIPMENT.

THESE WIRING CONNECTIONS ARE FOR THE USE OF THE LOCAL ELECTRICAL CONTRACTOR.

NO. 1	NO. 2	NO. 3	NO. 4
		TO 2794 SW N	SW

DATE: [blank]



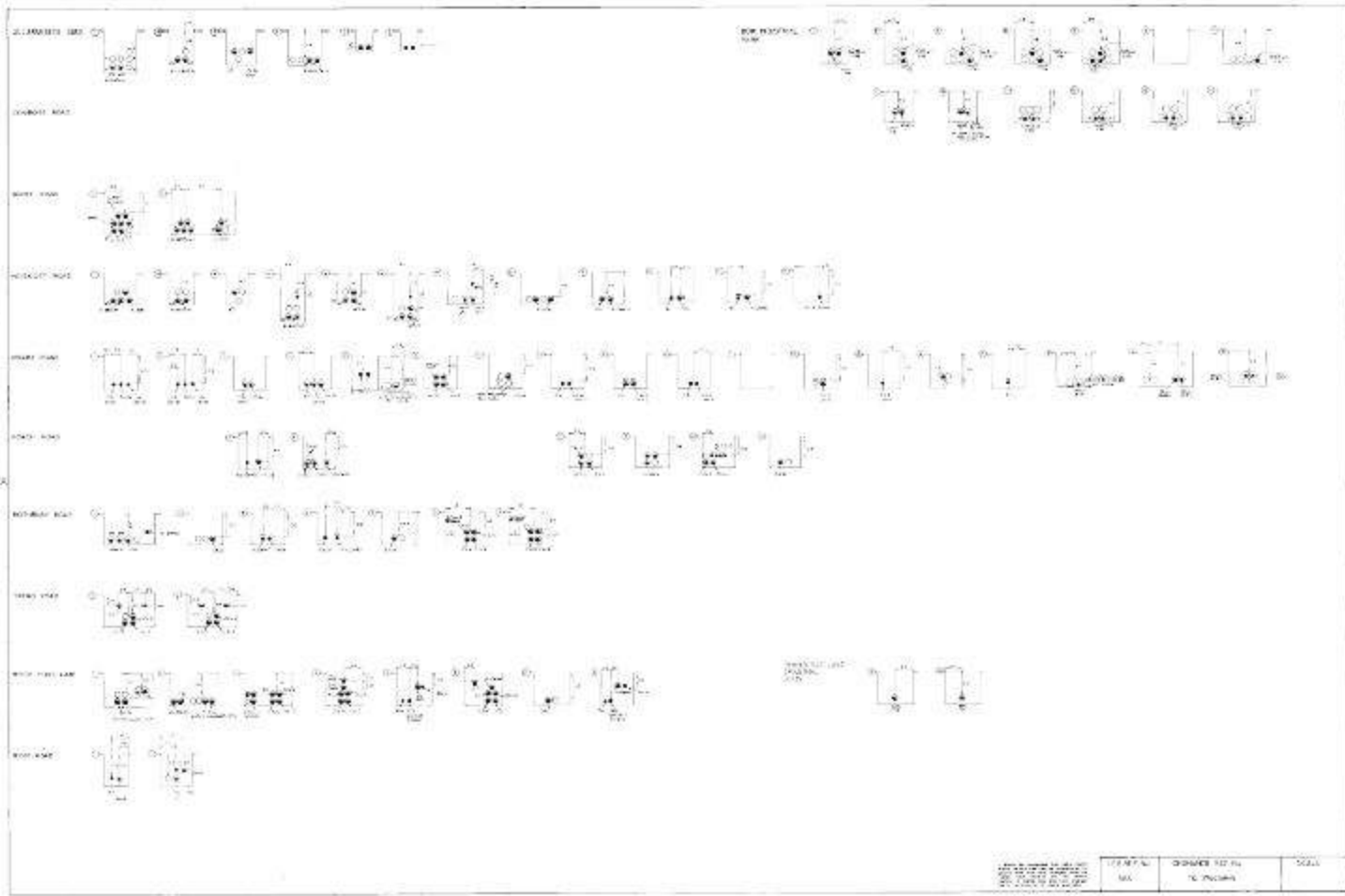

12-11  
100  
100



GROUNDING

GROUNDING

GROUNDING

GROUNDING

GROUNDING

GROUNDING

GROUNDING

GROUNDING

GROUNDING

GROUNDING

GROUNDING

GROUNDING

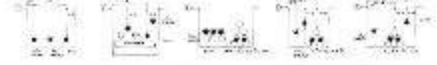
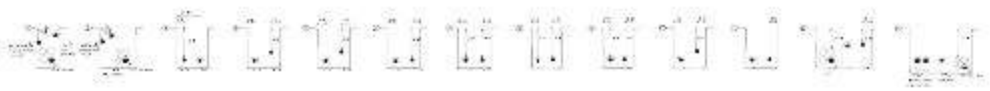

REVISIONS

NO.	DESCRIPTION	DATE
1	TO BRUCE-N	





PLAN VIEW OF  
SECTION 1



PLAN VIEW OF  
SECTION 2

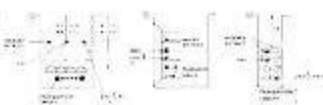

SCALE

SECTION 1  
SECTION 2  
SECTION 3

SECTION 1  
SECTION 2  
SECTION 3

SCALE

6A

6B

10000

9

10000  
 9500  
 9000  
 8500  
 8000  
 7500  
 7000  
 6500  
 6000  
 5500  
 5000  
 4500  
 4000  
 3500  
 3000  
 2500  
 2000  
 1500  
 1000  
 500  
 0

1. GENERAL NOTES

1. ALL WORK SHALL BE IN ACCORDANCE WITH THE LATEST EDITIONS OF THE STANDARD SPECIFICATIONS FOR HIGHWAY CONSTRUCTION, SEVENTH EDITION, 2003, AND THE STANDARD SPECIFICATIONS FOR MATERIALS, SEVENTH EDITION, 2003, AS AMENDED.
2. THE CONTRACTOR SHALL BE RESPONSIBLE FOR OBTAINING ALL NECESSARY PERMITS AND APPROVALS FROM THE APPROPRIATE AGENCIES.
3. THE CONTRACTOR SHALL MAINTAIN ACCESS TO ALL ADJACENT PROPERTIES AND UTILITIES AT ALL TIMES.
4. ALL UTILITIES SHALL BE PROTECTED AND DEEPENED AS NECESSARY TO MAINTAIN ADEQUATE COVER.
5. THE CONTRACTOR SHALL BE RESPONSIBLE FOR THE PROTECTION AND REPAIR OF ALL EXISTING UTILITIES AND STRUCTURES.
6. ALL MATERIALS AND METHODS SHALL BE APPROVED BY THE ENGINEER PRIOR TO CONSTRUCTION.
7. THE CONTRACTOR SHALL MAINTAIN ADEQUATE DRAINAGE AND EROSION CONTROL MEASURES THROUGHOUT THE PROJECT.
8. ALL WORK SHALL BE COMPLETED WITHIN THE SPECIFIED TIME FRAME.
9. THE CONTRACTOR SHALL BE RESPONSIBLE FOR THE PROTECTION AND REPAIR OF ALL EXISTING UTILITIES AND STRUCTURES.
10. ALL MATERIALS AND METHODS SHALL BE APPROVED BY THE ENGINEER PRIOR TO CONSTRUCTION.



**CAUTION:** ALL UTILITIES ARE SHOWN AS APPROXIMATE. THE CONTRACTOR SHALL VERIFY THE LOCATION AND DEPTH OF ALL UTILITIES PRIOR TO CONSTRUCTION.

DATE: 10/15/2024	SCALE: AS SHOWN	PROJECT: 10000	NO: 6A
<p>DESIGNED BY: [Signature]</p> <p>CHECKED BY: [Signature]</p> <p>DATE: 10/15/2024</p>		<p>PROJECT NO: 10000</p> <p>NO: 6A</p>	



TRAIL SIDE  
MANUFACTURING



TRAIL SIDE



TRAIL SIDE



TRAIL SIDE



TRAIL SIDE

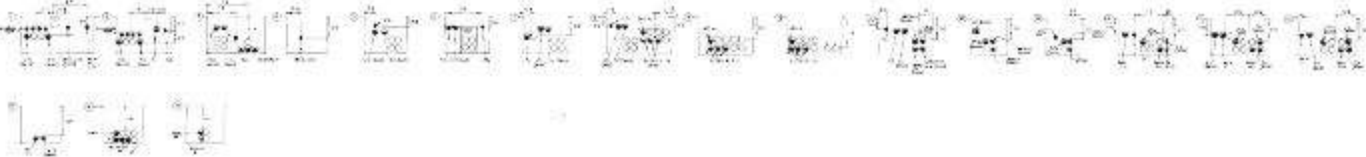



FOR DETAILS OF CABLES IN THIS AREA REFER TO THE RECORDS KEPT BY THE RECORDS DEPARTMENT OF LONDON ELECTRICITY PLC

1. 100mm²	1. 100mm²
2. 150mm²	2. 150mm²
3. 200mm²	3. 200mm²
4. 250mm²	4. 250mm²
5. 300mm²	5. 300mm²
6. 350mm²	6. 350mm²
7. 400mm²	7. 400mm²
8. 450mm²	8. 450mm²
9. 500mm²	9. 500mm²
10. 550mm²	10. 550mm²
11. 600mm²	11. 600mm²
12. 650mm²	12. 650mm²
13. 700mm²	13. 700mm²
14. 750mm²	14. 750mm²
15. 800mm²	15. 800mm²
16. 850mm²	16. 850mm²
17. 900mm²	17. 900mm²
18. 950mm²	18. 950mm²
19. 1000mm²	19. 1000mm²

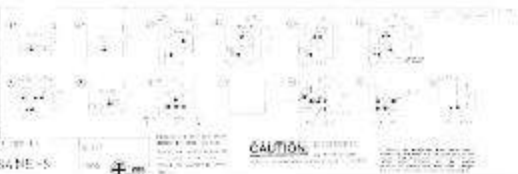

LEB  
 TO 3784 NE-S

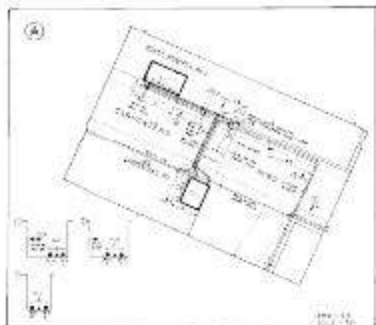

THIS DOCUMENT IS THE PROPERTY OF  
 THE UNIVERSITY OF CALIFORNIA  
 LIBRARY SYSTEMS  
 100 UNIVERSITY AVENUE  
 BERKELEY, CALIFORNIA 94720-5080  
 TEL: 415/495-1000 FAX: 415/495-1001  
 WWW: WWW.LIBRARY.UCB.EDU

**CAUTION** - DO NOT REMOVE OR DESTROY THIS DOCUMENT

FILE NO.	UNIVERSITY OF CALIFORNIA	SCALE
118	703754NE-5	AS SHOWN

Plan 146



PLATE NO.
PLATE NO.
PLATE NO.
PLATE NO.
PLATE NO.
PLATE NO.
PLATE NO.

14 B

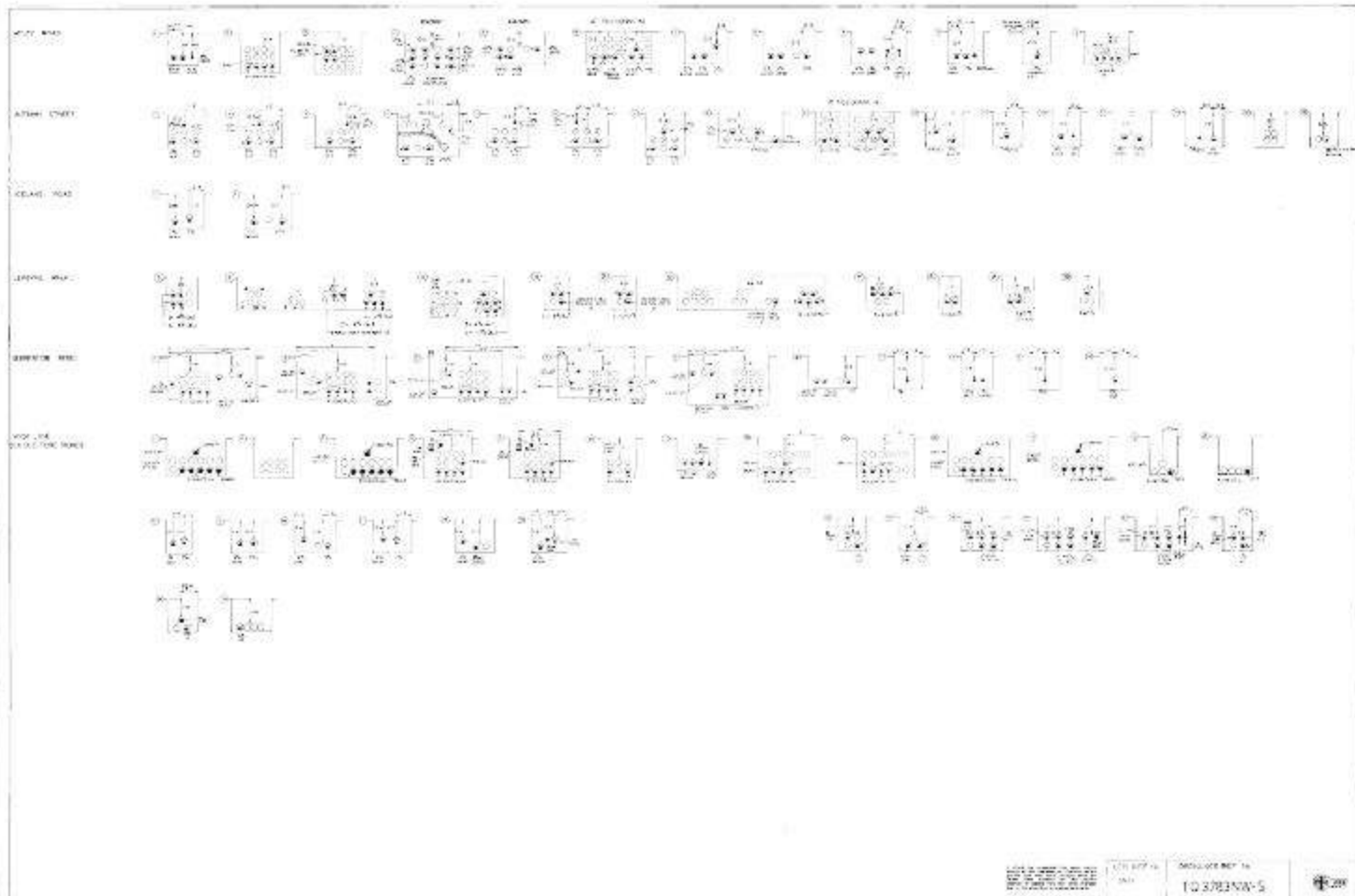

100-1000-0000  
100-1000-0000  
100-1000-0000

100-1000-0000  
100-1000-0000

100-1000-0000  
100-1000-0000







Scale

①



AWL 1250

②

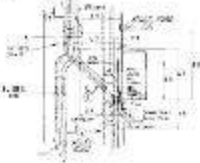

AWL 1250

**CAUTION:** IN APPROX.  
OPERATION ONLY. SEE INSTRUCTIONS.

AWL 1250  
AWL 1250  
AWL 1250  
AWL 1250

AWL 1250  
AWL 1250

AWL 1250  
AWL 1250

AWL 1250  
AWL 1250

PROVIDE A CLEAR  
AREA AROUND  
THE PERIPHERY

NO.	DATE	DESCRIPTION

1. The user must be at least 18 years old.  
2. The user must be a resident of the United States.  
3. The user must be a legal resident of the United States.  
4. The user must be a legal resident of the United States.

1. The user must be at least 18 years old.  
2. The user must be a resident of the United States.  
3. The user must be a legal resident of the United States.  
4. The user must be a legal resident of the United States.

**CAUTION:** The user must be at least 18 years old.  
The user must be a resident of the United States.  
The user must be a legal resident of the United States.  
The user must be a legal resident of the United States.

11

0000000000



0000000001

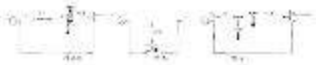

0000000010

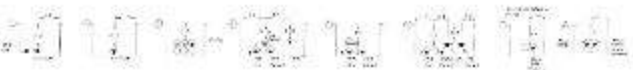

0000000011

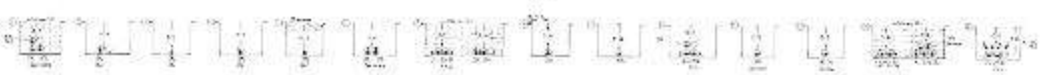

0000000100



0000000101



0000000110

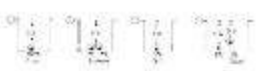

0000000111



0000001000



0000001001

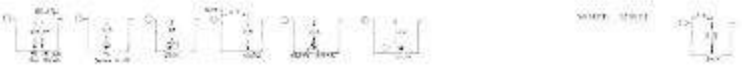

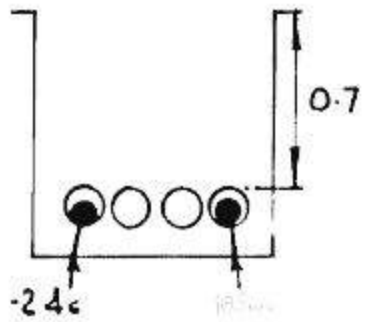

Cross Section  
1/2000

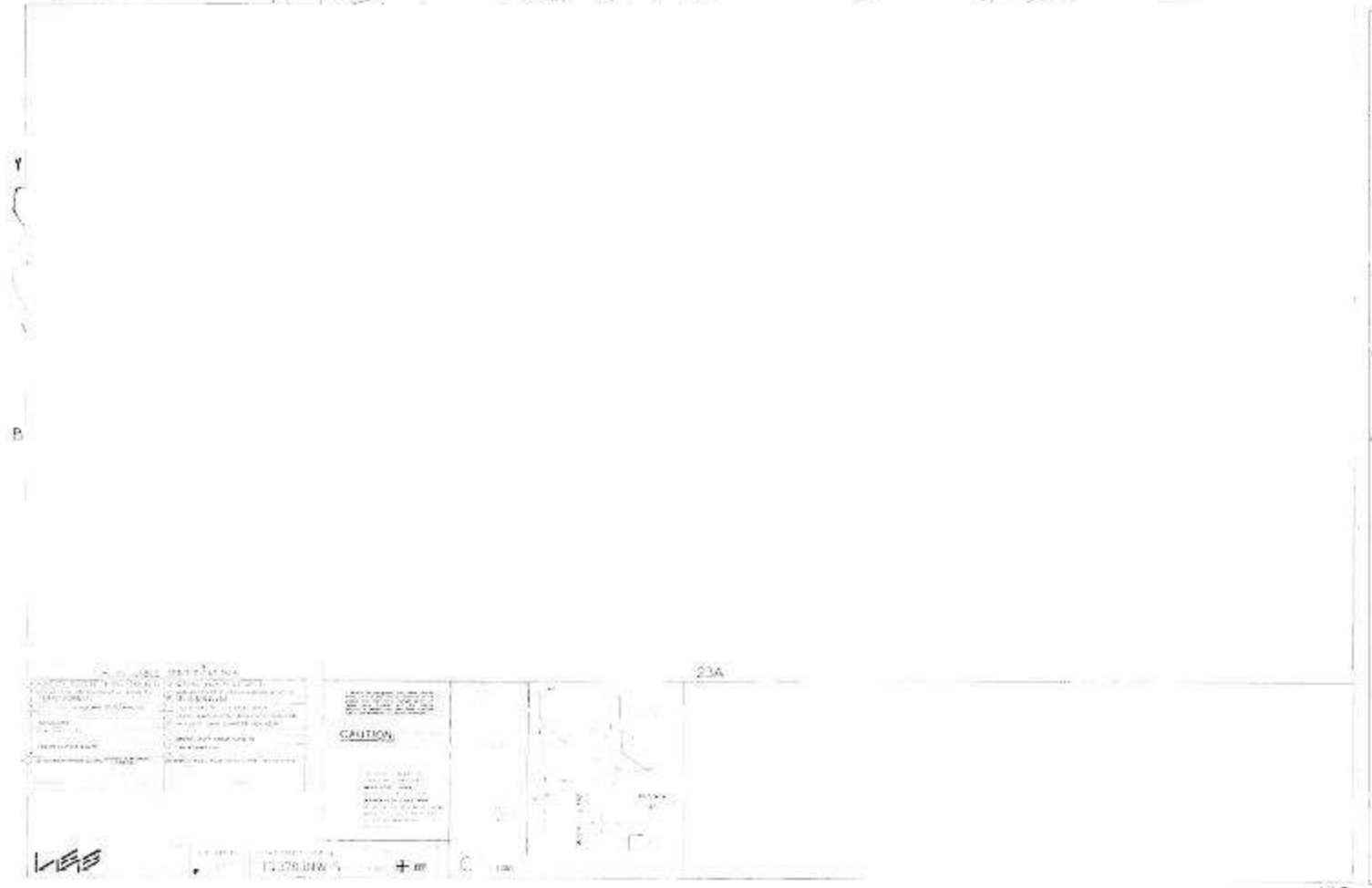

14 B
14 A
13 B
13 A
12 B
12 A
11 B
11 A
10 B
10 A
9 B
9 A
8 B
8 A
7 B
7 A
6 B
6 A
5 B
5 A
4 B
4 A
3 B
3 A
2 B
2 A
1 B
1 A

14 B

13 375.DWG 5

+

C

14 B

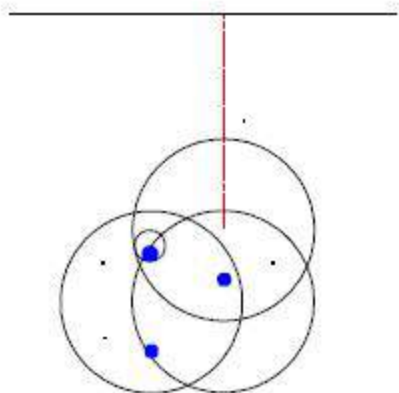

Cross Section  
2008944

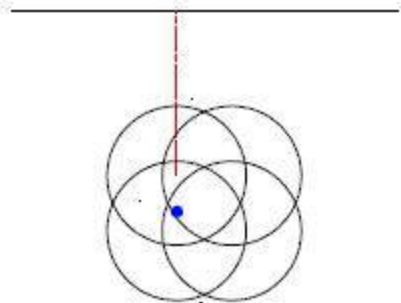

Cross Section  
2008944

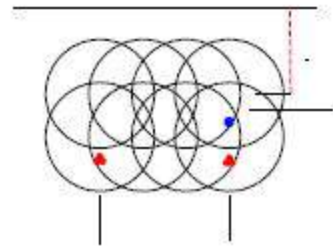

Cross Section  
2008944

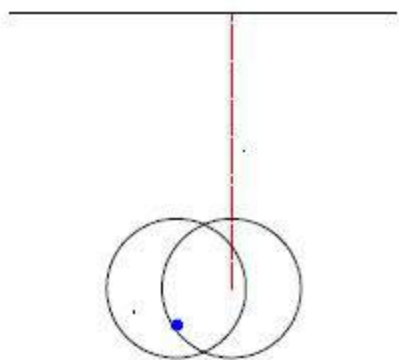

Cross Section  
2008944

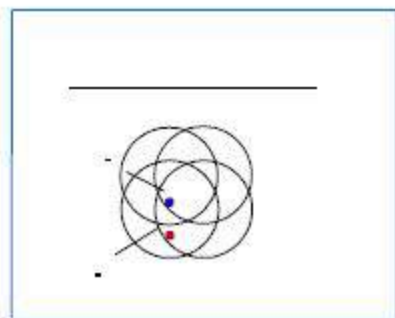

Cross Section  
2008944

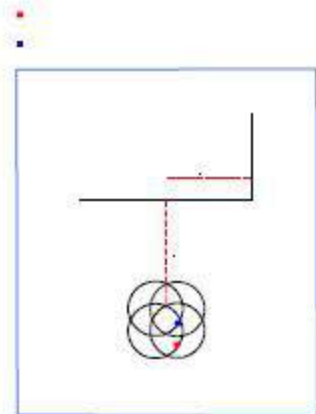

Cross Section  
2008944

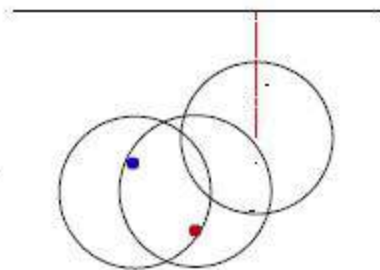

Circle Section  
207988

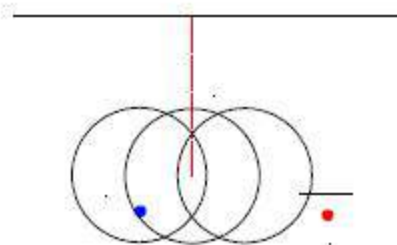

Circle Section  
208943

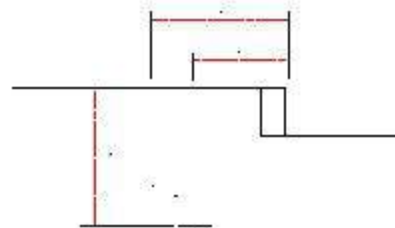

Circle Section  
208942

A

BWM\_0001

BWM\_0002

BWM\_0003

BWM\_0004

BWM\_0005

BWM\_0006

BWM\_0007

BWM\_0008

BWM\_0009





REPAIRABLE

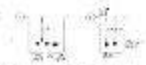

GENERAL USE - (SEE FIG. 100-100-1000)

REPAIRABLE

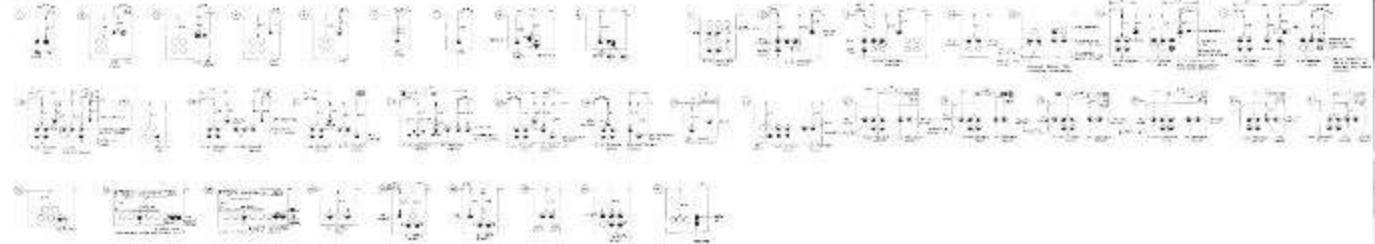

REPAIRABLE



REPAIRABLE



REPAIRABLE

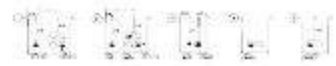

REPAIRABLE

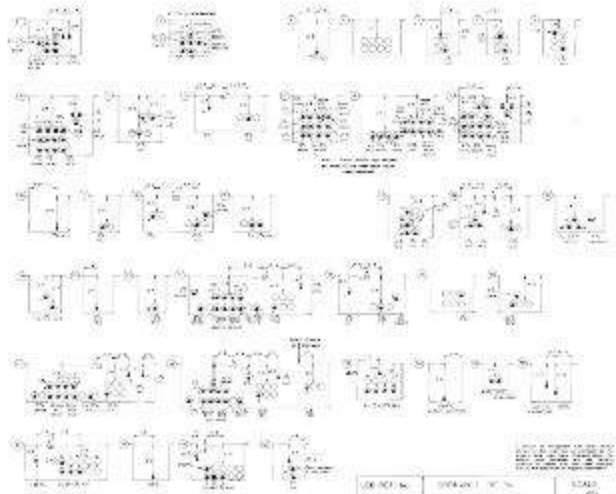

REPAIRABLE

REPAIRABLE  
10-100-1000  
SCALE

REPAIRABLE  
10-100-1000  
SCALE



Stephen Sawyer  
Technics Group  
Technics House  
Guildford  
Guildford  
Surrey  
GU4 7WA

**Date:** 20/03/2015

**Our Ref:** NL\_TE\_Z5\_3SWX\_140163

**Your Ref:** GRS00347

**RE: Proposed Works, Growing Concerns Garden Centre, 2 Wick Lane, Tower Hamlets, Greater London, E3 2NA**

Thank you for your enquiry which was received on 20/03/2015.  
Please note this response and any attached map(s) are valid for 28 days.

An assessment has been carried out with respect to National Grid Electricity Transmission plc's and National Grid Gas plc's apparatus. Please note it does not cover the items listed in the section "Your Responsibilities and Obligations", including gas service pipes and related apparatus.

**As your works are at a "proposed" stage, any maps and guidance provided are for information purposes only. This is not approval to commence work. You must submit a "Scheduled Works" enquiry at the earliest opportunity and failure to do this may lead to disruption to your plans and works. National Grid will endeavour to provide an initial assessment within 14 days of receipt of a Scheduled Works enquiry and dependent on the outcome of this, further consultation may be required.**

**In any event, for safety and legal reasons, works must not be carried out until a Scheduled Works enquiry has been completed and final response received.**

## Your Responsibilities and Obligations

The "Assessment" Section below outlines the detailed requirements that must be followed when planning or undertaking your scheduled activities at this location.

It is your responsibility to ensure that the information you have submitted is accurate and that all relevant documents including links are provided to all persons (either direct labour or contractors) working for you near National Grid's apparatus, e.g. as contained within the Construction (Design and Management) Regulations.

This assessment solely relates to National Grid Electricity Transmission plc (NGET) and National Grid Gas plc (NGG) apparatus. This assessment does **NOT** include:

- National Grid's legal interest (easements or wayleaves) in the land which restricts activity in proximity to National Grid's assets in private land. You must obtain details of any such restrictions from the landowner in the first instance and if in doubt contact National Grid.
- Gas service pipes and related apparatus
- Recently installed apparatus
- Apparatus owned by other organisations, e.g. other gas distribution operators, local electricity companies, other utilities, etc.

This communication does not constitute any formal agreement or consent for any proposed development work; either generally or with regard to National Grid's easements or wayleaves nor any planning or building regulations applications.

NGG and NGET or their agents, servants or contractors do not accept any liability for any losses arising under or in connection with this information. This limit on liability applies to all and any claims in contract, tort (including negligence), misrepresentation (excluding fraudulent misrepresentation), breach of statutory duty or otherwise. This limit on liability does not exclude or restrict liability where prohibited by the law nor does it supersede the express terms of any related agreements.

# ASSESSMENT

## Affected Apparatus

The National Grid apparatus that has been identified as being in the vicinity of your proposed works is:

- Low or Medium pressure (below 2 bar) gas pipes and associated equipment. (As a result it is highly likely that there are gas services and associated apparatus in the vicinity)
- Electricity Transmission underground cables and associated equipment

## Requirements

**BEFORE carrying out any work you must:**

- **Refer to the attached cable profile drawings (if any) which provide details about the location of National Grid's high voltage underground cables.**
- Carefully read these requirements including the attached guidance documents and maps showing the location of National Grid apparatus.
- Contact the landowner and ensure any proposed works in private land do not infringe National Grid's legal rights (i.e. easements or wayleaves). If the works are in the road or footpath the relevant local authority should be contacted.
- Ensure that all persons, including direct labour and contractors, working for you on or near National Grid's apparatus follow the requirements of the HSE Guidance Notes HSG47 - 'Avoiding Danger from Underground Services' and GS6 – 'Avoidance of danger from overhead electric power lines'. This guidance can be downloaded free of charge at <http://www.hse.gov.uk>
- In line with the above guidance, verify and establish the actual position of mains, pipes, cables, services and other apparatus on site before any activities are undertaken.

# GUIDANCE

## **Electricity Underground Cables Guidance:**

<http://www.nationalgrid.com/NR/rdonlyres/1174F509-0F16-4B68-8CF6-63FE27919E0A/51895/ElectricityUndergroundCableguidance.pdf>

## **Excavating Safely - Avoiding injury when working near gas pipes:**

[http://www.nationalgrid.com/NR/rdonlyres/2D2EEA97-B213-459C-9A26-18361C6E0B0D/25249/Digsafe\\_leaflet3e2finalamends061207.pdf](http://www.nationalgrid.com/NR/rdonlyres/2D2EEA97-B213-459C-9A26-18361C6E0B0D/25249/Digsafe_leaflet3e2finalamends061207.pdf)

## **Standard Guidance**

### **Essential Guidance document:**

<http://www.nationalgrid.com/NR/rdonlyres/6D6525F9-59EB-4825-BA89-DBD7E68882C7/51319/EssentialGuidance.pdf>

### **General Guidance document:**

<http://www2.nationalgrid.com/WorkArea/DownloadAsset.aspx?id=35103>

### **Excavating Safely in the vicinity of gas pipes guidance (Credit card):**

<http://www.nationalgrid.com/NR/rdonlyres/A3D37677-6641-476C-9DDA-E89949052829/44257/ExcavatingSafelyCreditCard.pdf>

### **Excavating Safely in the vicinity of electricity cables guidance (Credit card):**

<http://www.nationalgrid.com/NR/rdonlyres/35DDEC6D-D754-4BA5-AF3C-D607D05A25C2/44858/ExcavatingSafelyCreditCardelectricitycables.pdf>



ID: NL\_TE\_Z5\_3SWX\_140163  
 USER: utilityreports  
 DATE: 20/03/2015  
 DATA DATE: 19/03/2015  
 REF: GRS00347  
 MAP REF: TQ3684  
 CENTRE: 536838, 184052

View extent: 1445m, 785m

LP MAINS	
MP MAINS	
IP MAINS	
LHP MAINS	
NHP MAINS	

0m 100m  
 Approximate scale 1:5000  
 on A4 Colour Landscape

**Map not to be used for construction**

This plan shows those pipes owned by National Grid Gas plc in its role as a Licensed Gas Transporter (GT). Gas pipes owned by other GTs, or otherwise privately owned, may be present in this area. Information with regard to such pipes should be obtained from the relevant owners. The information shown on this plan is given without warranty, the accuracy thereof cannot be guaranteed. Service pipes, valves, syphons, stub connections, etc., are not shown but their presence should be anticipated. No liability of any kind whatsoever is accepted by National Grid Gas plc or their agents, servants or contractors for any error or omission. Safe digging practices, in accordance with HS(G)47, must be used to verify and establish the actual position of mains, pipes, services and other apparatus on site before any mechanical plant is used. It is your responsibility to ensure that this information is provided to all persons (either direct labour or contractors) working for you on or near gas apparatus. The information included on this plan should not be referred to beyond a period of 28 days from the date of issue.

Map 1 of 2 (GAS)

MAPS Plot Server Version 1.8.0



Requested by: Technics Group

This plan is reproduced from or based on the OS map by National Grid Gas plc, with the sanction of the controller of HM Stationery Office. Crown Copyright Reserved. Ordnance Survey Licence number 100024886

Valve	Depth of Cover	Syphon	Diameter Change	Material Change
-------	----------------	--------	-----------------	-----------------



ID: NL\_TE\_Z5\_3SWX\_140163  
 USER: utilityreports  
 DATE: 20/03/2015  
 DATA DATE: 04/07/2014  
 REF: GRS00347  
 MAP REF: TQ3684  
 CENTRE: 536838, 184052

View extent: 2890m, 1570m  
 Underground cables   
 Overhead lines   
 0m  200m  
 Approximate scale 1:10000  
 on A4 Colour Landscape

**Map not to be used for construction**

This plan shows those cables owned by National Grid Electricity Transmission plc in its role as a Licensed Electricity Transporter (ET). Electricity cables owned by other ETs, or otherwise privately owned, may be present in this area. Information with regard to such cables should be obtained from the relevant owners. The information shown on this plan is given without warranty, the accuracy thereof cannot be guaranteed. Ancillary equipment such as cooling systems and communication cables are not shown but their presence should be anticipated. No liability of any kind whatsoever is accepted by National Grid Electricity Transmission plc or their agents, servants or contractors for any error or omission. Safe digging practices, in accordance with HS(G)47, must be used to verify and establish the actual position of cables and other apparatus on site before any mechanical plant is used. It is your responsibility to ensure that this information is provided to all persons (either direct labour or contractors) working for you on or near electricity apparatus. The information included on this plan should not be referred to beyond a period of 28 days from the date of issue.

Map 2 of 2 (ELECTRIC)  
 MAPS Plot Server Version 1.8.0  
  
 Requested by: Technics Group  
 This plan is reproduced from or based on the OS map by National Grid Electricity Transmission plc, with the sanction of the controller of HM Stationery Office. Crown Copyright Reserved. Ordnance Survey Licence number 100024241

# ENQUIRY SUMMARY

## Received Date

20/03/2015

## Your Reference

GRS00347

## Location

Centre Point: 536838, 184052

X Extent: 303

Y Extent: 276

Postcode: E3 2NA

Location Description: Growing Concerns Garden Centre, 2 Wick Lane, Tower Hamlets, Greater London, E3 2NA

## Map Options

Paper Size: A4

Orientation: LANDSCAPE

Requested Scale: 2500

Actual Scale: 1:5000 (GAS), 1:10000 (ELECTRIC)

Real World Extents: 1445m x 785m (GAS), 2890m x 1570m (ELECTRIC)

## Recipients

utility.reports@technicsgroup.com

## Enquirer Details

Organisation Name: Technics Group

Contact Name: Stephen Sawyer

Email Address: utility.reports@technicsgroup.com

Telephone: 01483 230080

Address: Technics House, Guildford, Guildford, Surrey, GU4 7WA

## Description of Works

Growing Concerns Garden Centre, 2 Wick Lane, Tower Hamlets, Greater London, E3 2NA

## Enquiry Type

Proposed Works

## Activity Type

Utility Works

## Work Types

Work Type: Plans Only



THIS DOCUMENT IS FOR VIEWING PURPOSES ONLY - NOT TO BE TREATED AS THE MASTER DRAWING

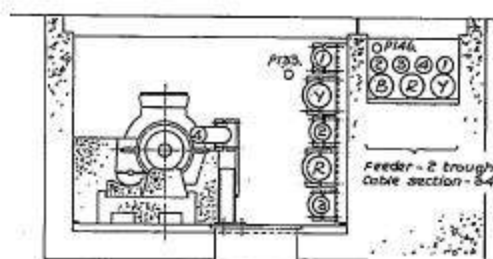
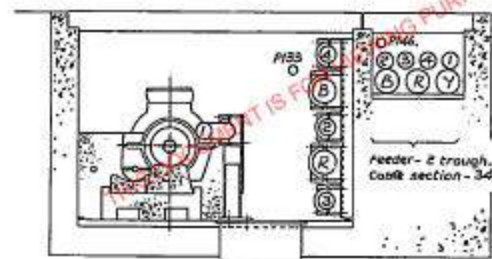
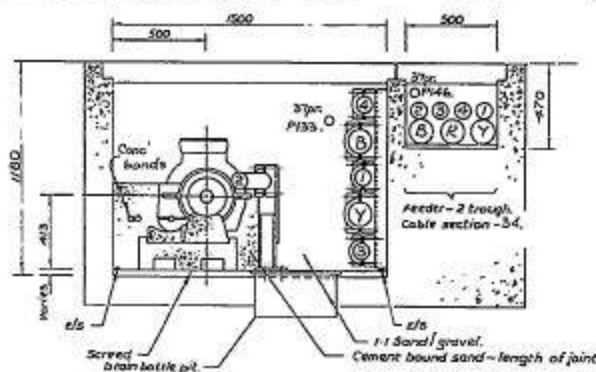
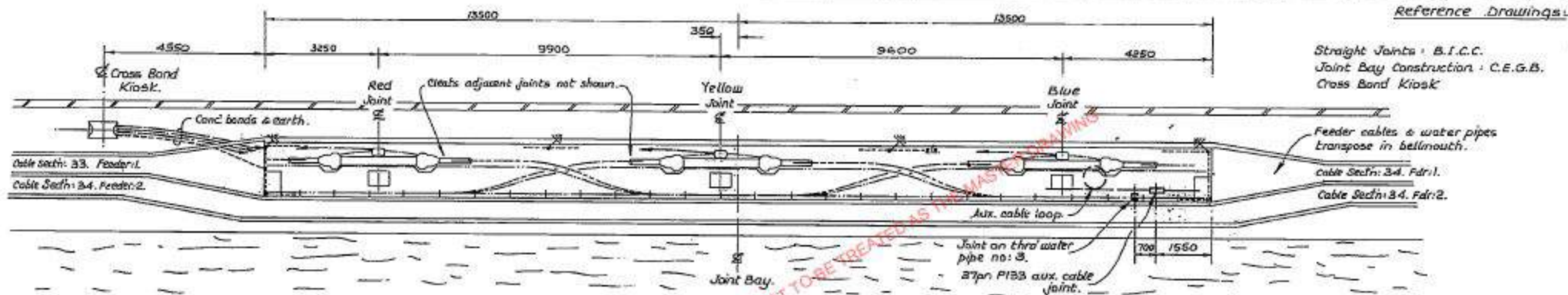

Jointing Details ~ Feeder Cables.			
Phase	Type of Cable.	Jointer.	Date.
R	400 kv. S.C. 2000 <sup>o</sup> mm. all filled. lead sheath.	D. Kerr.	10-7-80
Y	—	—	15-7-80
B	—	—	18-7-80

Jointing Details ~ Auxiliary Cables.			
	Type of Cable.	Jointer.	Date.
P153	37pn 1/0-5mm. Pe. Pa. Awl. Pe. jelly filled.	B. Mansfield.	25-7-80

70/3620 SHT 108

Cross Sections Facing West Nam. Scale - 1:25

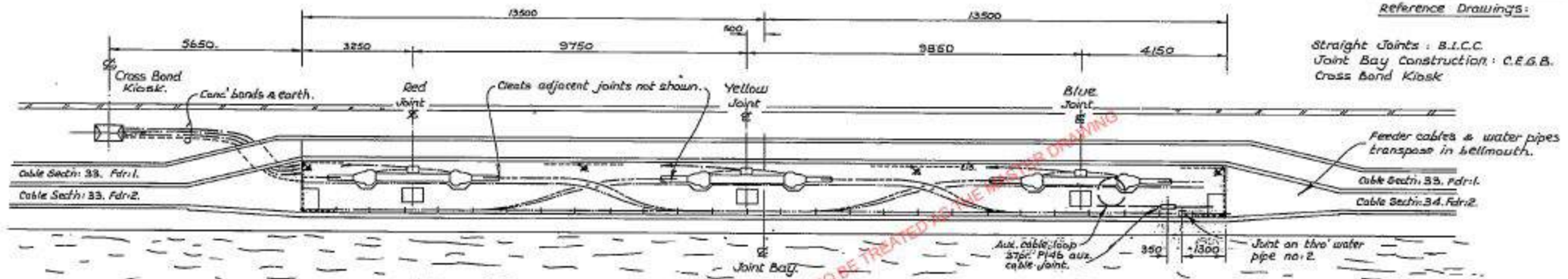

Reference Drawings:  
 Straight Joints: B.I.C.C. : E95480-D1.  
 Joint Bay Construction: C.E.G.B. : 16/16.307 rev. A.  
 Cross Bond Kiosk : E90348-D3.

Layout of Straight Joint Bay - 33/34. Scale - 1:100

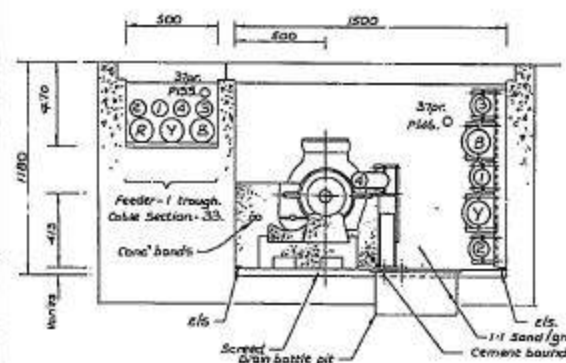

Section on Red Phase Joint.

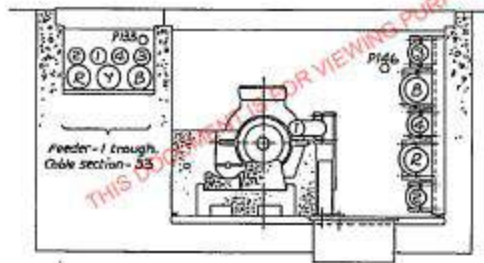

Section on Yellow Phase Joint.

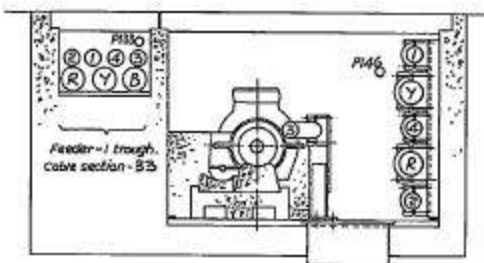

Section on Blue Phase Joint.

THIS DOCUMENT IS FOR VIEWING PURPOSES ONLY - NOT TO BE TREATED AS THE MASTER DRAWING

Phase	Type of Cable.	Jointer.	Date.
R	400 kv. S.C. 2000 <sup>2</sup> mm. oil filled, lead sheath.	D. Kerr.	14-2-80
Y	—	—	11-2-80
B	—	—	6-2-80

	Type of Cable.	Jointer	Date.
P146	37pc. 1/0.3mm. P.C. P.C. A.W.A. P.C. jelly filled.	J. Kerridge.	28-8-80

70/3620 SHT 109

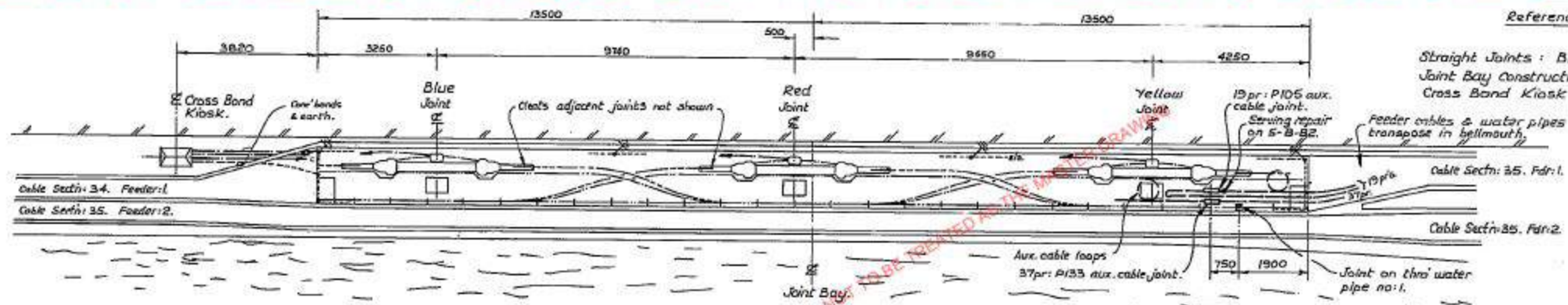

Reference Drawings:

- Straight Joints : B.I.C.C. : E95480 - D1.
- Joint Bay Construction : C.E.G.B : 16/163/10 rev.B.
- Cross Bond Kiosk : E90348 - D3.

Layout of Straight Joint Bay ~ 34/35, Scale - 1:100

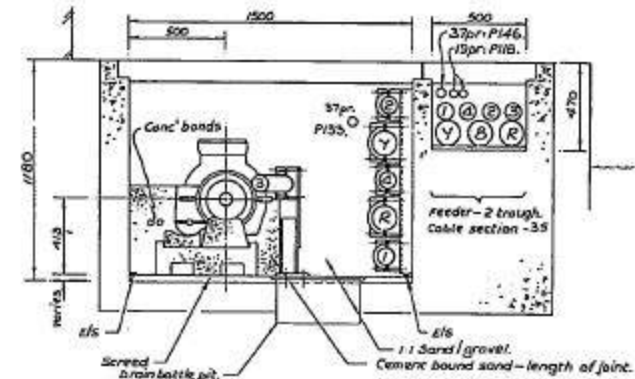

Section on Blue Phase Joint.

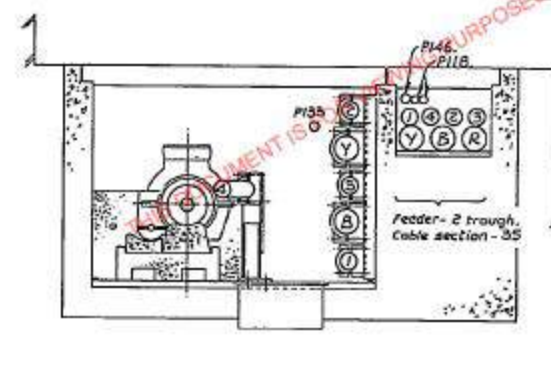

Section on Red Phase Joint.

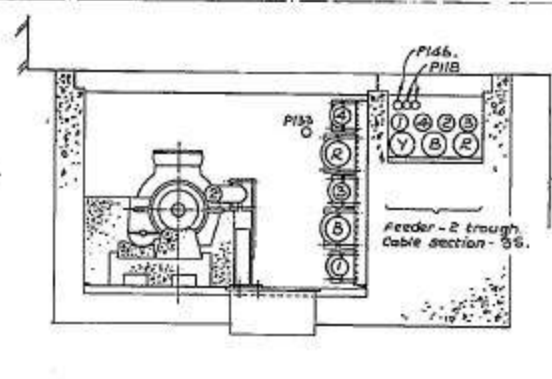

Section on Yellow Phase Joint.

Cross Sections Facing West Ham, Scale - 1:25.

Jointing Details ~ Feeder Cables.

Phase	Type of Cable.	Jointer	Date
R	400 kv. B.C. 2000 <sup>2</sup> mm. oil filled, lead sheath.	V. Stuchbury.	20-11-81.
Y	—	—	25-11-81.
B	—	—	17-11-81.

Jointing Details ~ Auxiliary Cables.

	Type of Cable	Jointer	Date.
P133	37pr. 1/0.9mm. Pe. Pe. AWA. Pe. jelly filled.	B. Mansfield.	13-1-82.
P105	19pr. 1/0.9mm. Pe. Pe. AWA. Pe. jelly filled.	—	14-1-82.

70/3620 SHT 113

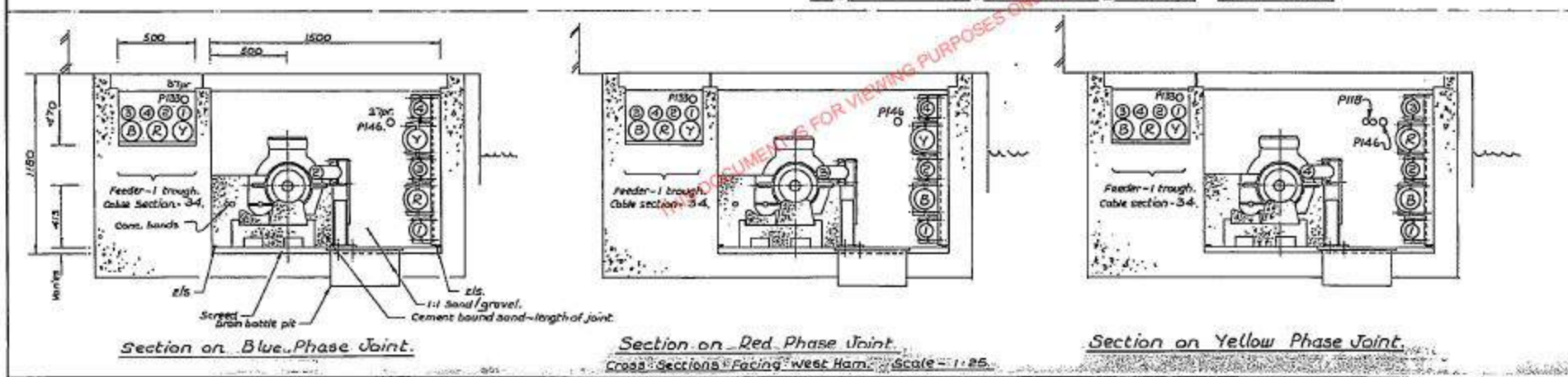
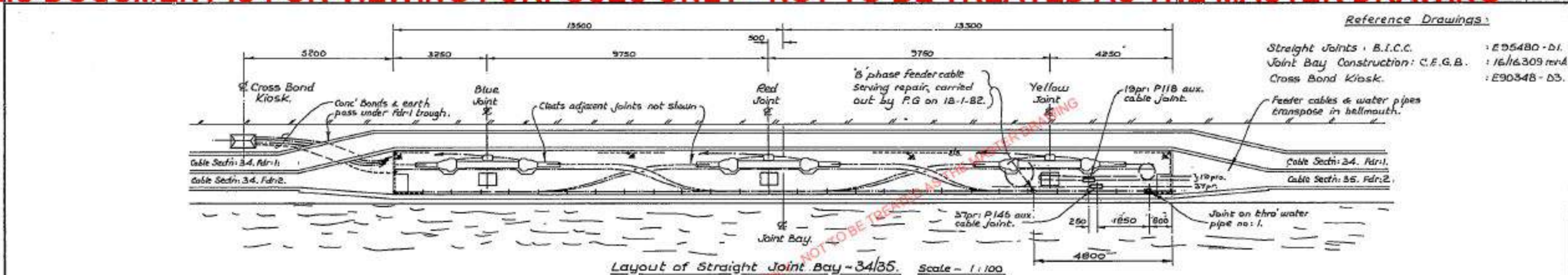

**Jointing Details ~ Feeder Cables.**

Phase	Type of Cable.	Jointer.	Date.
R	400 kv. S.C. 2000 mm. all filled. Lead sheath.	V. Stuchbury.	4-12-81.
Y	—	—	1-12-81.
B	—	—	9-12-81.

**Jointing Details ~ Auxiliary Cables.**

	Type of Cable.	Jointer.	Date.
P146	57pr. 110.9mm. Pz. Pe. AWA. Pe. jelly filled.	B. Mansfield.	19-1-82.
P118	19pr. 110.9mm. Pe. Pe. AWA. Pe. jelly filled.	—	23-1-82.

THIS DOCUMENT IS FOR VIEWING PURPOSES ONLY - NOT TO BE TREATED AS THE MASTER DRAWING

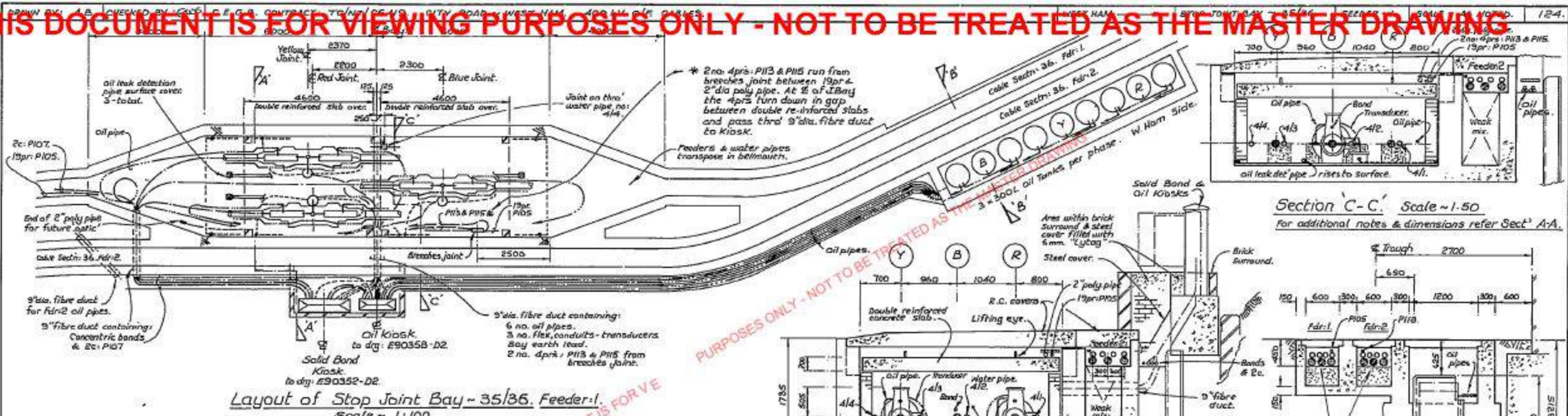

Layout of Stop Joint Bay ~ 35/36, Feeder 1.  
Scale ~ 1:100.

Symbols Key.	
-----	Feeder Cable.
-----	Water Pipe.
-----	Aux. cable.
-----	Earth.
-----	Oil Pipe.
-----	Transducer Lead.
-----	Conc. Bond.
-----	2" dia. poly pipe.

Joining Details				
Joint.	Phase	Type of Cable	Joiner.	Date.
Firelli General Stop Joints to PG. drg. no: 5610bl.	R.	400 kv S.C. 2000 <sup>9</sup> mm. Oil Filled, Lead Sheath.	E. Finch.	17-6-80
	Y.		E. Finch.	10-6-80
	B.		E. Finch.	3-6-80
19pr. aux.	P105	19pr. 1/4-2mm. Pp. Pp. Anvl. Pp. Jetty Filled.	B. Mansfield	2-10-81

THIS DOCUMENT IS FOR VIEWING PURPOSES ONLY - NOT TO BE TREATED AS THE MASTER DRAWING

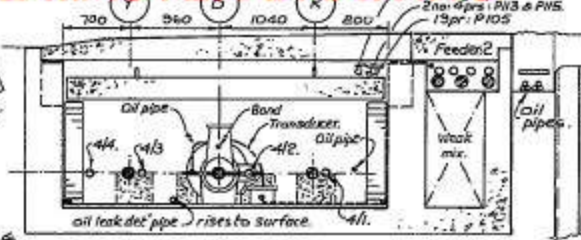

Section 'C-C' Scale ~ 1:50  
For additional notes & dimensions refer Sect' A-A.

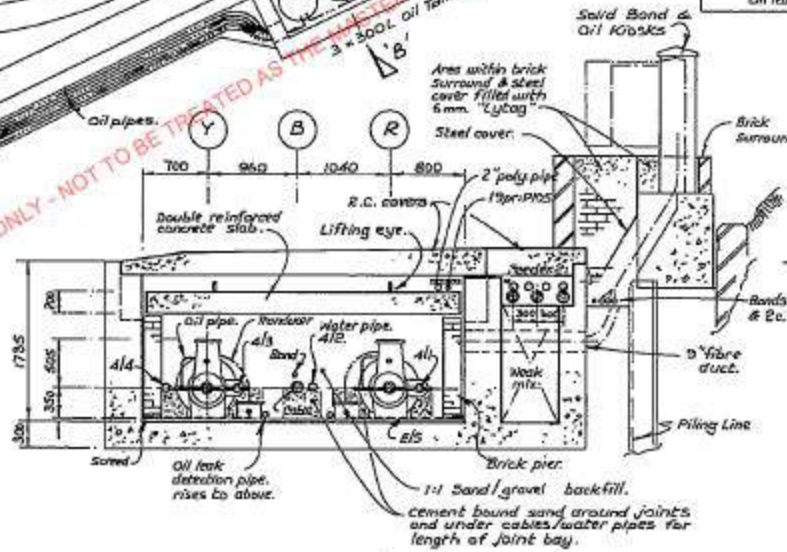

Section 'A-A' Scale ~ 1:50.

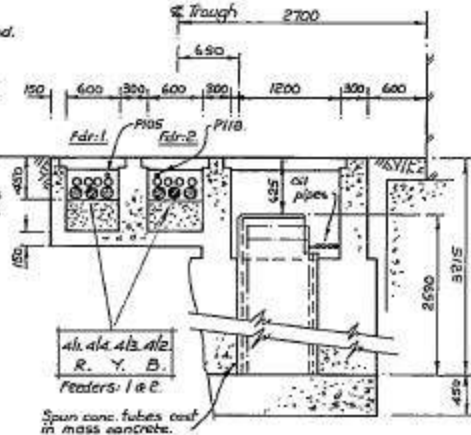

Section 'B-B' Scale ~ 1:50.

70/3620 SHT 125

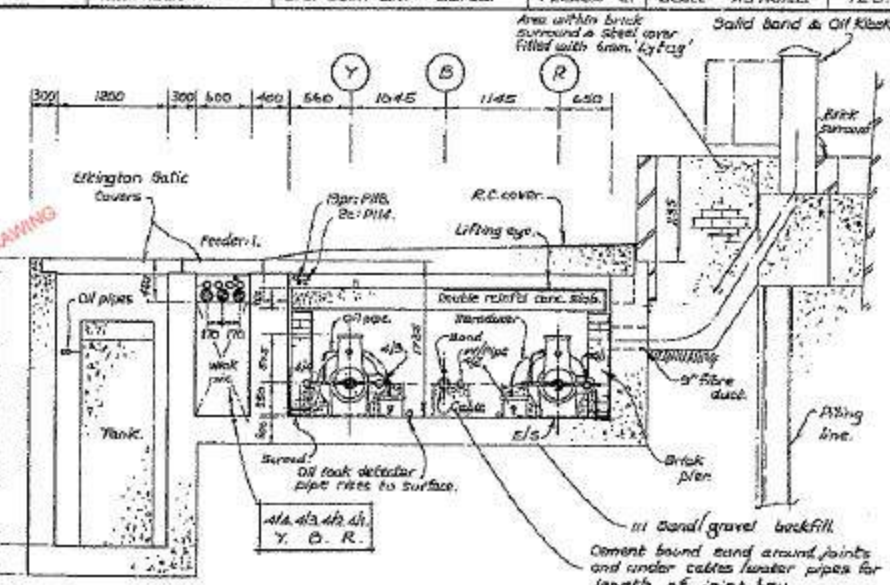
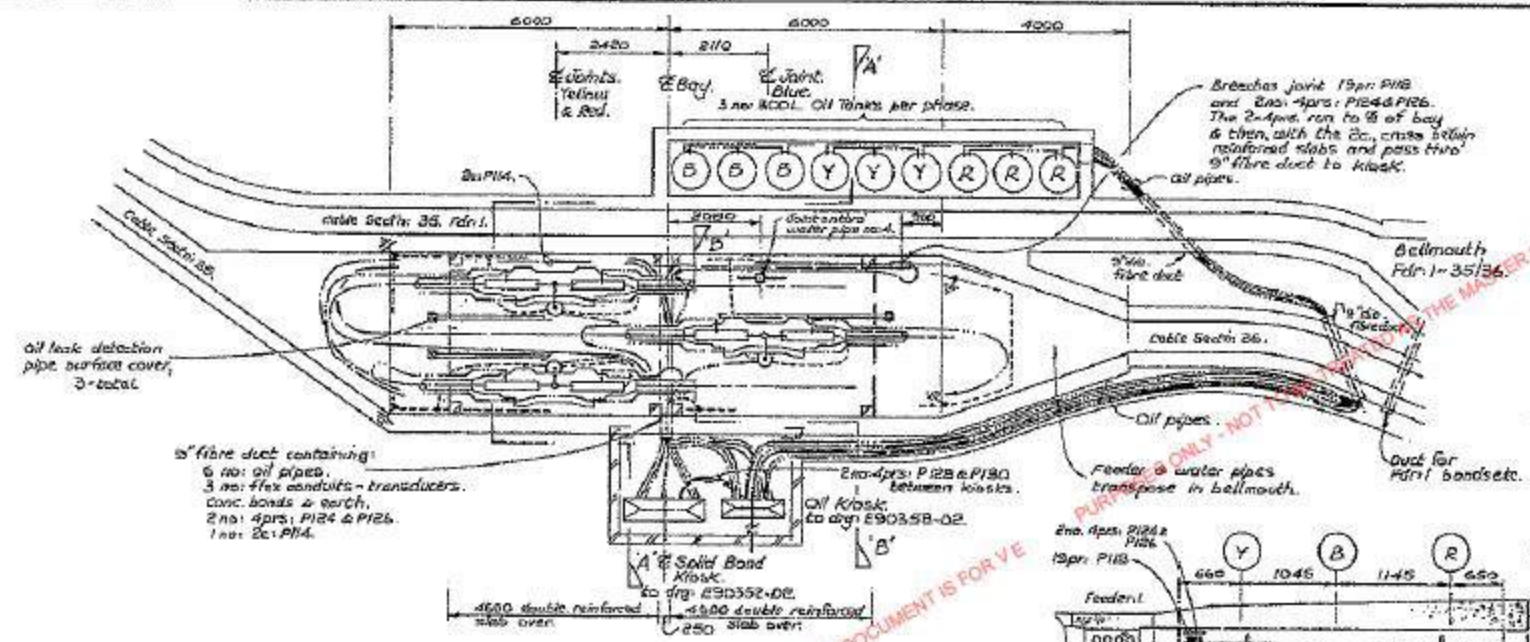

Layout of Stop Joint Bay - 35/36.  
Feeder-2. Scale - 1:100.

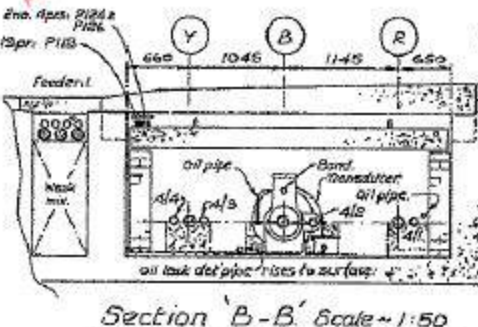

Section B-B' Scale - 1:50

Section A-A' Scale - 1:50  
70/3620 SHT 126  
Jointing Details

Joint	Phase	Type of cable	Jointer	Date
Firelli General Stop Joints to R.C. dry rot 26/10/61.	R.	400 kv. S.C. 2000 <sup>mm</sup> . Oil Filled, Lead Sheath.	R.A. Ferryhough.	20-5-80
	Y.		R.A. Ferryhough.	22-5-80
	B.		R.A. Ferryhough.	4-6-80.
19pr. 1/2 2pr. P118.	P118.	19pr. 1/2 2pr. P118. AWA. P118. P124. P126. P128. P130. P132. P134. P136. P138. P140. P142. P144. P146. P148. P150. P152. P154. P156. P158. P160. P162. P164. P166. P168. P170. P172. P174. P176. P178. P180. P182. P184. P186. P188. P190. P192. P194. P196. P198. P200.	M. Gardiner.	11-11-81.

Symbols Key.

	Feeder cable.
	Water pipe.
	Aux. cable.
	Earth.
	Oil pipe.
	Transducer lead.
	Conc. band.

For additional notes & dimensions refer to Section A-A'

**THIS DOCUMENT IS FOR VIEWING PURPOSES ONLY - NOT TO BE TREATED AS THE MASTER DRAWING**

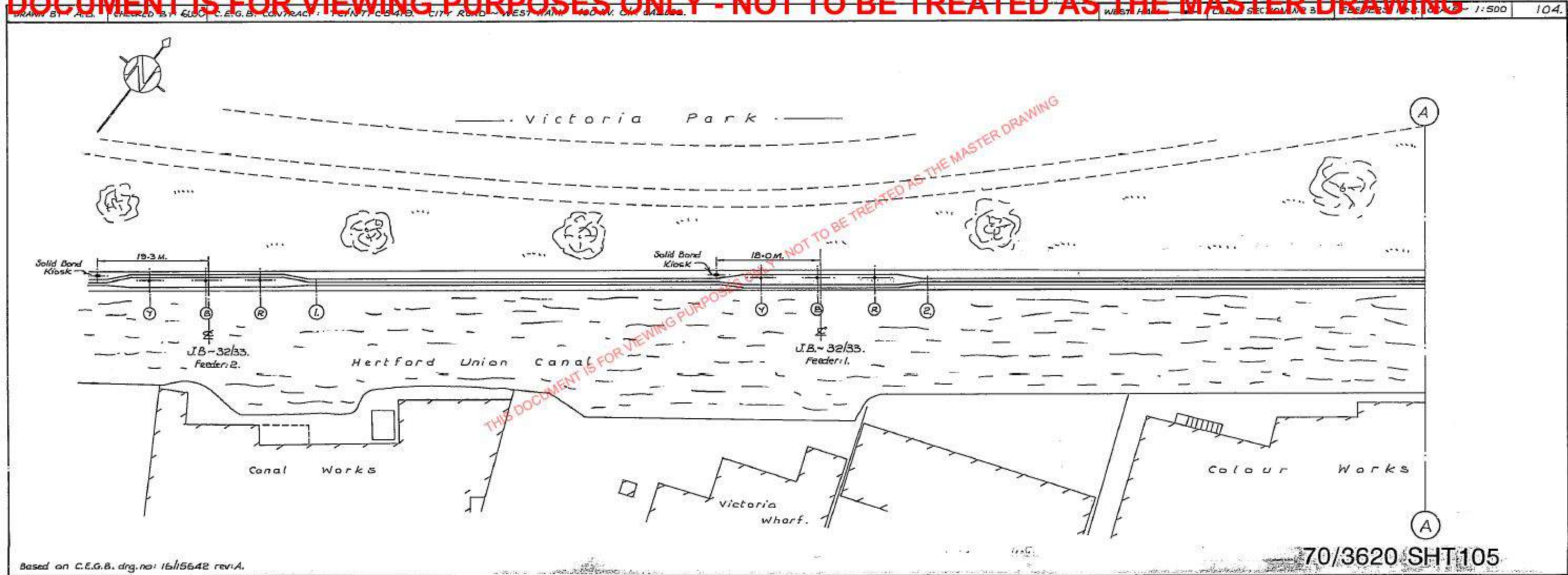

Based on C.E.G.B. drg. no: 16/15642 rev: A.

70/3620 SHT 105

THIS DOCUMENT IS FOR VIEWING PURPOSES ONLY - NOT TO BE TREATED AS THE MASTER DRAWING

DRAWN BY: A.B. CHECKED BY: GUC. C.E.G.B. CONTRACT: TC/INT/CSA19 CITY ROAD - WEST HAM 400KV O/E CABLES WEST HAM CABLE SECTION NO. 33 FEEDERS 1 & 2 SCALE 1:500 105.

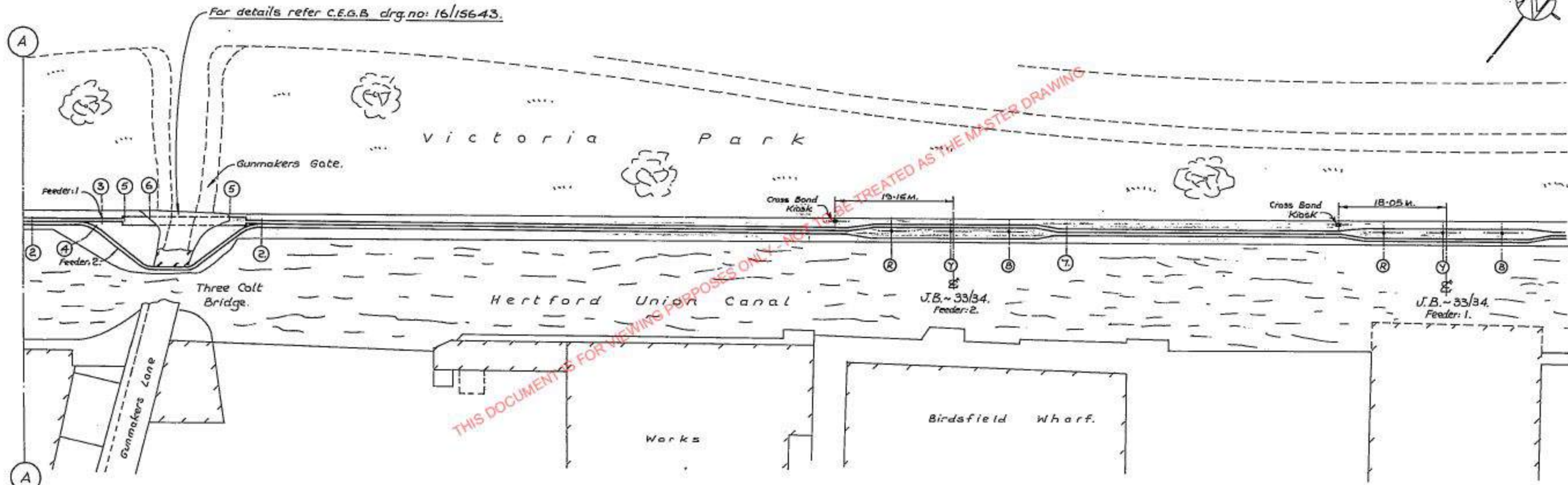

Based on C.E.G.B. drg.no: 16/15644.

70/3620 SHT 106



**THIS DOCUMENT IS FOR VIEWING PURPOSES ONLY - NOT TO BE TREATED AS THE MASTER DRAWING**

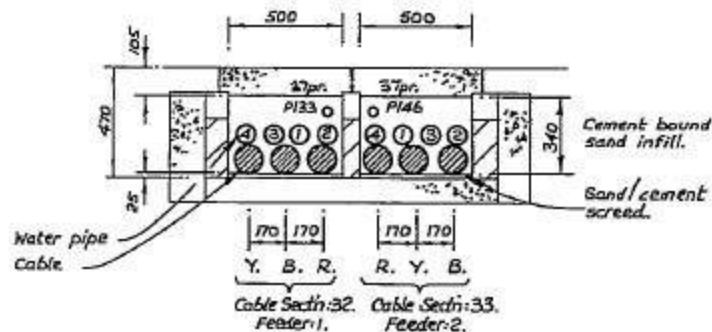

1.

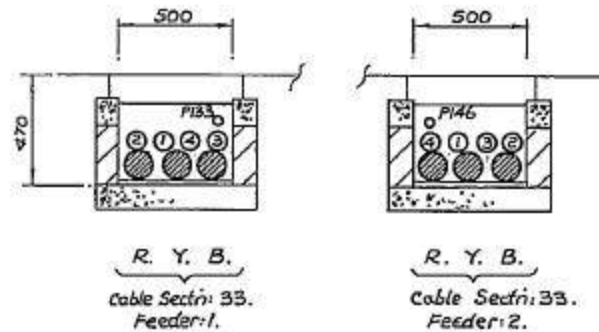

3.

4.

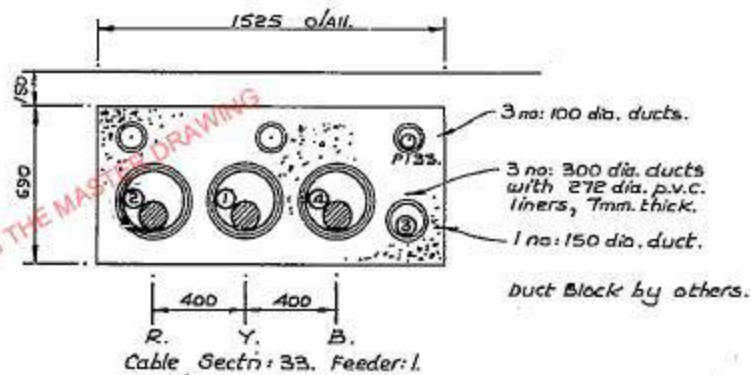

6.

For construction details refer to C.E.G.B. drg. no: 16/15643

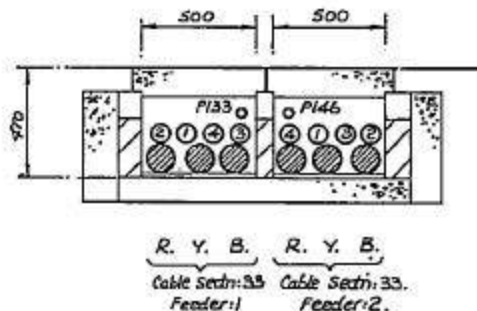

2.

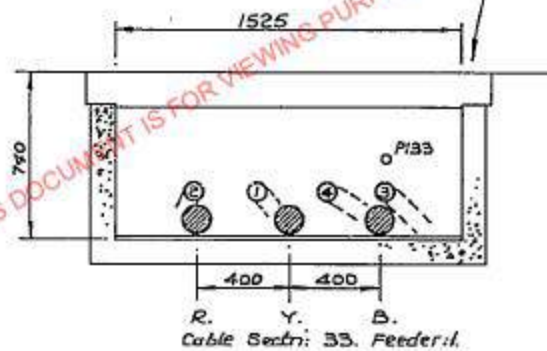

5.

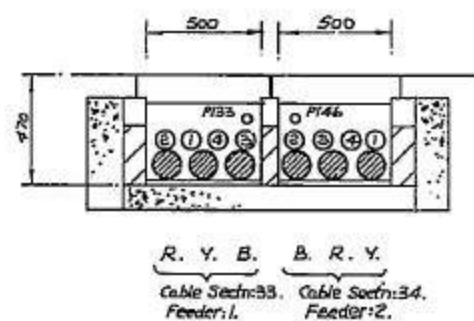

7.

Trough construction & base screed by others.

THIS DOCUMENT IS FOR VIEWING PURPOSES ONLY - NOT TO BE TREATED AS THE MASTER DRAWING

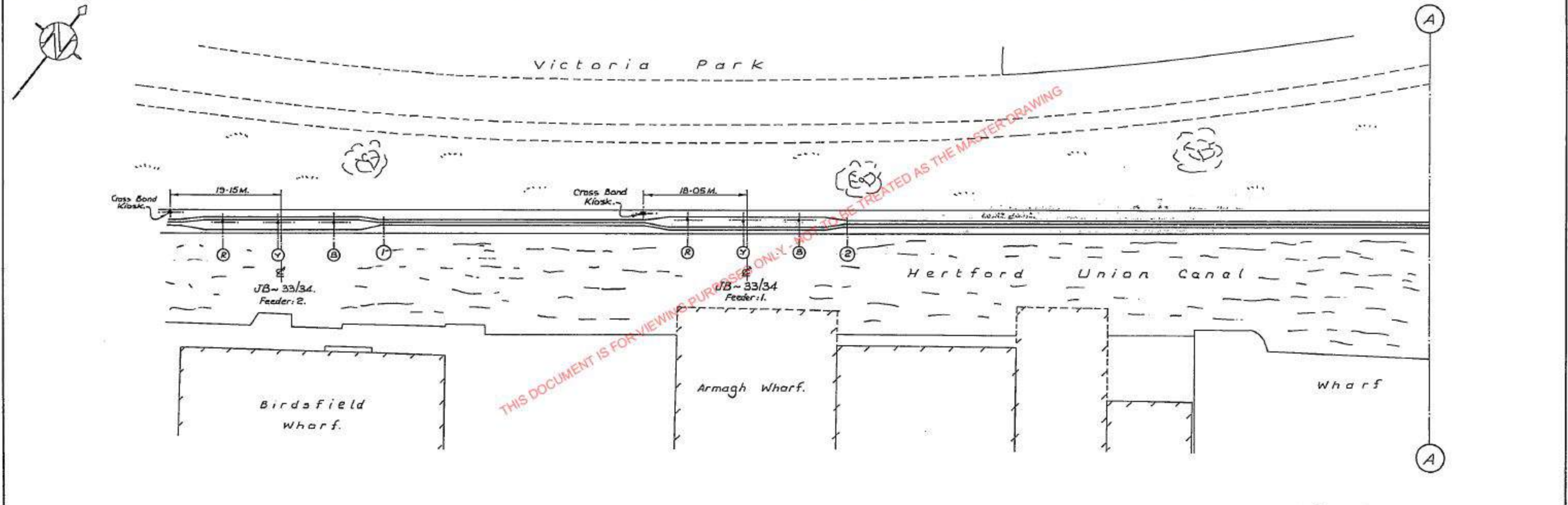

Based on C.E.G.B. drg. no: 16/15644.

70/3620 SHT 110

THIS DOCUMENT IS FOR VIEWING PURPOSES ONLY - NOT TO BE TREATED AS THE MASTER DRAWING

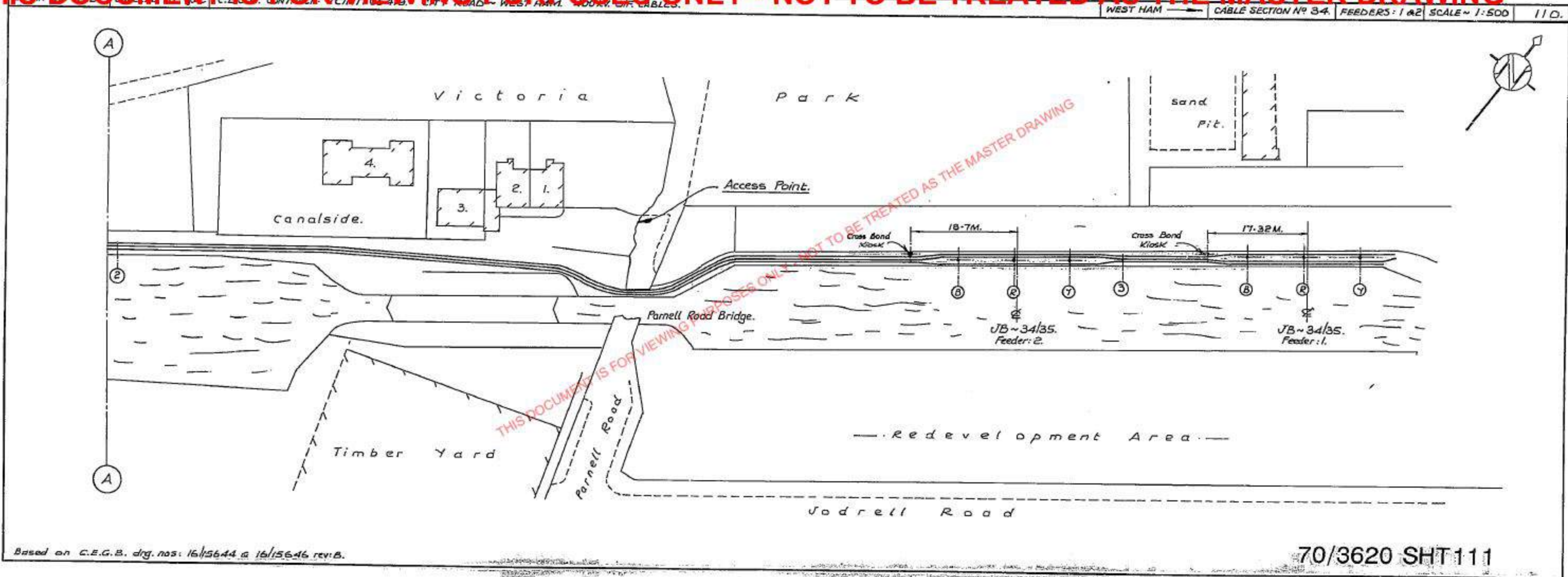

Based on C.E.G.B. drg. nos: 16/15644 & 16/15646 rev: B.

70/3620 SHT 111

THIS DOCUMENT IS FOR VIEWING PURPOSES ONLY - NOT TO BE TREATED AS THE MASTER DRAWING

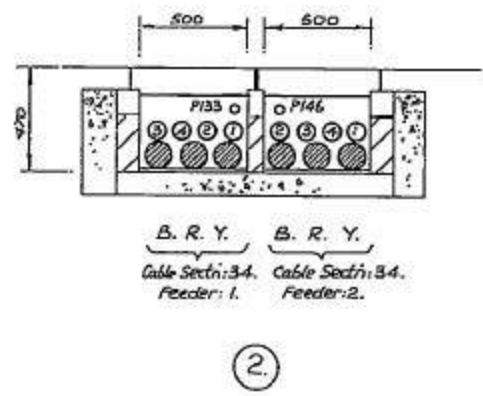
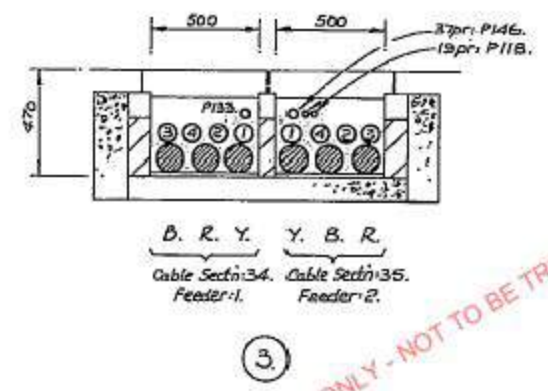
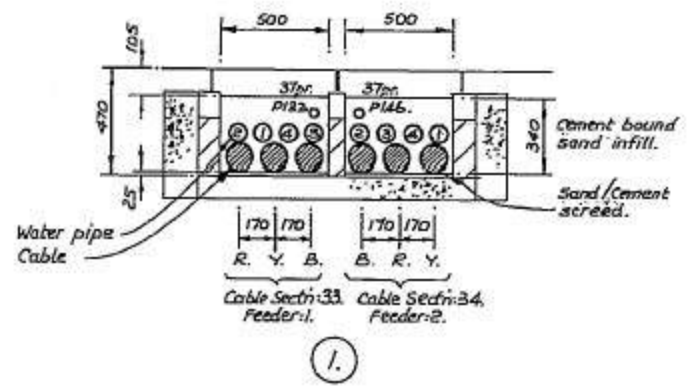

THIS DOCUMENT IS FOR VIEWING PURPOSES ONLY - NOT TO BE TREATED AS THE MASTER DRAWING

Trough construction & base screed by others.

**THIS DOCUMENT IS FOR VIEWING PURPOSES ONLY - NOT TO BE TREATED AS THE MASTER DRAWING**



— Victoria Park —

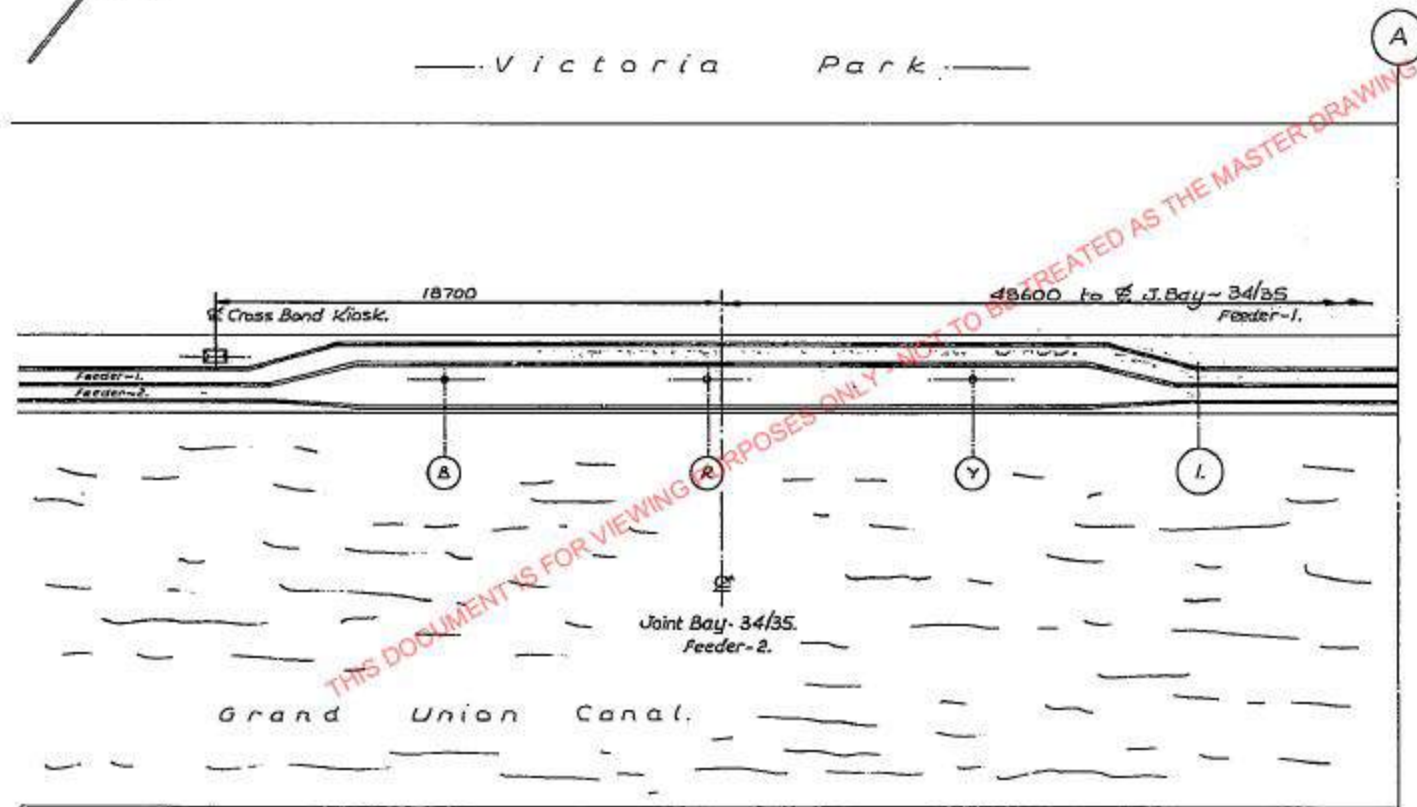

Grand Union Canal.

THIS DOCUMENT IS FOR VIEWING PURPOSES ONLY - NOT TO BE TREATED AS THE MASTER DRAWING

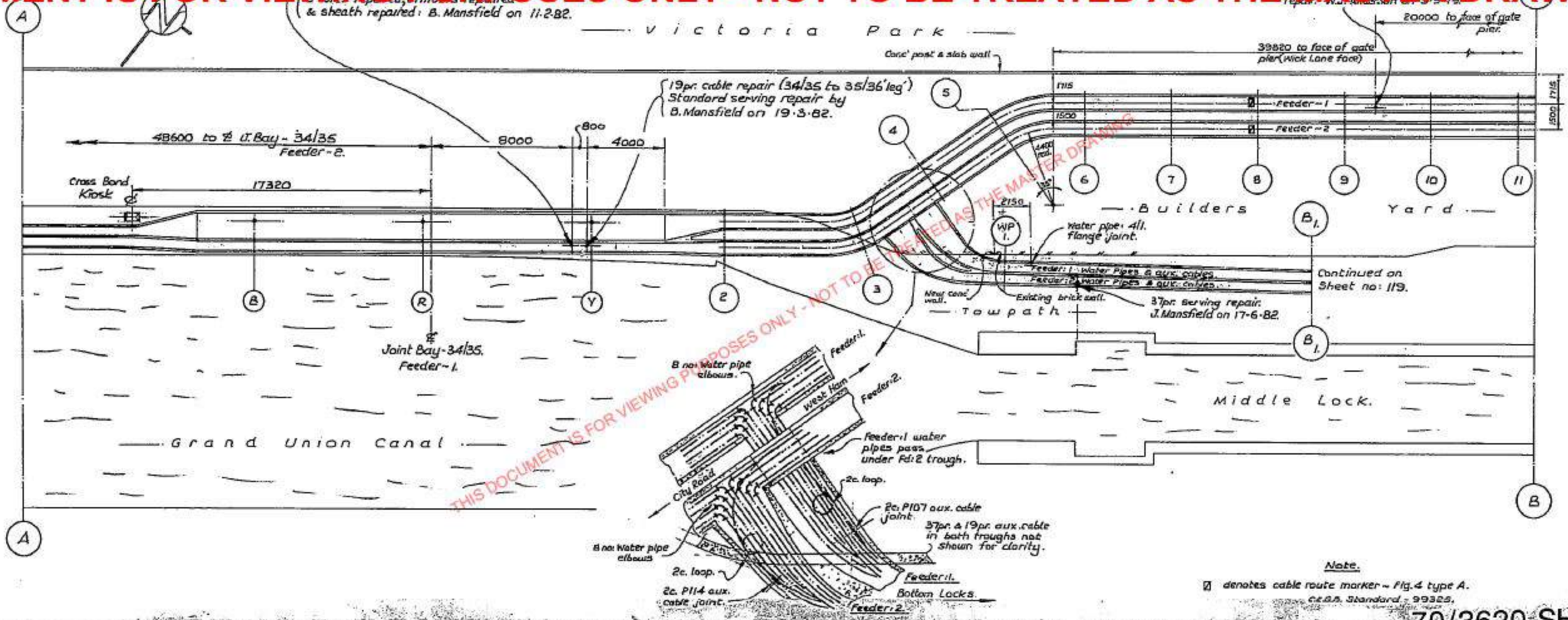

THIS DOCUMENT IS FOR VIEWING PURPOSES ONLY - NOT TO BE TREATED AS THE MASTER DRAWING

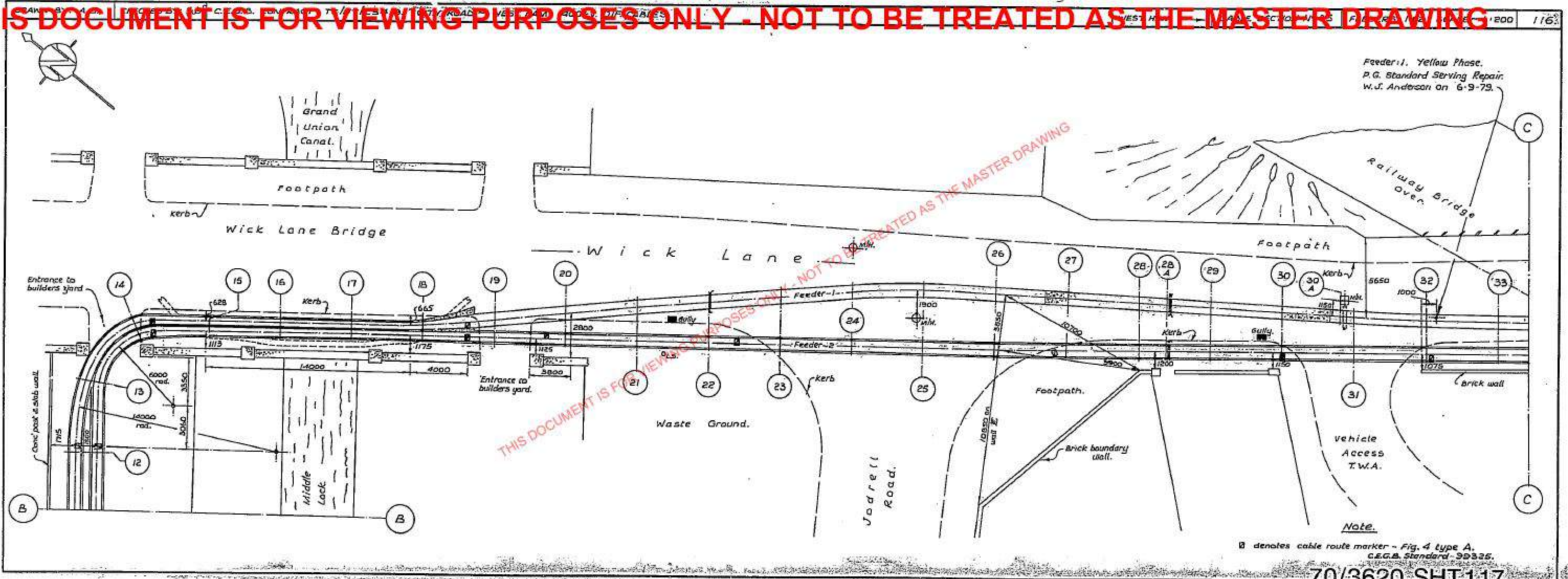

Feeder 1, Yellow Phase.  
P.G. Standard Servicing Repair.  
W.J. Anderson on 6-9-79.

THIS DOCUMENT IS FOR VIEWING PURPOSES ONLY - NOT TO BE TREATED AS THE MASTER DRAWING

Note.  
□ denotes cable route marker - Fig. 4 type A.  
C.E.G.B. Standard 99325.

70/3620-SHT 117

THIS DOCUMENT IS FOR VIEWING PURPOSES ONLY - NOT TO BE TREATED AS THE MASTER DRAWING





**THIS DOCUMENT IS FOR VIEWING PURPOSES ONLY - NOT TO BE TREATED AS THE MASTER DRAWING**

Feeder-1. Blue phase.  
P.G. Standard Servicing Repair.  
J. Anderson on 10-9-79.

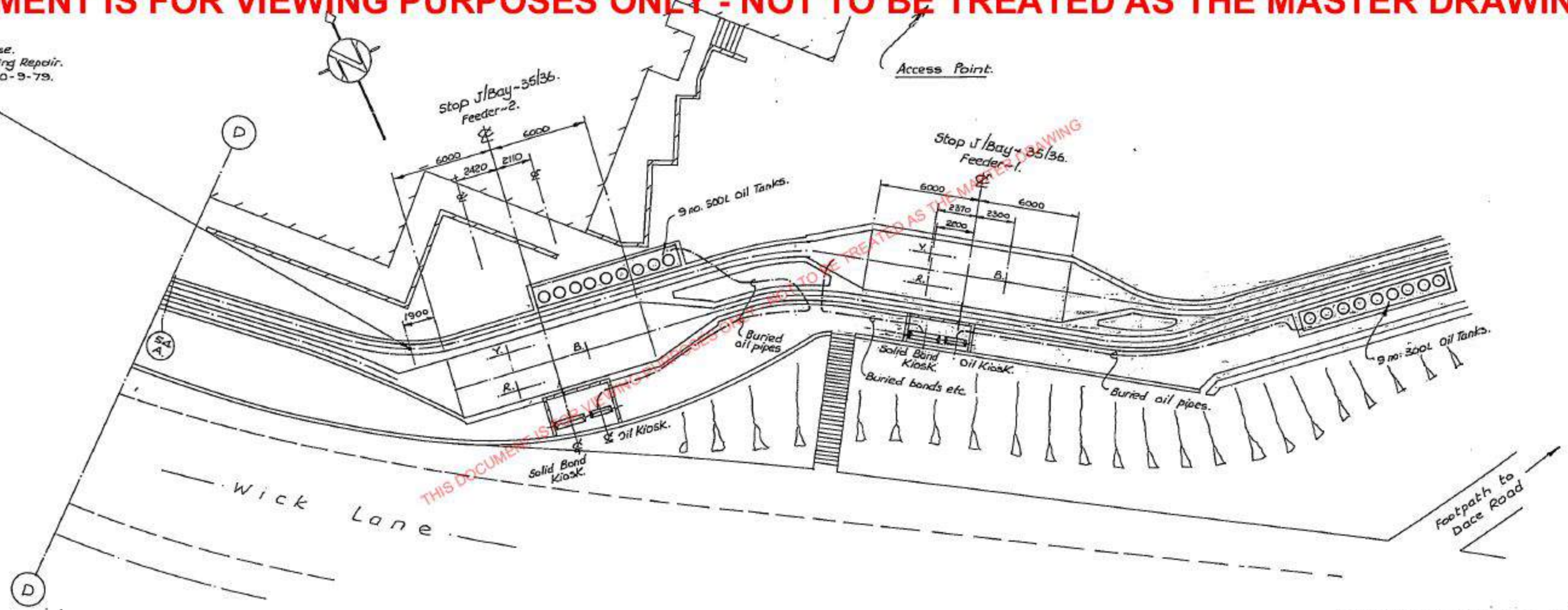

70/3620 SHT 1/19

**THIS DOCUMENT IS FOR VIEWING PURPOSES ONLY - NOT TO BE TREATED AS THE MASTER DRAWING**

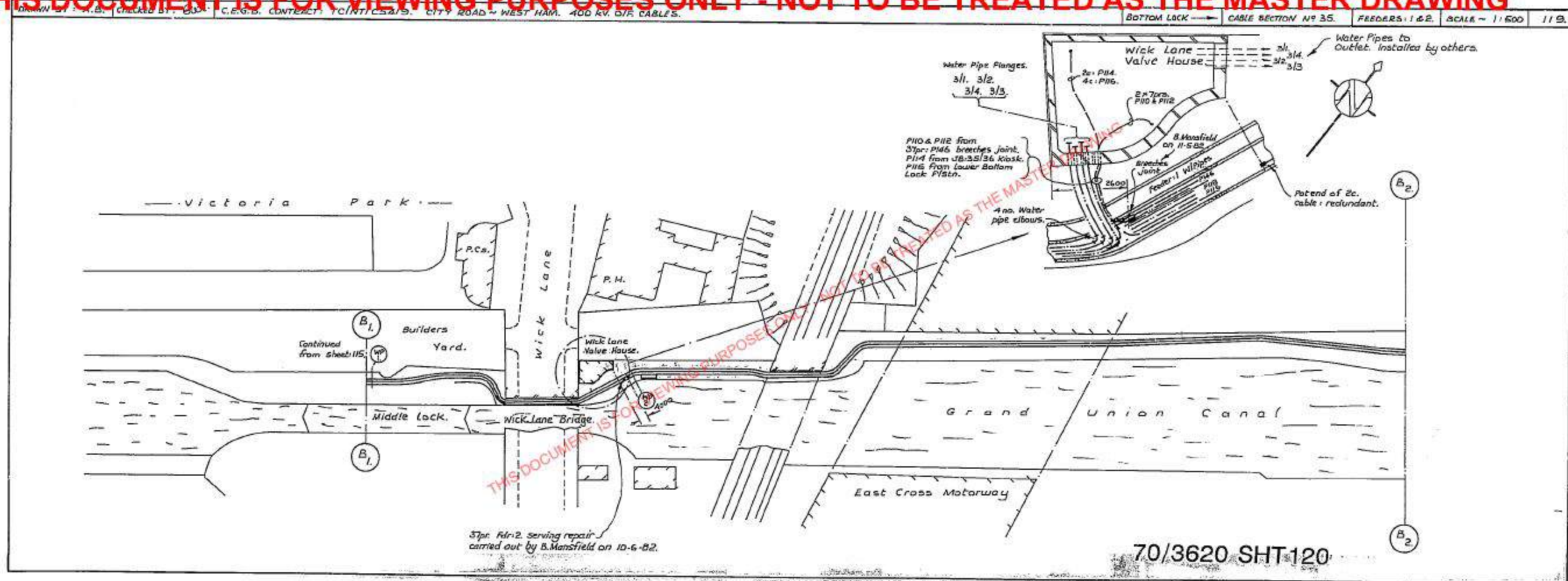

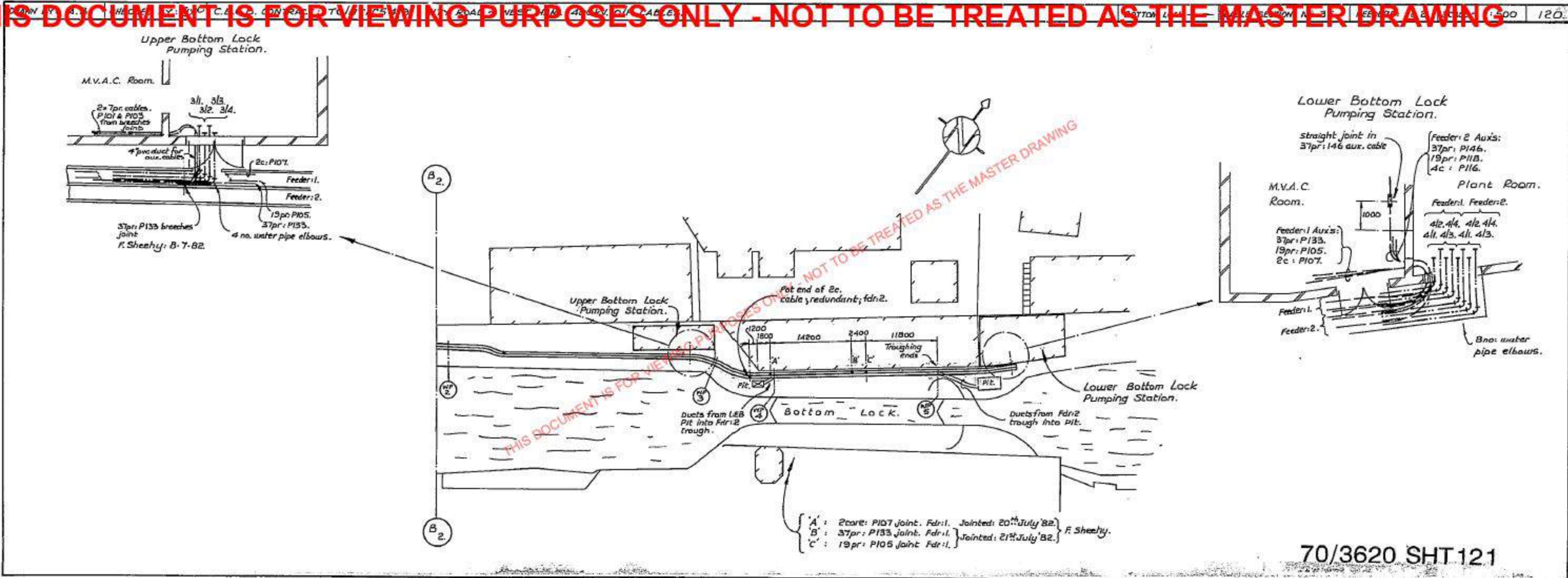

70/3620 SHT 121

**THIS DOCUMENT IS FOR VIEWING PURPOSES ONLY - NOT TO BE TREATED AS THE MASTER DRAWING**

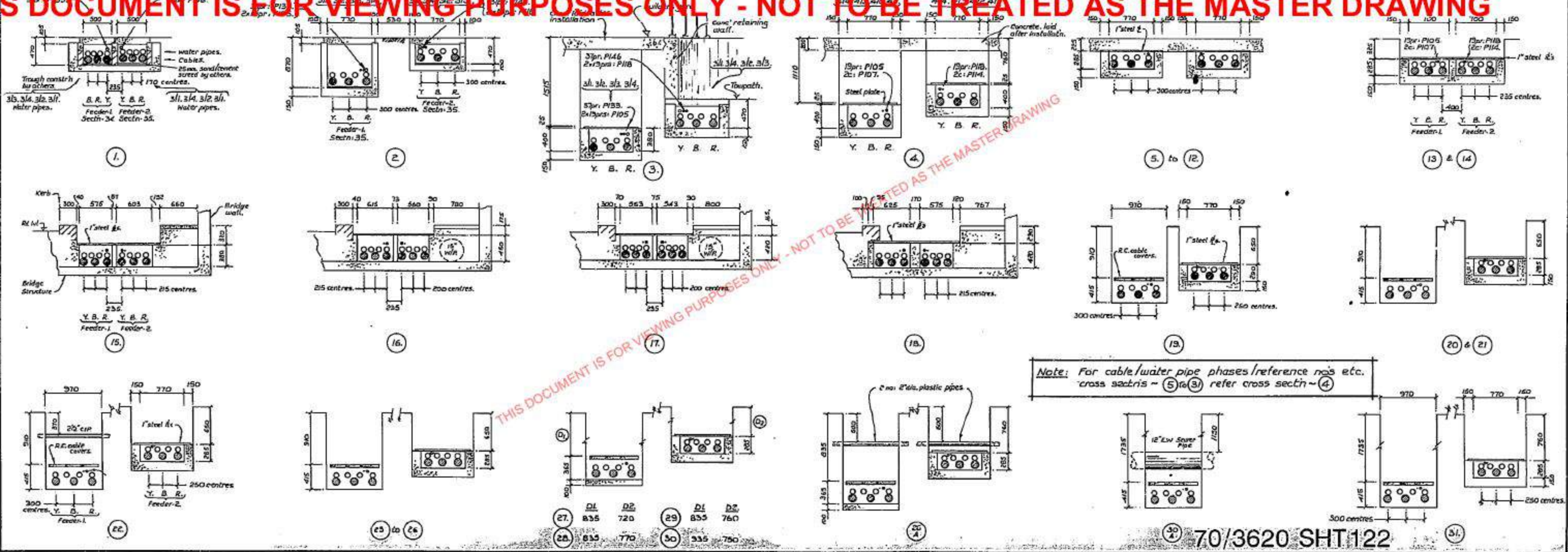

Note: For cable/water pipe phases/reference nos etc. cross sects ~ (5) (3) refer cross sectn ~ (4)

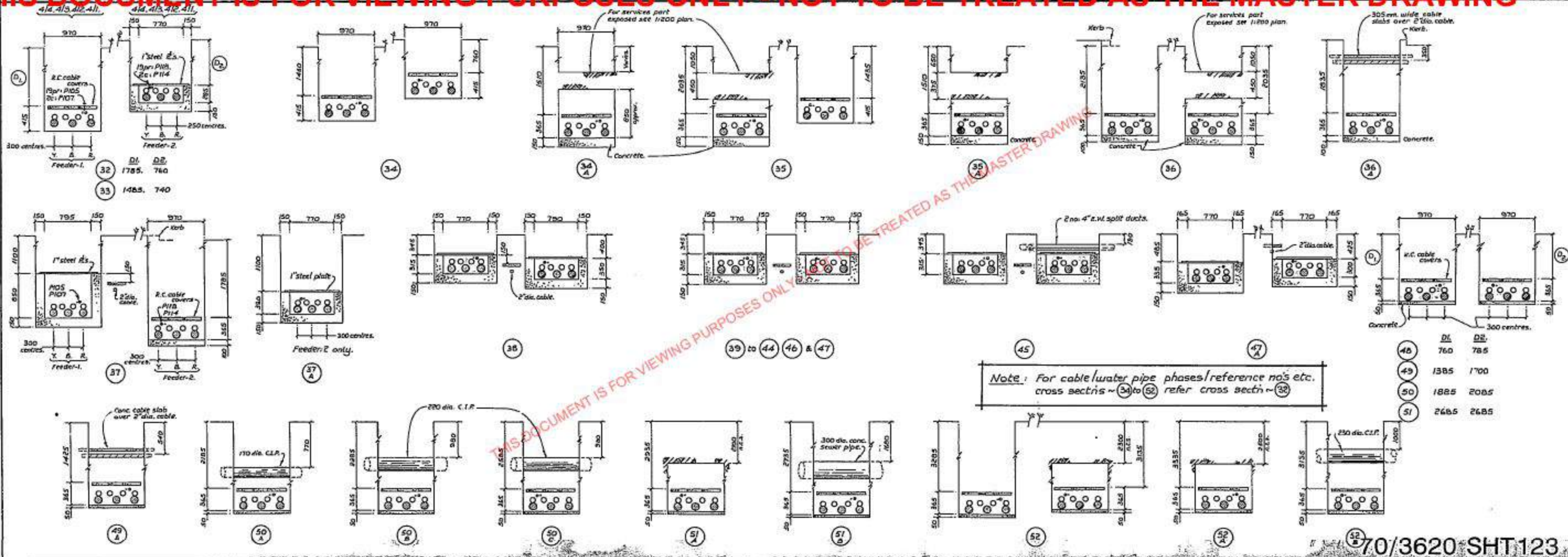

**THIS DOCUMENT IS FOR VIEWING PURPOSES ONLY - NOT TO BE TREATED AS THE MASTER DRAWING**

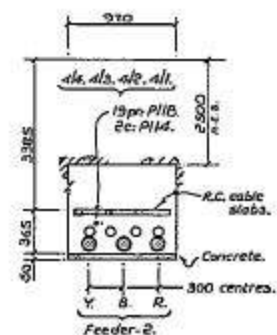

52

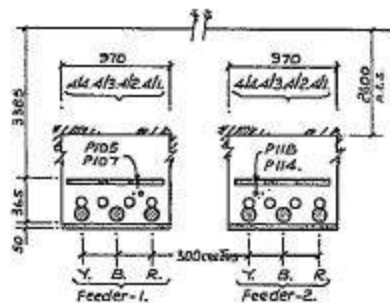

53

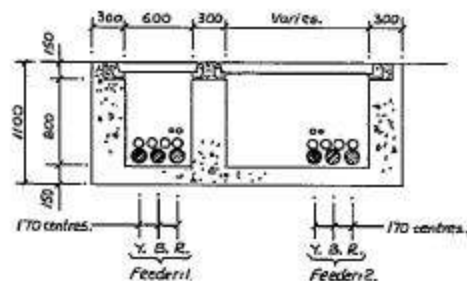

54

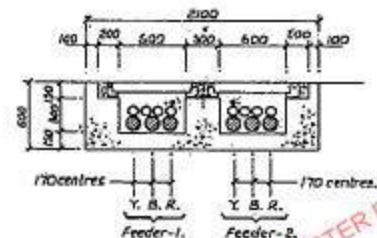

Cable / water pipe details

as cross section: 53

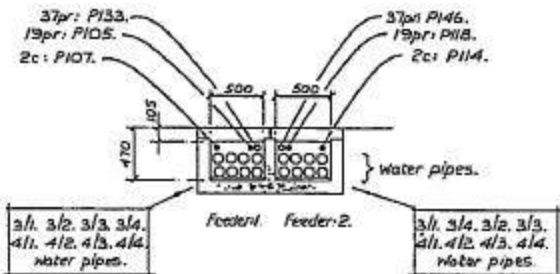

WP 1

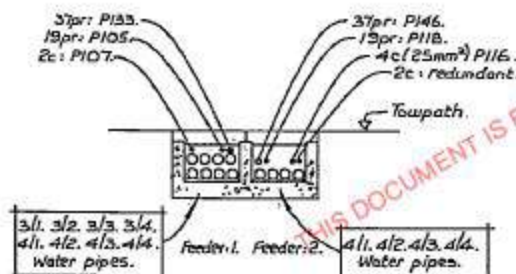

WP 2

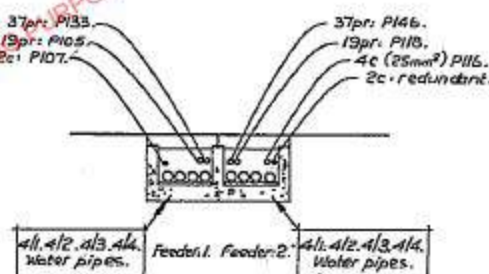

WP 3

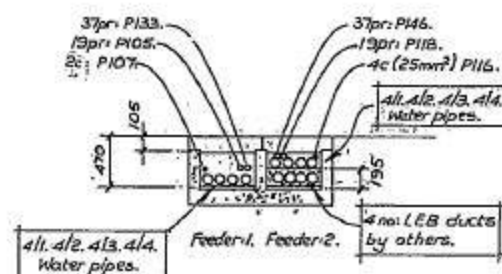

WP 4

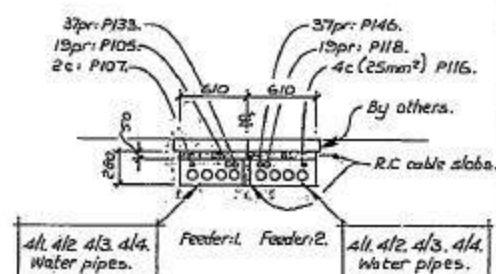

WP 5

Cable Troughing etc. for Water Pipe & Aux. Cables only from Builders Yard to Lower Bottom Lock.

**THIS DOCUMENT IS FOR VIEWING PURPOSES ONLY - NOT TO BE TREATED AS THE MASTER DRAWING**

DRAWN BY: A.B. CHECKED BY: G.W.C. C.E.G.B. CONTRACT: TC/NT/CS419. CITY ROAD - WEST HAM. 400 KV. O/F. CABLES.

WEST HAM → CABLE SECTION NO 36 FEEDERS 1 & 2 SCALE ~ 1:500 126.

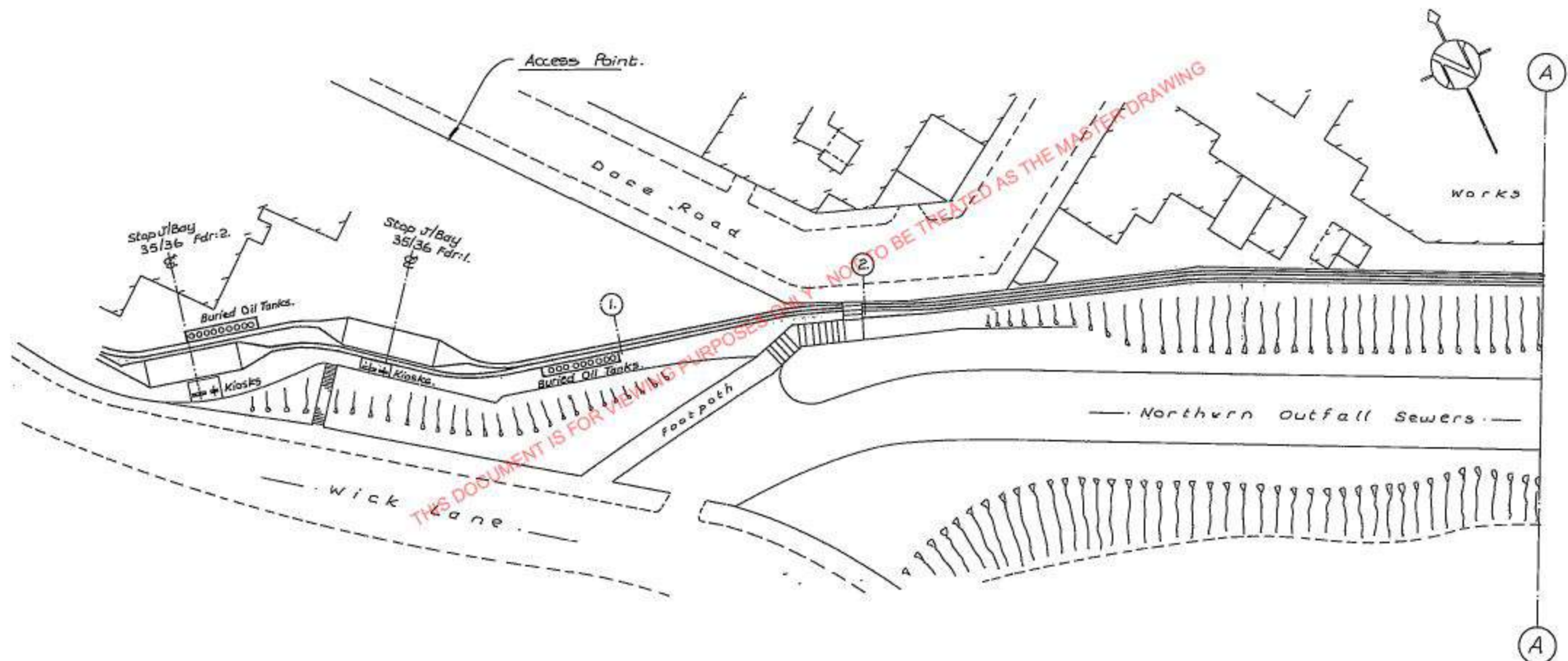

THIS DOCUMENT IS FOR VIEWING PURPOSES ONLY - NOT TO BE TREATED AS THE MASTER DRAWING

Based on C.E.G.B. dng. no: 16/16321.

70/3620 SHT 127

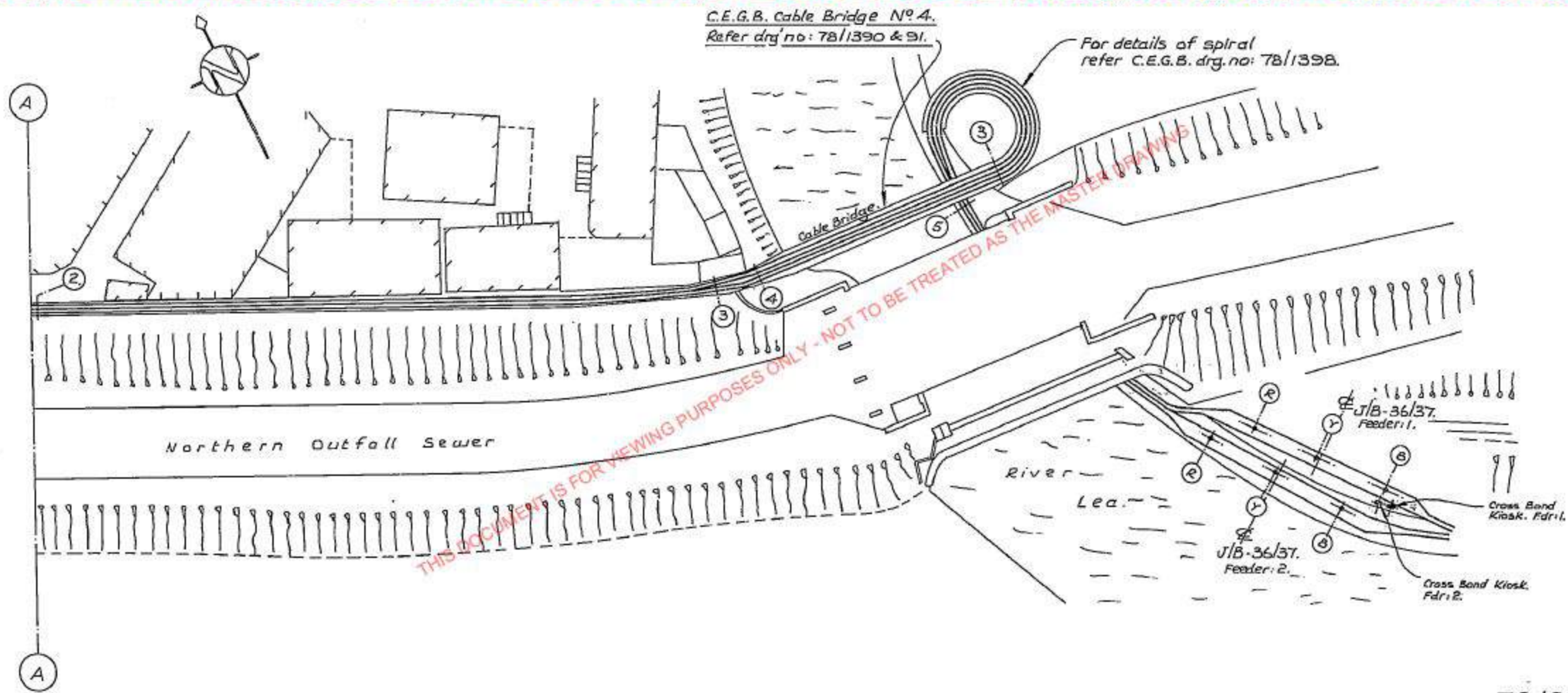



**THIS DOCUMENT IS FOR VIEWING PURPOSES ONLY - NOT TO BE TREATED AS THE MASTER DRAWING**

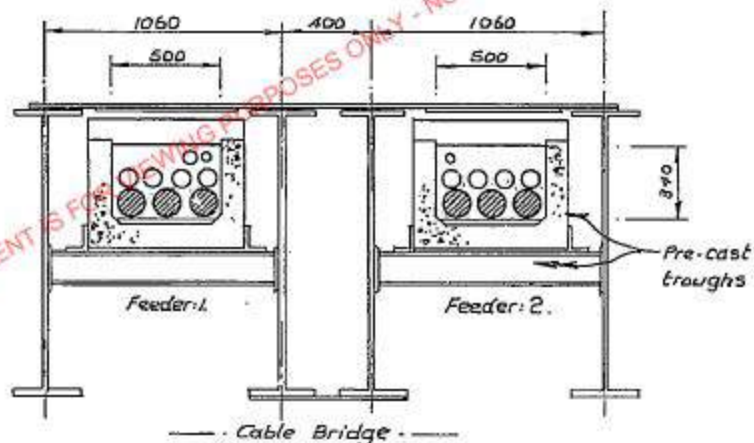
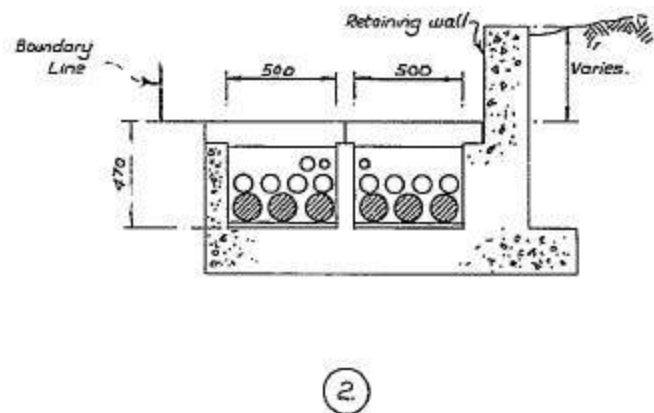
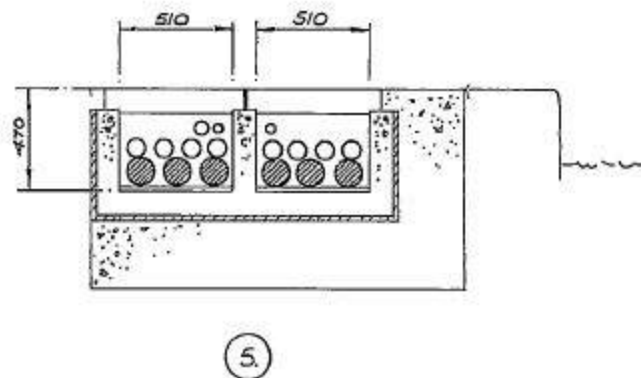
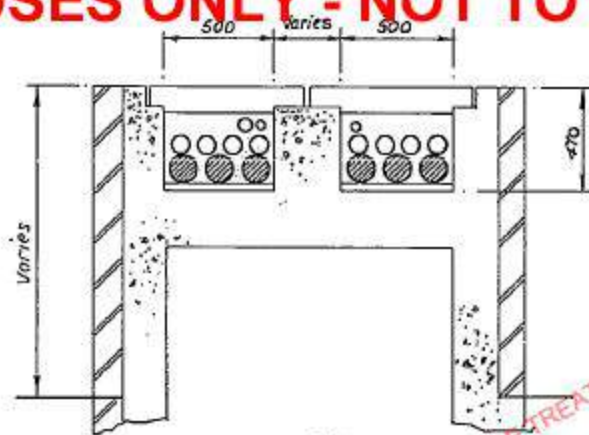
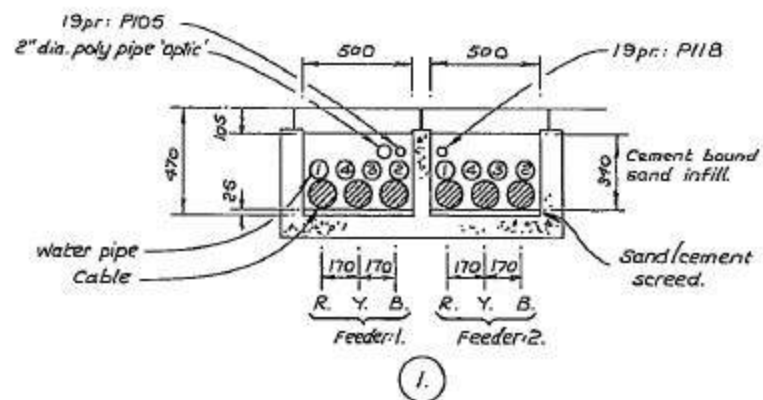

Note: For cable/water pipe phases/reference nos etc on cross sectns ② to ⑤ refer cross sectn: ①

Trough construction & base screed by others.

70/3620 SHT 129

Dear Sir/Madam,

Thank you for submitting your recent plant enquiry.

Based on the information provided, I can confirm that Energetics **does not** have any plant within the area(s) specified in your request.

Please be advised that it may take around 10 working days to process enquiries. In the unlikely event that you have been waiting longer than 10 working days, or require further assistance with outstanding enquiries, please call.

Please ensure all plant enquiries are sent to

Regards

**From:** utility.reports@emapsite.com [mailto:utility.reports@emapsite.com]

**Sent:** 11 March 2015 10:26

**To:** Plant Enquiries

**Subject:** Plant Location Request EMS00347 Site at GROWING CONCERNS GARDEN CENTRE, 2, WICK LANE, N/A, N/A, E3 2NA

**RE: GROWING CONCERNS GARDEN CENTRE, 2, WICK LANE, N/A, N/A, E3 2NA**

**Location: OSGB: 536905.000,184116.200**

**Our Reference: EMS00347**

## Utility Reports

---

**From:**  
**Sent:**  
**To:**  
**Subject:**  
**Attachments:**

24/03/2015

LinesearchbeforeUdig Ref: 6601423  
Your Ref: EMS00347

Dear Sir/Madam,

Further to your enquiry received on 24/03/2015 09:19:12 AM please find attached the ESP Utilities Group (ESP) response to your enquiry.

If your proposed work site was found to be in the vicinity of ESP plant, project drawing as laid extracts for these sites are enclosed (not to scale) for your information which show the approximate location of the ESP gas network close to the area of interest.

As your plans for the proposed work develop you are required to keep ESP regularly updated about the extent and nature of your proposed works in order for us to fully establish whether any additional precautionary or diversionary works are necessary to protect our gas network.

Arrangements can be set in place so that one of our representatives can meet on site (date to be agreed) and we will be happy to discuss the impact of your proposals on the gas network once we have received the details.

ESP are continually constructing new gas and electricity networks and this notification is valid for 90 days from the date of this letter. If your proposed works start after this period of time, please re-submit your linesearchbeforeUdig enquiry.

The attached files are in PDF format, to view them you will need Adobe Acrobat Reader(R). You can download it free of charge from <http://get.adobe.com/reader>

# Overview

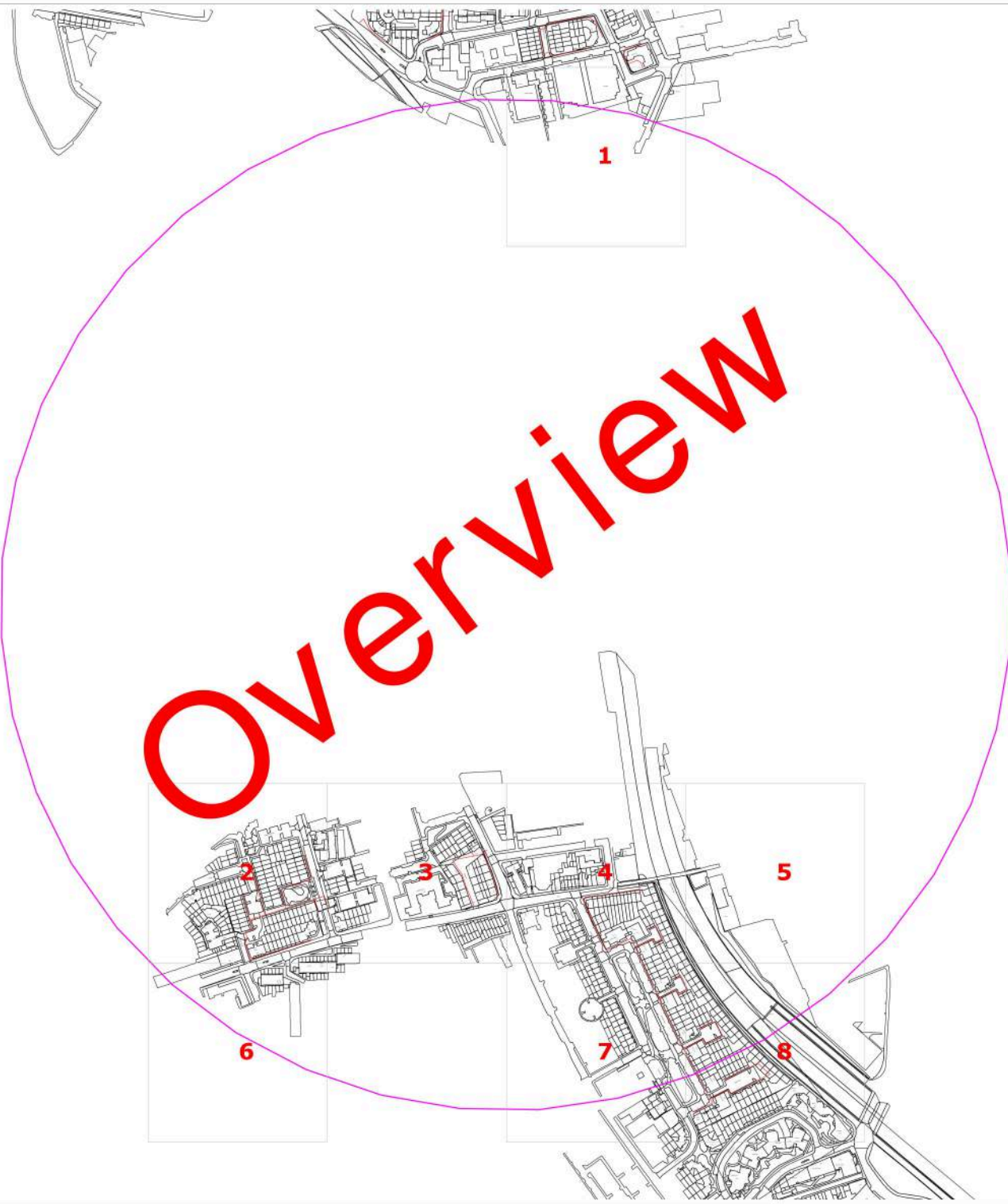



Date Requested: 24/03/2015  
 Requested by: Stephen Sawyer  
 Job Reference: 6601423

Company: Technics Group  
 Your Scheme/Reference: EMS00347





### Key for Mains & Service Pipework

-  Existing LP mains or services operating up to 75 millibar gauge
-  Existing MP mains or services operating between 75 millibar and 2 bar gauge
-  Existing IP mains or services operating between 2 bar and 7 bar gauge

Whilst ESP Utilities Group Ltd (ESP) try to ensure the asset information we provide is accurate, the information is provided Without Prejudice and ESP accept no liability for claims arising from any inaccuracy, omissions or errors contained in this response. The actual position of underground services must be verified and established on site before any mechanical plant is used. Authorities and contractors will be held liable for the full cost of repairs to ESP apparatus and all claims made against them by Third parties as a result of any interference or damage.

REPRODUCED FROM THE ORDNANCE SURVEY MAP WITH THE SANCTION OF THE CONTROLLER OF HER MAJESTY'S STATIONARY OFFICE © CROWN COPYRIGHT RESERVED.  
 THIS DRAWING IS THE COPYRIGHT OF ES PIPELINES LIMITED AND MAY NOT BE REPRODUCED WITHOUT WRITTEN CONSENT ©

Dig Sites:  
 Area  Line   
 Approx scale on A4 paper: 1:1000  
 (excluding Overview map)



Date Requested: 24/03/2015  
 Requested by: Stephen Sawyer  
 Job Reference: 6601423

Company: Technics Group  
 Your Scheme/Reference: EMS00347

**Key for Mains & Service Pipework**



Existing LP mains or services operating up to 75 millibar gauge



Existing MP mains or services operating between 75 millibar and 2 bar gauge



Existing IP mains or services operating between 2 bar and 7 bar gauge



Whilst ESP Utilities Group Ltd (ESP) try to ensure the asset information we provide is accurate, the information is provided Without Prejudice and ESP accept no liability for claims arising from any inaccuracy, omissions or errors contained in this response. The actual position of underground services must be verified and established on site before any mechanical plant is used. Authorities and contractors will be held liable for the full cost of repairs to ESP apparatus and all claims made against them by Third parties as a result of any interference or damage.

**REPRODUCED FROM THE ORDNANCE SURVEY MAP WITH THE SANCTION OF THE CONTROLLER OF HER MAJESTY'S STATIONARY OFFICE © CROWN COPYRIGHT RESERVED.**  
**THIS DRAWING IS THE COPYRIGHT OF ES PIPELINES LIMITED AND MAY NOT BE REPRODUCED WITHOUT WRITTEN CONSENT ©**

Dig Sites:

Area  Line 

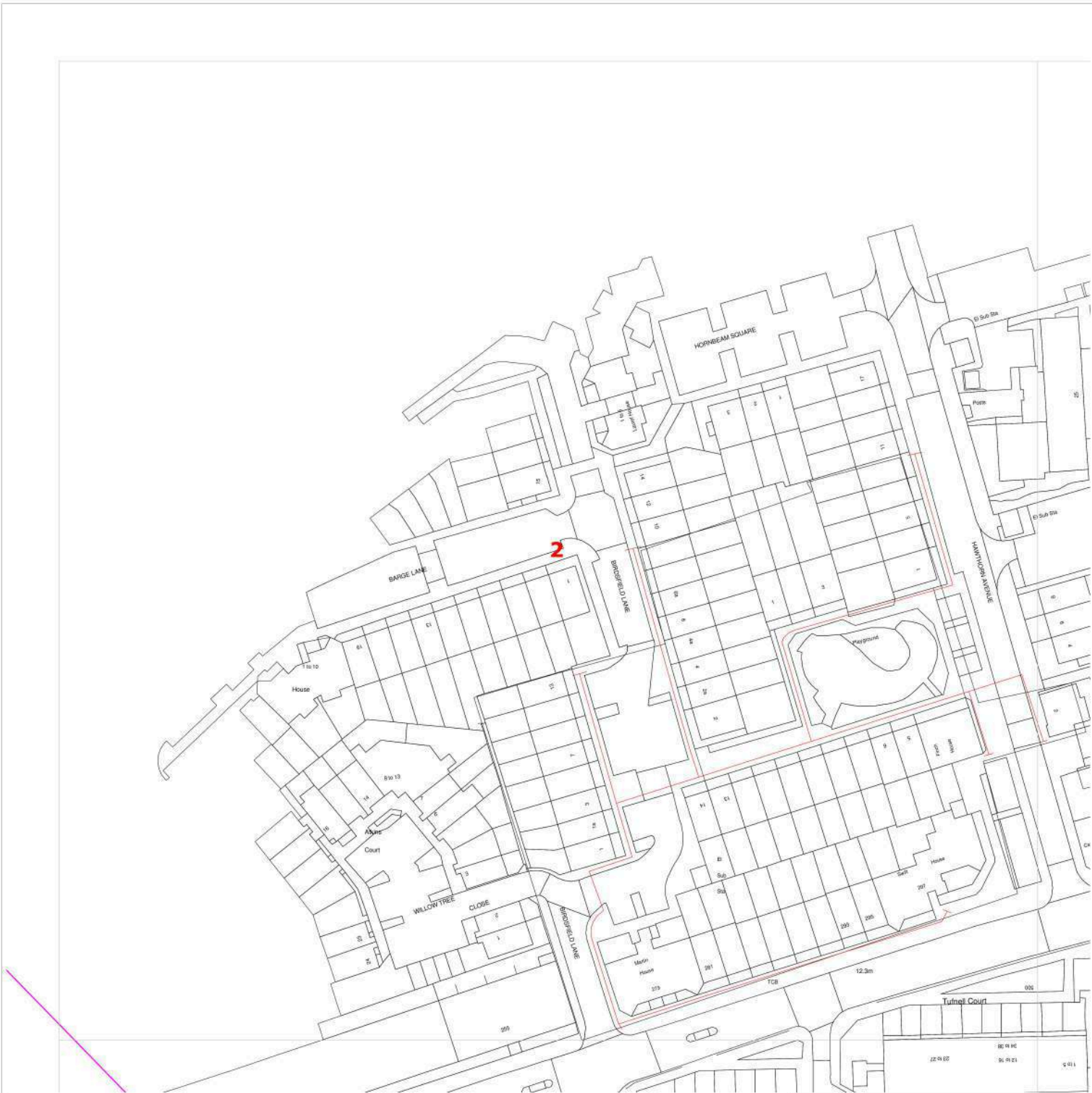

Approx scale on A4 paper: 1:1000  
 (excluding Overview map)



Date Requested: 24/03/2015  
 Requested by: Stephen Sawyer  
 Job Reference: 6601423

Company: Technics Group  
 Your Scheme/Reference: EMS00347



**Key for Mains & Service Pipework**

-  Existing LP mains or services operating up to 75 millibar gauge
-  Existing MP mains or services operating between 75 millibar and 2 bar gauge
-  Existing IP mains or services operating between 2 bar and 7 bar gauge



Whilst ESP Utilities Group Ltd (ESP) try to ensure the asset information we provide is accurate, the information is provided Without Prejudice and ESP accept no liability for claims arising from any inaccuracy, omissions or errors contained in this response. The actual position of underground services must be verified and established on site before any mechanical plant is used. Authorities and contractors will be held liable for the full cost of repairs to ESP apparatus and all claims made against them by Third parties as a result of any interference or damage.

REPRODUCED FROM THE ORDNANCE SURVEY MAP WITH THE SANCTION OF THE CONTROLLER OF HER MAJESTY'S STATIONARY OFFICE © CROWN COPYRIGHT RESERVED.  
 THIS DRAWING IS THE COPYRIGHT OF ES PIPELINES LIMITED AND MAY NOT BE REPRODUCED WITHOUT WRITTEN CONSENT ©

Dig Sites:  
 Area  Line   
 Approx scale on A4 paper: 1:1000  
 (excluding Overview map)



Date Requested: 24/03/2015  
 Requested by: Stephen Sawyer  
 Job Reference: 6601423

Company: Technics Group  
 Your Scheme/Reference: EMS00347

**Key for Mains & Service Pipework**



Existing LP mains or services operating up to 75 millibar gauge

Existing MP mains or services operating between 75 millibar and 2 bar gauge

Existing IP mains or services operating between 2 bar and 7 bar gauge



Whilst ESP Utilities Group Ltd (ESP) try to ensure the asset information we provide is accurate, the information is provided Without Prejudice and ESP accept no liability for claims arising from any inaccuracy, omissions or errors contained in this response. The actual position of underground services must be verified and established on site before any mechanical plant is used. Authorities and contractors will be held liable for the full cost of repairs to ESP apparatus and all claims made against them by Third parties as a result of any interference or damage.

Dig Sites:  
 Area Line   
 Approx scale on A4 paper: 1:1000 (excluding Overview map)

**REPRODUCED FROM THE ORDNANCE SURVEY MAP WITH THE SANCTION OF THE CONTROLLER OF HER MAJESTY'S STATIONARY OFFICE © CROWN COPYRIGHT RESERVED.**  
**THIS DRAWING IS THE COPYRIGHT OF ES PIPELINES LIMITED AND MAY NOT BE REPRODUCED WITHOUT WRITTEN CONSENT ©**



Date Requested: 24/03/2015  
 Requested by: Stephen Sawyer  
 Job Reference: 6601423

Company: Technics Group  
 Your Scheme/Reference: EMS00347

**Key for Mains & Service Pipework**



Existing LP mains or services operating up to 75 millibar gauge



Existing MP mains or services operating between 75 millibar and 2 bar gauge



Existing IP mains or services operating between 2 bar and 7 bar gauge



Whilst ESP Utilities Group Ltd (ESP) try to ensure the asset information we provide is accurate, the information is provided Without Prejudice and ESP accept no liability for claims arising from any inaccuracy, omissions or errors contained in this response. The actual position of underground services must be verified and established on site before any mechanical plant is used. Authorities and contractors will be held liable for the full cost of repairs to ESP apparatus and all claims made against them by Third parties as a result of any interference or damage.

REPRODUCED FROM THE ORDNANCE SURVEY MAP WITH THE SANCTION OF THE CONTROLLER OF HER MAJESTY'S STATIONARY OFFICE © CROWN COPYRIGHT RESERVED.  
 THIS DRAWING IS THE COPYRIGHT OF ES PIPELINES LIMITED AND MAY NOT BE REPRODUCED WITHOUT WRITTEN CONSENT ©

Dig Sites:  
 Area Line   
 Approx scale on A4 paper: 1:1000  
 (excluding Overview map)





Date Requested: 24/03/2015  
 Requested by: Stephen Sawyer  
 Job Reference: 6601423

Company: Technics Group  
 Your Scheme/Reference: EMS00347



**Key for Mains & Service Pipework**



Existing LP mains or services operating up to 75 millibar gauge





Existing MP mains or services operating between 75 millibar and 2 bar gauge



Existing IP mains or services operating between 2 bar and 7 bar gauge

Whilst ESP Utilities Group Ltd (ESP) try to ensure the asset information we provide is accurate, the information is provided Without Prejudice and ESP accept no liability for claims arising from any inaccuracy, omissions or errors contained in this response. The actual position of underground services must be verified and established on site before any mechanical plant is used. Authorities and contractors will be held liable for the full cost of repairs to ESP apparatus and all claims made against them by Third parties as a result of any interference or damage.

**REPRODUCED FROM THE ORDNANCE SURVEY MAP WITH THE SANCTION OF THE CONTROLLER OF HER MAJESTY'S STATIONARY OFFICE © CROWN COPYRIGHT RESERVED.**  
**THIS DRAWING IS THE COPYRIGHT OF ES PIPELINES LIMITED AND MAY NOT BE REPRODUCED WITHOUT WRITTEN CONSENT ©**

Dig Sites:  
 Area  Line   
 Approx scale on A4 paper: 1:1000  
 (excluding Overview map)

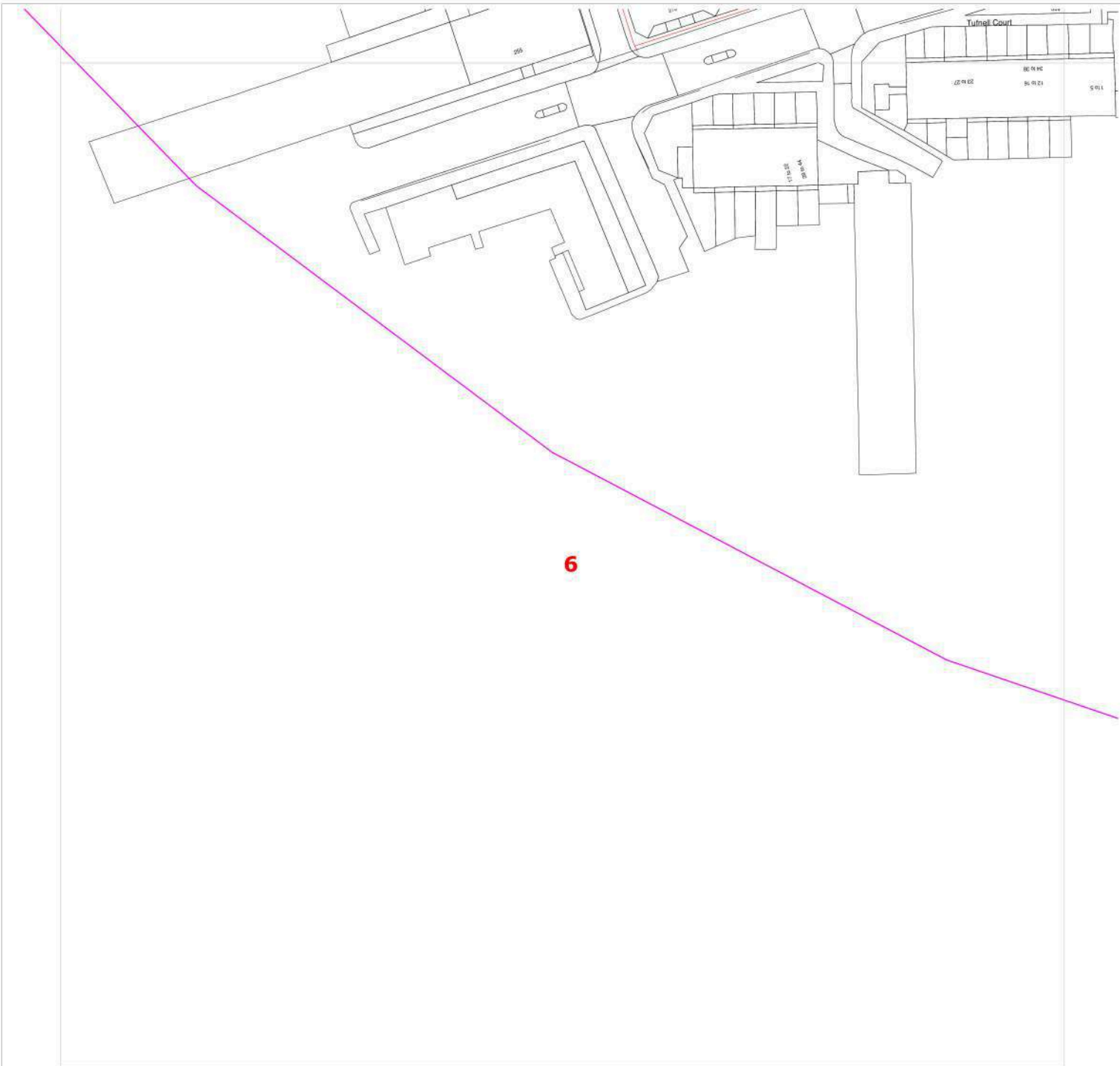

Date Requested: 24/03/2015  
 Requested by: Stephen Sawyer  
 Job Reference: 6601423

Company: Technics Group  
 Your Scheme/Reference: EMS00347



**Key for Mains & Service Pipework**

	Existing LP mains or services operating up to 75 millibar gauge
	Existing MP mains or services operating between 75 millibar and 2 bar gauge
	Existing IP mains or services operating between 2 bar and 7 bar gauge

Whilst ESP Utilities Group Ltd (ESP) try to ensure the asset information we provide is accurate, the information is provided Without Prejudice and ESP accept no liability for claims arising from any inaccuracy, omissions or errors contained in this response. The actual position of underground services must be verified and established on site before any mechanical plant is used. Authorities and contractors will be held liable for the full cost of repairs to ESP apparatus and all claims made against them by Third parties as a result of any interference or damage.

**REPRODUCED FROM THE ORDNANCE SURVEY MAP WITH THE SANCTION OF THE CONTROLLER OF HER MAJESTY'S STATIONARY OFFICE © CROWN COPYRIGHT RESERVED.**  
**THIS DRAWING IS THE COPYRIGHT OF ES PIPELINES LIMITED AND MAY NOT BE REPRODUCED WITHOUT WRITTEN CONSENT ©**

Dig Sites:  
 Area Line   
 Approx scale on A4 paper: 1:1000  
 (excluding Overview map)

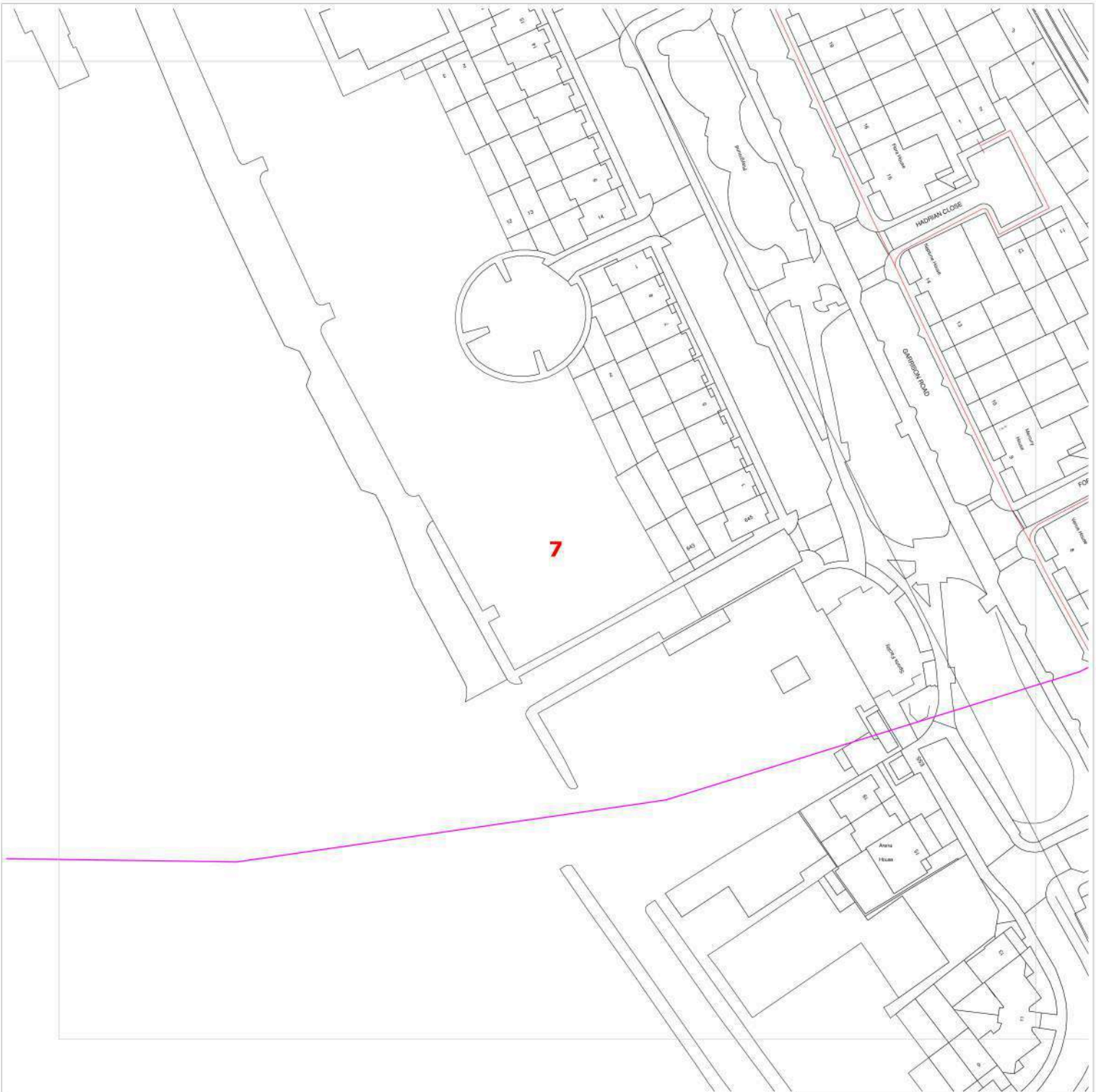

Date Requested: 24/03/2015  
 Requested by: Stephen Sawyer  
 Job Reference: 6601423

Company: Technics Group  
 Your Scheme/Reference: EMS00347



**Key for Mains & Service Pipework**



Existing LP mains or services operating up to 75 millibar gauge

Existing MP mains or services operating between 75 millibar and 2 bar gauge

Existing IP mains or services operating between 2 bar and 7 bar gauge

Whilst ESP Utilities Group Ltd (ESP) try to ensure the asset information we provide is accurate, the information is provided Without Prejudice and ESP accept no liability for claims arising from any inaccuracy, omissions or errors contained in this response. The actual position of underground services must be verified and established on site before any mechanical plant is used. Authorities and contractors will be held liable for the full cost of repairs to ESP apparatus and all claims made against them by Third parties as a result of any interference or damage.

**REPRODUCED FROM THE ORDNANCE SURVEY MAP WITH THE SANCTION OF THE CONTROLLER OF HER MAJESTY'S STATIONARY OFFICE © CROWN COPYRIGHT RESERVED.**  
**THIS DRAWING IS THE COPYRIGHT OF ES PIPELINES LIMITED AND MAY NOT BE REPRODUCED WITHOUT WRITTEN CONSENT ©**

Dig Sites:  
 Area Line   
 Approx scale on A4 paper: 1:1000  
 (excluding Overview map)

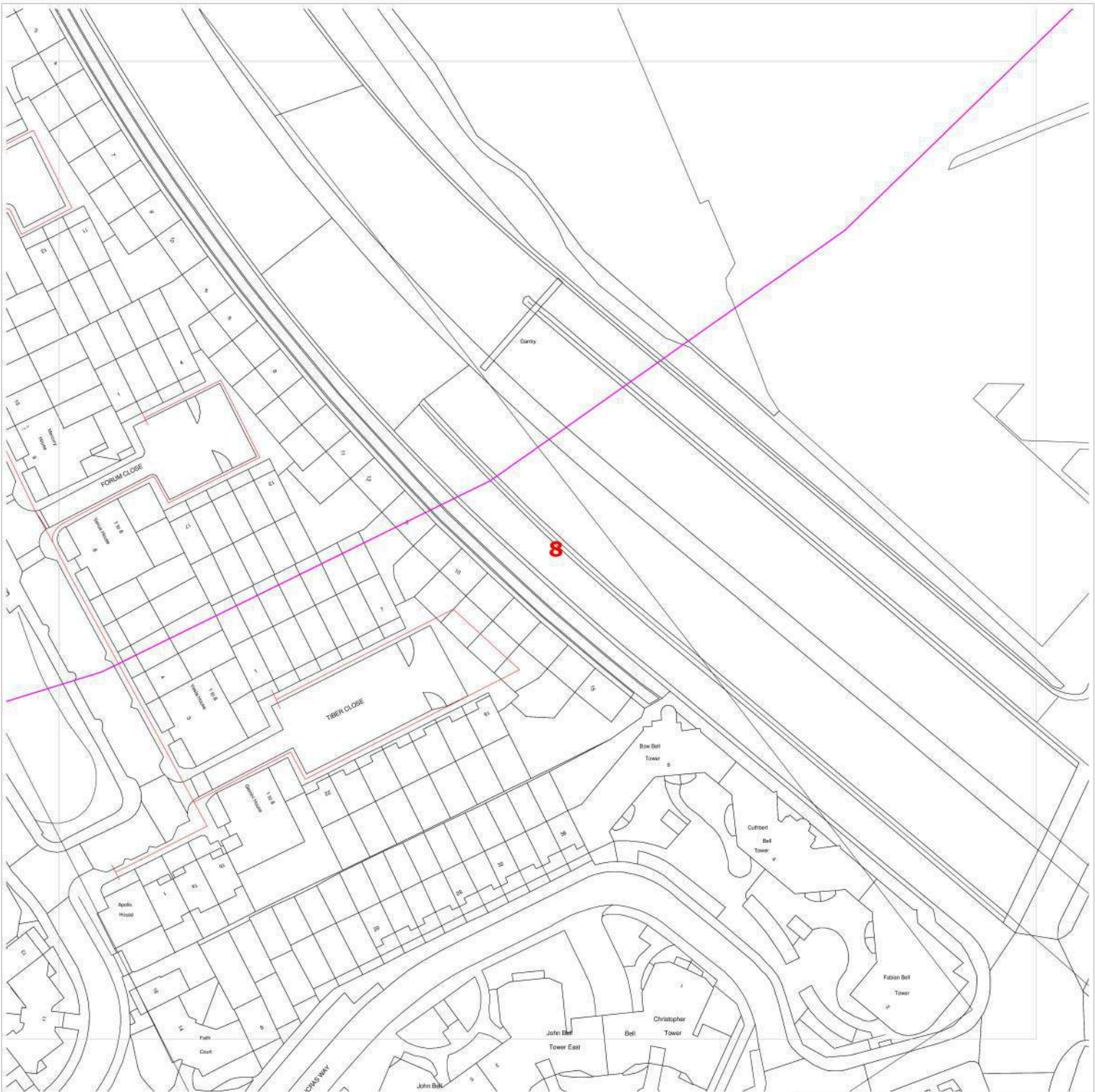

Date Requested: 24/03/2015  
 Requested by: Stephen Sawyer  
 Job Reference: 6601423

Company: Technics Group  
 Your Scheme/Reference: EMS00347

**Key for Mains & Service Pipework**



Existing LP mains or services operating up to 75 millibar gauge



Existing MP mains or services operating between 75 millibar and 2 bar gauge





Existing IP mains or services operating between 2 bar and 7 bar gauge



Whilst ESP Utilities Group Ltd (ESP) try to ensure the asset information we provide is accurate, the information is provided Without Prejudice and ESP accept no liability for claims arising from any inaccuracy, omissions or errors contained in this response. The actual position of underground services must be verified and established on site before any mechanical plant is used. Authorities and contractors will be held liable for the full cost of repairs to ESP apparatus and all claims made against them by Third parties as a result of any interference or damage.

**REPRODUCED FROM THE ORDNANCE SURVEY MAP WITH THE SANCTION OF THE CONTROLLER OF HER MAJESTY'S STATIONARY OFFICE © CROWN COPYRIGHT RESERVED.**  
**THIS DRAWING IS THE COPYRIGHT OF ES PIPELINES LIMITED AND MAY NOT BE REPRODUCED WITHOUT WRITTEN CONSENT ©**

Dig Sites:  
 Area  Line   
 Approx scale on A4 paper: 1:1000  
 (excluding Overview map)

---

**PRECAUTIONS TO BE TAKEN WHEN CARRYING OUT WORK IN THE VICINITY OF UNDERGROUND GAS PIPES**

**ADVICE TO SITE PERSONNEL**

**MANAGEMENT NOTE**

Please ensure that a copy of this note is read by your site management and to your site operatives.

Early consultation with ESP Utilities Group prior to excavation is recommended to obtain the location of plant and precautions to be taken when working nearby.

This Guidance Note should be read in conjunction with the Health and Safety Executive guidance HSG47 "Avoiding danger from underground services".

---

**Introduction**

Damage to ESP Utilities Group's plant can result in uncontrolled gas escapes which may be dangerous. In addition these occurrences can cause expense, disruption of work and inconvenience to the public.

Various materials are used for gas mains and services. Cast Iron, Ductile Iron, Steel and Plastic pipes are the most widely found. Modern Plastic pipes are either bright yellow or orange in colour.

Cast Iron and Ductile Iron water pipes are very similar in appearance to Cast Iron and Ductile Iron gas pipes and if any Cast Iron or Ductile Iron pipe is uncovered, it should be treated as a gas pipe. ESP Utilities Group do not own any metallic gas pipes but their gas network infrastructures may be connected to Cast Iron, Ductile Iron or Steel pipes owned by Transco.

The following general precautions apply to Intermediate Pressure (2-7barg MOP), Medium Pressure (75mbarg-2barg MOP), Low Pressure (up to 75mbarg MOP) and other gas mains and services likely to be encountered in general site works and are referred to within this document as 'pipes'.

**Locating Gas Pipes**

It should be assumed when working in urban and residential areas that gas mains and services are likely to be present. On request, ESP Utilities Group will give approximate locations of pipes derived from their records. The records do not normally show the position of service pipes but their probable line can be deducted from the gas meter position. ESP Utilities Group's staff will be pleased to assist in the location of gas plant and provide advice on any precautions that may be required. The records and advice are given in good faith but cannot be guaranteed until hand excavation has taken place. Proprietary pipe and cable locators are available although generally these will not locate plastic pipes.

**Safe working Practices**

**To achieve safe working conditions adjacent to gas plant the following must be observed:**

Observe any specific request made by ESP Utilities Group's staff.

Gas pipes must be located by hand digging before mechanical excavation. Once a gas pipe has been located, mechanical excavation must proceed **with care**. A mechanical excavator must not in any case be used within 0.5 metre of a gas pipe and greater safety distances may be advised by ESP Utilities Group depending on the mains maximum operating pressure (MOP).

Where heavy plant may have to cross the line of a gas pipe during construction work, the number of crossing points should be kept to a minimum. Crossing points should be clearly indicated and crossings at other places along the line of the pipe should be prevented.

Where the pipe is not adequately protected by an existing road, crossing points should be suitably reinforced with sleepers, steel plates or a specially constructed reinforced concrete raft as necessary. ESP Utilities Group staff will advise on the type of reinforcement necessary.

No explosives should be used within 30 metres of any gas pipe without prior consultation with ESP Utilities Group.

**ESP Utilities Group must be consulted prior to carrying out excavation work within 10 metres of any above ground gas installation.**

Where it is proposed to carry out piling or boring within 15 metres of any gas pipe, ESP Utilities Group should be consulted prior to the commencement of the works.

Access to gas plant must be maintained at all times during on site works.

---

### **Proximity of Other Plant**

A minimum clearance of 300 millimetres (mm) should be allowed between any plant being installed and an existing gas main to facilitate repair, whether the adjacent plant be parallel to or crossing the gas pipe. No apparatus should be laid over and along the line of a gas pipe irrespective of clearance.

No manhole or chambers shall be built over or around a gas pipe and no work should be carried out which results in a reduction of cover or protection over a pipe, without consultation with ESP Utilities Group.

### **Support and Backfill**

Where excavation of trenches adjacent to any pipe affects its support, the pipe must be supported to the satisfaction of ESP Utilities Group and must not be used as an anchor or support in any way. In some cases, it may be necessary to divert the gas pipe before work commences.

Where a trench is excavated crossing or parallel to the line of the gas pipe, the backfill should be adequately compacted, particularly beneath the pipe, to prevent any settlement which could subsequently cause damage to the pipe.

In special cases it may be necessary to provide permanent support to the gas pipe, before backfilling and reinstatement is carried out. Backfill material adjacent to gas plant must be selected fine material or sand, containing no stones, bricks or lumps of concrete, etc., placed to a minimum depth of 150mm around the pipes and well compacted by hand. No power compaction should take place until 300 mm of selected fine fill has been suitably compacted.

If the road construction is in close proximity to the top of the gas pipe, a "cushion" of selected fine material such as sand must be used to prevent the traffic shock being transmitted to the gas pipe. The road construction depth must not be reduced without permission from the local Highway Authority.

No concrete or other hard material must be placed or left under or adjacent to any Cast Iron pipe as this may cause fracture of the pipe at a later date.

Concrete backfill should not be used closer than 300 mm to the pipe.

### **Damage to Coating**

Where a gas pipe is coated with special wrapping and this is damaged, even to a minor extent ESP Utilities Group must be notified so that repairs can be made to prevent future corrosion and subsequent leakage.

### **Welding or "Hot Works"**

When welding or other "hot works" involving naked flames are to be carried out in close proximity to gas plant and the presence of gas is suspected, ESP Utilities Group must be contacted before work commences to check the atmosphere. Even when a gas free atmosphere exists care must be taken when carrying out hot works in close proximity to gas plant in order to ensure that no damage occurs.

Particular care must be taken to avoid damage by heat or naked flame to plastic gas pipes or to the protective coating on other gas pipes.

### **Leakage from Gas Mains or Services**

If damage or leakage is caused or an escape of gas is smelt or suspected the following action should be taken at once:

- ❖ Remove all personnel from the immediate vicinity of the escape;
- ❖ Contact Transco's National Gas Escape Call Centre, on: **0800 111 999**;
- ❖ Prevent any approach by the public, prohibit smoking, extinguish all naked flames or other source of ignition for at least 15 metres from the leakage;
- ❖ Assist gas personnel, Police or Fire Service as requested.

## Utility Reports

---

**From:**

**Sent:**

**To:**

**Subject:**

**Attachments:**

### **Warning: GTC Apparatus Exists in This Area**

**Our Plant Enquiry Service Ref: 97606**

**Your Enquiry Ref: EMS00347**

Dear Utility,

Thank you for your enquiry concerning apparatus in the vicinity of your proposed work. For your records, the search area is shown in the attached map.

Please click on the links below to download copies of the relevant utility asset drawings locating our assets in the area which you identified. These drawings are grouped by our relevant network reference, should you need to contact us regarding any of our networks please quote this reference. Links to files will remain live for 10 days. If you do not download these files within this period you will need to submit a new enquiry – this will ensure you have an up-to-date copy of our asset records.

**PLEASE NOTE:** Where drawings are large, these have been provided in smaller segments. A drawing index is provided as the first file listed for each network reference (example of a network reference: N1234567) shown below. This is intended to help you find the drawing relevant to you more quickly. Please take care to ensure that you use the relevant drawings for every network listed below as we may have multiple networks and multiple utilities in this area.

#### **N0003185-1**

##### **Gas**

- [N0003185-1.png](#)

This information is for guidance only and the precise position of the plant must be established, prior to your works, using hand-digging methods only. The contractor will be held responsible for any damage caused to our asset. Please note our assets now include those owned and operated by:

- GTC Pipelines Limited
- Independent Pipelines Limited
- Quadrant Pipelines Limited
- Electricity Network Company Limited
- Independent Power Networks Limited
- Independent Water Networks Limited
- Independent Fibre Networks Limited
- Independent Community Heating Limited

If you have any queries or require any further information please do not hesitate to contact us.

All works in the vicinity of our networks should be undertaken in accordance with the attached document "GU-DPR-IG-0022: Safe working in the vicinity of utility networks". Reference should also be made to HSG47 Avoiding Danger from Underground Services.

**Important: The area of your proposed works may contain gas mains operating at Medium and Intermediate Pressure tiers or electric cables operating at High Voltage – please refer to the network drawings included with this email. If your proposed works are likely to involve excavation within 10 metres of any of these assets, including but not limited to gas governors and electric substations you MUST inform GTC Plant Enquiries by calling 01359 240363 and quoting your Plant Enquiries Service Reference number.**

**Important: Drawings provided by this service may include utility assets not owned or managed by GTC. Conversely our drawings will NOT display assets from all third parties. It is your responsibility to ensure you have requested information from all utility asset owners.**

**Gas Escape or Damage MUST be reported on 0800 111 999. National Grid / DNGT will attend to make safe and repair.**

**Electricity Network Damage MUST be reported to ENC on 0800 032 6990.**

**Water Network Damage MUST be reported to IWNL on 02920 028 711**

**Fibre Network Damage MUST be reported to IFNL on 0845 051 1669**

**Thank you for using the GTC Plant Enquiries Service.**

Your sincerely,

GTC Plant Enquiry Service





## GU-DPR-IG-0022

### SAFE WORKING IN THE VICINITY OF UTILITY NETWORKS

(Refer to the HSE Guidance Document HSG47)

#### General

1. It is imperative that all works are carried out in accordance with the guidance provided by the HSE in their document HSG47 "Avoiding Danger from Underground Services", ISBN 0-7176-1744-0. No party should carry out any excavation works or other intrusive works such as piling, blasting or demolition without following the guidance in HSG47.
2. We own gas, electricity, water and fibre apparatus located in the highway, private property and through the countryside. Some plant may be located in land for which a wayleave or easement has been granted & there may be no surface evidence of the presence of apparatus.
3. Ensure that you have obtained detailed plans of existing and proposed gas, electricity water and fibre networks.
4. The position of the networks should be pinpointed as accurately as possible by reference to the plans and by means of a locating device, which has been tested and calibrated within the last twelve months.

Excavation work should be carried out where applicable, and carefully follow recognised safe digging practices. Once a locating device has been used to determine position and route, excavation may proceed; trial holes should be dug using suitable hand tools to confirm the position of buried networks. During excavation the locating device should be reused to check position and route of buried apparatus.

5. Hand-held power tools can damage buried apparatus and should be used with care until the exact position has been determined. They may only be used to break a paved or concrete surface above the network, unless there are any indications that the network is particularly shallow, in such circumstances, accuracy of plant location is determined and excavation initiated adjacent to the apparatus.
6. No manhole, chamber or other structure should be built over, around or under the network. Such structures, other pipes, ducts and cables should be laid to provide a minimum clearance from the network of 300mm or 1.5 times the diameter of the network, whichever is the greater. No work should be carried out if this minimum clearance cannot be met or which results in a reduction of cover or protection over the network, without first consulting GTC.
7. Where an excavation uncovers a network apparatus the backfill should be adequately compacted, particularly beneath the network, to prevent any settlement, which would subsequently damage the network. Backfill material adjacent to the network should be selected fine material or sand, containing no stones, bricks or lumps of concrete etc. and should be suitably compacted to give comparable support and protection to that provided before excavation. No power compaction should take place until 200mm cover of selected fine fill has been suitably compacted by hand tools.

8. If the road construction is close to the top of the network, GTC should be asked about necessary precautions. The road construction depth should not be reduced without permission from the local Highway Authority.
9. Costs incurred by GTC through direct or consequential damage will be recharged.

### **Precautions for Gas Networks**

10. Plans do not always show the presence of gas pipes cables (from the gas main to premises) but their existence should be assumed.
11. The depth of cover for gas mains is normally 750mm in carriageways and grass verges and 600mm in footways. The depth of cover for gas services is normally 450mm. Remember these covers are to finished level, you may be working in an area, which will be made up or lowered at a later date.
12. Plastic gas pipes should be located by hand digging before mechanical excavation begins. When the positions and depth of the pipes have been determined, work can proceed.
13. The danger created by damaging a gas pipe with an excavator is much greater than if the damage is done with a hand-held power tool (the opposite is true for work near electricity cables and this is reflected in the different safe digging practices). Gas pipes may have projections such as valve housings, which are not shown on the plans and to allow for this mechanical excavators should not be used within 500mm of a gas pipe.
14. If a gas leak is suspected, the following action should be taken immediately:
  - Remove all people from the immediate vicinity of the escape. If the service connection to a building or the adjacent main has been damaged, warn the occupants to leave the building, and any adjoining building, until it is safe for them to return. It is important to note that a mechanical excavator may not only cause damage/leakage at the point of impact. For example, damage to a service connection outside the building may result in further, unseen damage to the connection inside the building. Gas leaking from the damage inside or gas travelling along the line of the service connection pipe from outside the building may cause a build-up of gas within the building.
  - Prohibit smoking, and extinguish all naked flames and other sources of ignition i.e. stop excavator and compressor engines within at least 5.0m of the leak.
  - Inform National Grid by dialling **0800 111 999**
  - Remain on site.
  - Assist National Grid staff, Police or Fire Services as requested.
15. Where gas pipes cross or are parallel and close to excavations, changes in backfill etc. may cause differential ground settlement and increased stress in the pipe. For pipes parallel and close to excavations, the degree of risk depends upon the depth of the excavation, the distance of the pipe from the excavation, the type of soil and any excessive loading from heavy construction plant and materials. Wherever excavation works may affect the support of the gas pipe or cause excessive loading over the gas pipe then GTC must be consulted.

16. No concrete or other hard material should be placed or left under or adjacent to any gas pipe as this can cause pipe fracture at a later date. Concrete backfill should not be used within 300mm of a gas pipe.
17. Where an excavation uncovers a gas pipe with a damaged wrapping, GTC should be told, so that repairs can be made to prevent future corrosions and leakage.
18. Pipe restraints or thrust blocks close to gas mains should never be removed.
19. Anyone who carries out work near underground gas plant should observe any specific requirements made by the site manager, and ensure that access to the plant by National Grid Gas and GTC staff is available at all times. No unauthorised repairs to gas pipes should be made.
20. Where excavation is within 5 metres proximity to above or below ground pressure control equipment, ground workers must be aware of the possibility of encountering small impulse pipe work that is more susceptible to damage.
21. Where PE pipes and cables have been exposed and it is intended hot work (e.g. welding, grinding, etc) be carried out, contact must be made with GTC to confirm additional precautions and actions that may require to be undertaken.
22. GTC should be consulted if it is intended to carry out any of the following activities:
  - using explosives within 30m of gas pipes or 400m of gas pressure reduction equipment
  - piling or boring within 15m of gas plant
  - excavating within 10m of pressure reduction equipment
  - reducing the cover or protection of a gas pipe
  - carrying out nearby deep excavations
  - working near our intermediate pressure (IP) mains.

### **Precautions for Electricity Networks**

23. Plans do not always show the presence of electric service cables (from the electricity main to premises) but their existence should be assumed.
24. In most cases there will be no permanent surface marker posts or other visible indication of the presence of a buried cable. Even if no cables are shown on plans or detected by a locator, there may still be cables present, which could be live and a close watch should be kept for any signs which could indicate their presence such as marker tape, tape tile, concrete tiles and wooden battens. Any marker which is disturbed by our excavations must be replaced once work is completed.
25. Typically underground cables are laid in trenches between 450mm and 1.0m deep, although some high voltage cables will be deeper, however, depths should never be assumed.
26. A cable is positively located only when it has been safely exposed. Even then, digging should still proceed with care as there may be other cables adjacent or lower down.

27. Occasionally, cables are terminated in the ground by means of a seal, sometimes with external mechanical protection. These “pot ended” or “bottle ended” cables should be treated as live and should not be assumed to be abandoned or disused. They can be difficult to detect with locators even when “live”.
28. Using hand held power tools to break up hard surfaces often leads to accidents. Where practicable, such power tools should only be used 500mm or more away from the indicated line of a cable buried in or below a hard surface. Having done so, the cable should then be positively located by careful hand digging under the hard surface. The hard surface should be gradually removed until the cable is exposed. If the cable is not exposed then it must be assumed to be embedded within the surface. Where possible a cable locator should be used as a depth guide down the side of the excavation.
29. Because of the difficulty in confirming depth, hand held power tools should never be used over the cable unless either:
  - the cable has already been exposed by digging under the surface to be broken out and it is at a safe depth (at least 300mm) below the bottom of the hard surface material; or
  - physical precautions have been taken to prevent the tool striking the cable.
30. Excavating close to electricity cables buried in concrete is dangerous and should not be undertaken unless the cable(s) have been isolated. For this reason alone electricity cables should not be buried in concrete.
31. Using mechanical means to break up concrete can cause damage to cables and if the cable is live, anyone present is likely to be injured.
32. Where mechanical excavators are used in the possible vicinity of underground cables, the work should be arranged so that damage to cables is avoided so far as is reasonably practicable and so that everyone is kept well clear of the excavator bucket while it is digging. Drivers should have been instructed to stay in the cab if a cable is struck. If they have to leave the cab, they should jump clear. If drivers climb down, they may be electrocuted. When a cable is struck, a watch should be kept on the machine and no one should go down into the excavation or approach the mechanical excavator or the cable until GTC are contacted and arranged for the damaged cable to be made safe.
33. Where cables have been exposed:
  - any damage should be reported to GTC immediately on **0800 032 6990** and work should not be undertaken in the vicinity of a damaged cable until GTC has investigated its condition;
  - for more than 1.0m and they cross a trench, support should be provided. If the exposed cable length is shorter than 1.0m support should still be considered if joints have been exposed or the cable appears otherwise vulnerable to damage. Where advice and help is needed contact GTC;

- Suitable precautions should be taken to prevent damage from on-going work in the excavation. This may involve for example the use of physical means (e.g. timber boards, sandbags etc) to prevent mechanical damage. Materials or equipment which could damage or penetrate the outer sheath of the cable should not be used. Cables lying in the bottom of an excavation are particularly vulnerable and should be protected by nail free wooden planks, troughing or other suitable means;
  - cables should not be moved aside unless the operation is supervised by GTC;
  - Precautions should be taken to prevent access by members of the public.
34. GTC should be consulted if it is intended to carry out any of the following activities:
- using explosives within 30m of plant or substations piling or boring within 15m of electric plant
  - excavating within 10m of a substation
  - carrying out nearby deep excavations
  - working near our HV plant.

### **Precautions for Water Networks**

35. Plans do not always show the presence of water service cables (from the water main to premises) but their existence should be assumed.
36. The depth of cover for water mains is normally 750mm in carriageways and grass verges and 750mm footways. The depth of cover for water services is normally 450mm. Remember these covers are to finished level, you may be working in an area, which will be made up or lowered at a later date.
37. Water mains should be located by hand digging before mechanical excavation begins. When the positions and depth of the pipes have been determined, work can proceed.
38. The danger created by damaging a water pipe with an excavator is much greater than if the damage is done with a hand-held power tool (the opposite is true for work near electricity cables and this is reflected in the different safe digging practices). Water pipes may have projections such as valve housings, which are not shown on the plans and to allow for this mechanical excavators should not be used within 500mm of a water pipe.
39. If a water leak is suspected, the following action should be taken immediately:
- Remove all people from the immediate vicinity of the damage. It is important to note that a mechanical excavator may not only cause damage/leakage at the point of impact. For example, damage to a service connection outside the building may result in further, unseen damage to the connection inside the building.
  - Shut down all working plant and machinery in the vicinity of the damage
  - Inform IWNL by dialling **02920 028 711**.
  - Remain on site.

- Do not attempt to make a repair.
  - Assist GTC, approved contractors and Police or Fire Services as requested.
40. Where water pipes cross or are parallel and close to excavations, changes in backfill etc. may cause differential ground settlement and increased stress in the pipe. For pipes parallel and close to excavations, the degree of risk depends upon the depth of the excavation, the distance of the pipe from the excavation, the type of soil and any excessive loading from heavy construction plant and materials. Wherever excavation works may affect the support of the water pipe or cause excessive loading over the water pipe then GTC must be consulted.
  41. No concrete or other hard material should be placed or left under or adjacent to any water pipe as this can cause pipe fracture at a later date. Concrete backfill should not be used within 300mm of a water pipe.
  42. Where an excavation uncovers a water pipe with a damaged wrapping, GTC should be told, so that repairs can be made to prevent future corrosions and leakage.
  43. Pipe restraints or thrust blocks close to water mains should never be removed.
  44. Anyone who carries out work near underground water plant should observe any specific requirements made by the site manager, and ensure that access to the plant by GTC staff is available at all times. No unauthorised repairs to water pipes should be made.
  45. Where PE pipes and cables have been exposed and it is intended hot work (e.g. welding, grinding, etc) be carried out, contact must be made with GTC to confirm additional precautions and actions that may require to be undertaken.
  46. GTC should be consulted if it is intended to carry out any of the following activities:
    - using explosives within 30m of plant
    - piling or boring within 15m of water plant
    - excavating within 10m of water asset structures
    - reducing the cover or protection of a water main or service
    - carrying out nearby deep excavations

### **Precautions for Fibre Networks**

47. Plans may not always show the presence of fibre ducts but their existence should be assumed if GTC advise they have fibre services deployed in the given area. Any planned excavation work should only proceed with due care and attention.
48. Chambers with IFNL marked lids can be used as an onsite indicator that GTC have fibre plant deployed in a given area however an exclusion of their presence does not necessarily mean there is no plant present.
49. In most cases there will be no permanent surface marker posts or other visible indication of the presence of a buried fibre duct. Even if no ducts are shown on plans there may still be ducts present which could have live fibre service installed. A close watch should be kept for any signs which could indicate duct presence such as marker tape. Any marker which is disturbed by our excavations must be replaced once work is completed.

50. The depth of cover for fibre duct is normally 350mm in footways and grass verges, 600mm in carriageways and 1000mm in agricultural deployments. Remember these covers are to finished level, you may be working in an area, which will be made up or lowered at a later date.
51. Fibre ducts should be located by hand digging before mechanical excavation begins. When the positions and depth of the ducts have been determined, work can proceed. Even then, digging should still proceed with care as there may be other ducts adjacent or lower down.
52. If fibre duct damage is suspected, the following action should be taken immediately:
  - Remove all people from the immediate vicinity of the damage. It is important to note that a mechanical excavator may not only cause damage at the point of impact. For example, damage to a fibre connection outside the building may result in further, unseen damage to the connection inside the building.
  - Shut down all working plant and machinery in the vicinity of the damage
  - Inform IFNL NOC immediately on **0845 051 1669**.
  - Remain on site.
  - Do not attempt to make a repair.
53. Where fibre ducts cross or are parallel and close to excavations, changes in backfill etc. may cause differential ground settlement and increased stress on the duct. For ducts parallel and close to excavations, the degree of risk depends upon the depth of the excavation, the distance of the duct from the excavation, the type of soil and any excessive loading from heavy construction plant and materials. Wherever excavation works may affect the support of the fibre duct or cause excessive loading over the fibre duct then GTC must be consulted.
54. No concrete or other hard material should be placed or left under or adjacent to any fibre duct as this can cause damage to the duct at a later date. Any backfill should comply with the requirements of NRSWA. Concrete backfill should not be used within 300mm of a fibre duct.
55. Anyone who carries out work near underground fibre plant should observe any specific requirements made by the site manager, and ensure that access to the plant by GTC staff is available at all times. No unauthorised repairs to fibre ducts should be made.
56. Where fibre ducts have been exposed and it is intended hot work (e.g. welding, grinding, etc) be carried out, contact must be made with GTC to confirm additional precautions and actions that may require to be undertaken.
57. GTC should be consulted if it is intended to carry out any of the following activities:
  - using explosives within 30m of plant or fibre asset structures
  - piling or boring within 15m of fibre plant
  - excavating within 10m of fibre asset structures (including the OSCP)
  - reducing the cover or protection of a fibre duct
  - carrying out nearby deep excavations



Gas



Stephen Sawyer  
Technics Group  
Technics House  
Guildford  
Guildford  
Surrey  
GU4 7WA

**Date:** 20/03/2015

**Our Ref:** NL\_TE\_Z5\_3SWX\_140163

**Your Ref:** GRS00347

**RE: Proposed Works, Growing Concerns Garden Centre, 2 Wick Lane, Tower Hamlets, Greater London, E3 2NA**

Thank you for your enquiry which was received on 20/03/2015.  
Please note this response and any attached map(s) are valid for 28 days.

An assessment has been carried out with respect to National Grid Electricity Transmission plc's and National Grid Gas plc's apparatus. Please note it does not cover the items listed in the section "Your Responsibilities and Obligations", including gas service pipes and related apparatus.

**As your works are at a "proposed" stage, any maps and guidance provided are for information purposes only. This is not approval to commence work. You must submit a "Scheduled Works" enquiry at the earliest opportunity and failure to do this may lead to disruption to your plans and works. National Grid will endeavour to provide an initial assessment within 14 days of receipt of a Scheduled Works enquiry and dependent on the outcome of this, further consultation may be required.**

**In any event, for safety and legal reasons, works must not be carried out until a Scheduled Works enquiry has been completed and final response received.**

## Your Responsibilities and Obligations

The "Assessment" Section below outlines the detailed requirements that must be followed when planning or undertaking your scheduled activities at this location.

It is your responsibility to ensure that the information you have submitted is accurate and that all relevant documents including links are provided to all persons (either direct labour or contractors) working for you near National Grid's apparatus, e.g. as contained within the Construction (Design and Management) Regulations.

This assessment solely relates to National Grid Electricity Transmission plc (NGET) and National Grid Gas plc (NGG) apparatus. This assessment does **NOT** include:

- National Grid's legal interest (easements or wayleaves) in the land which restricts activity in proximity to National Grid's assets in private land. You must obtain details of any such restrictions from the landowner in the first instance and if in doubt contact National Grid.
- Gas service pipes and related apparatus
- Recently installed apparatus
- Apparatus owned by other organisations, e.g. other gas distribution operators, local electricity companies, other utilities, etc.

This communication does not constitute any formal agreement or consent for any proposed development work; either generally or with regard to National Grid's easements or wayleaves nor any planning or building regulations applications.

NGG and NGET or their agents, servants or contractors do not accept any liability for any losses arising under or in connection with this information. This limit on liability applies to all and any claims in contract, tort (including negligence), misrepresentation (excluding fraudulent misrepresentation), breach of statutory duty or otherwise. This limit on liability does not exclude or restrict liability where prohibited by the law nor does it supersede the express terms of any related agreements.

# ASSESSMENT

## Affected Apparatus

The National Grid apparatus that has been identified as being in the vicinity of your proposed works is:

- Low or Medium pressure (below 2 bar) gas pipes and associated equipment. (As a result it is highly likely that there are gas services and associated apparatus in the vicinity)
- Electricity Transmission underground cables and associated equipment

## Requirements

**BEFORE carrying out any work you must:**

- **Refer to the attached cable profile drawings (if any) which provide details about the location of National Grid's high voltage underground cables.**
- Carefully read these requirements including the attached guidance documents and maps showing the location of National Grid apparatus.
- Contact the landowner and ensure any proposed works in private land do not infringe National Grid's legal rights (i.e. easements or wayleaves). If the works are in the road or footpath the relevant local authority should be contacted.
- Ensure that all persons, including direct labour and contractors, working for you on or near National Grid's apparatus follow the requirements of the HSE Guidance Notes HSG47 - 'Avoiding Danger from Underground Services' and GS6 – 'Avoidance of danger from overhead electric power lines'. This guidance can be downloaded free of charge at <http://www.hse.gov.uk>
- In line with the above guidance, verify and establish the actual position of mains, pipes, cables, services and other apparatus on site before any activities are undertaken.

# GUIDANCE

## **Electricity Underground Cables Guidance:**

<http://www.nationalgrid.com/NR/rdonlyres/1174F509-0F16-4B68-8CF6-63FE27919E0A/51895/ElectricityUndergroundCableguidance.pdf>

## **Excavating Safely - Avoiding injury when working near gas pipes:**

[http://www.nationalgrid.com/NR/rdonlyres/2D2EEA97-B213-459C-9A26-18361C6E0B0D/25249/Digsafe\\_leaflet3e2finalamends061207.pdf](http://www.nationalgrid.com/NR/rdonlyres/2D2EEA97-B213-459C-9A26-18361C6E0B0D/25249/Digsafe_leaflet3e2finalamends061207.pdf)

## **Standard Guidance**

### **Essential Guidance document:**

<http://www.nationalgrid.com/NR/rdonlyres/6D6525F9-59EB-4825-BA89-DBD7E68882C7/51319/EssentialGuidance.pdf>

### **General Guidance document:**

<http://www2.nationalgrid.com/WorkArea/DownloadAsset.aspx?id=35103>

### **Excavating Safely in the vicinity of gas pipes guidance (Credit card):**

<http://www.nationalgrid.com/NR/rdonlyres/A3D37677-6641-476C-9DDA-E89949052829/44257/ExcavatingSafelyCreditCard.pdf>

### **Excavating Safely in the vicinity of electricity cables guidance (Credit card):**

<http://www.nationalgrid.com/NR/rdonlyres/35DDEC6D-D754-4BA5-AF3C-D607D05A25C2/44858/ExcavatingSafelyCreditCardelectricitycables.pdf>



ID: NL\_TE\_Z5\_3SWX\_140163  
 USER: utilityreports  
 DATE: 20/03/2015  
 DATA DATE: 19/03/2015  
 REF: GRS00347  
 MAP REF: TQ3684  
 CENTRE: 536838, 184052

View extent: 1445m, 785m

LP MAINS	
MP MAINS	
IP MAINS	
LHP MAINS	
NHP MAINS	

0m 100m  
 Approximate scale 1:5000  
 on A4 Colour Landscape

**Map not to be used for construction**



This plan shows those pipes owned by National Grid Gas plc in its role as a Licensed Gas Transporter (GT). Gas pipes owned by other GTs, or otherwise privately owned, may be present in this area. Information with regard to such pipes should be obtained from the relevant owners. The information shown on this plan is given without warranty, the accuracy thereof cannot be guaranteed. Service pipes, valves, syphons, stub connections, etc., are not shown but their presence should be anticipated. No liability of any kind whatsoever is accepted by National Grid Gas plc or their agents, servants or contractors for any error or omission. Safe digging practices, in accordance with HS(G)47, must be used to verify and establish the actual position of mains, pipes, services and other apparatus on site before any mechanical plant is used. It is your responsibility to ensure that this information is provided to all persons (either direct labour or contractors) working for you on or near gas apparatus. The information included on this plan should not be referred to beyond a period of 28 days from the date of issue.

Map 1 of 2 (GAS)  
 MAPS Plot Server Version 1.8.0  
  
 Requested by: Technics Group  
 This plan is reproduced from or based on the OS map by National Grid Gas plc, with the sanction of the controller of HM Stationery Office. Crown Copyright Reserved. Ordnance Survey Licence number 100024886

Valve	Depth of Cover	Syphon	Diameter Change	Material Change
-------	----------------	--------	-----------------	-----------------



ID: NL\_TE\_Z5\_3SWX\_140163  
 USER: utilityreports  
 DATE: 20/03/2015  
 DATA DATE: 04/07/2014  
 REF: GRS00347  
 MAP REF: TQ3684  
 CENTRE: 536838, 184052

View extent: 2890m, 1570m  
 Underground cables   
 Overhead lines   
 0m  200m  
 Approximate scale 1:10000  
 on A4 Colour Landscape

**Map not to be used for construction**

This plan shows those cables owned by National Grid Electricity Transmission plc in its role as a Licensed Electricity Transporter (ET). Electricity cables owned by other ETs, or otherwise privately owned, may be present in this area. Information with regard to such cables should be obtained from the relevant owners. The information shown on this plan is given without warranty, the accuracy thereof cannot be guaranteed. Ancillary equipment such as cooling systems and communication cables are not shown but their presence should be anticipated. No liability of any kind whatsoever is accepted by National Grid Electricity Transmission plc or their agents, servants or contractors for any error or omission. Safe digging practices, in accordance with HS(G)47, must be used to verify and establish the actual position of cables and other apparatus on site before any mechanical plant is used. It is your responsibility to ensure that this information is provided to all persons (either direct labour or contractors) working for you on or near electricity apparatus. The information included on this plan should not be referred to beyond a period of 28 days from the date of issue.

Map 2 of 2 (ELECTRIC)  
 MAPS Plot Server Version 1.8.0  
  
 Requested by: Technics Group  
 This plan is reproduced from or based on the OS map by National Grid Electricity Transmission plc, with the sanction of the controller of HM Stationery Office. Crown Copyright Reserved. Ordnance Survey Licence number 100024241

# ENQUIRY SUMMARY

## Received Date

20/03/2015

## Your Reference

GRS00347

## Location

Centre Point: 536838, 184052

X Extent: 303

Y Extent: 276

Postcode: E3 2NA

Location Description: Growing Concerns Garden Centre, 2 Wick Lane, Tower Hamlets, Greater London, E3 2NA

## Map Options

Paper Size: A4

Orientation: LANDSCAPE

Requested Scale: 2500

Actual Scale: 1:5000 (GAS), 1:10000 (ELECTRIC)

Real World Extents: 1445m x 785m (GAS), 2890m x 1570m (ELECTRIC)

## Recipients

utility.reports@technicsgroup.com

## Enquirer Details

Organisation Name: Technics Group

Contact Name: Stephen Sawyer

Email Address: utility.reports@technicsgroup.com

Telephone: 01483 230080

Address: Technics House, Guildford, Guildford, Surrey, GU4 7WA

## Description of Works

Growing Concerns Garden Centre, 2 Wick Lane, Tower Hamlets, Greater London, E3 2NA

## Enquiry Type

Proposed Works

## Activity Type

Utility Works

## Work Types

Work Type: Plans Only



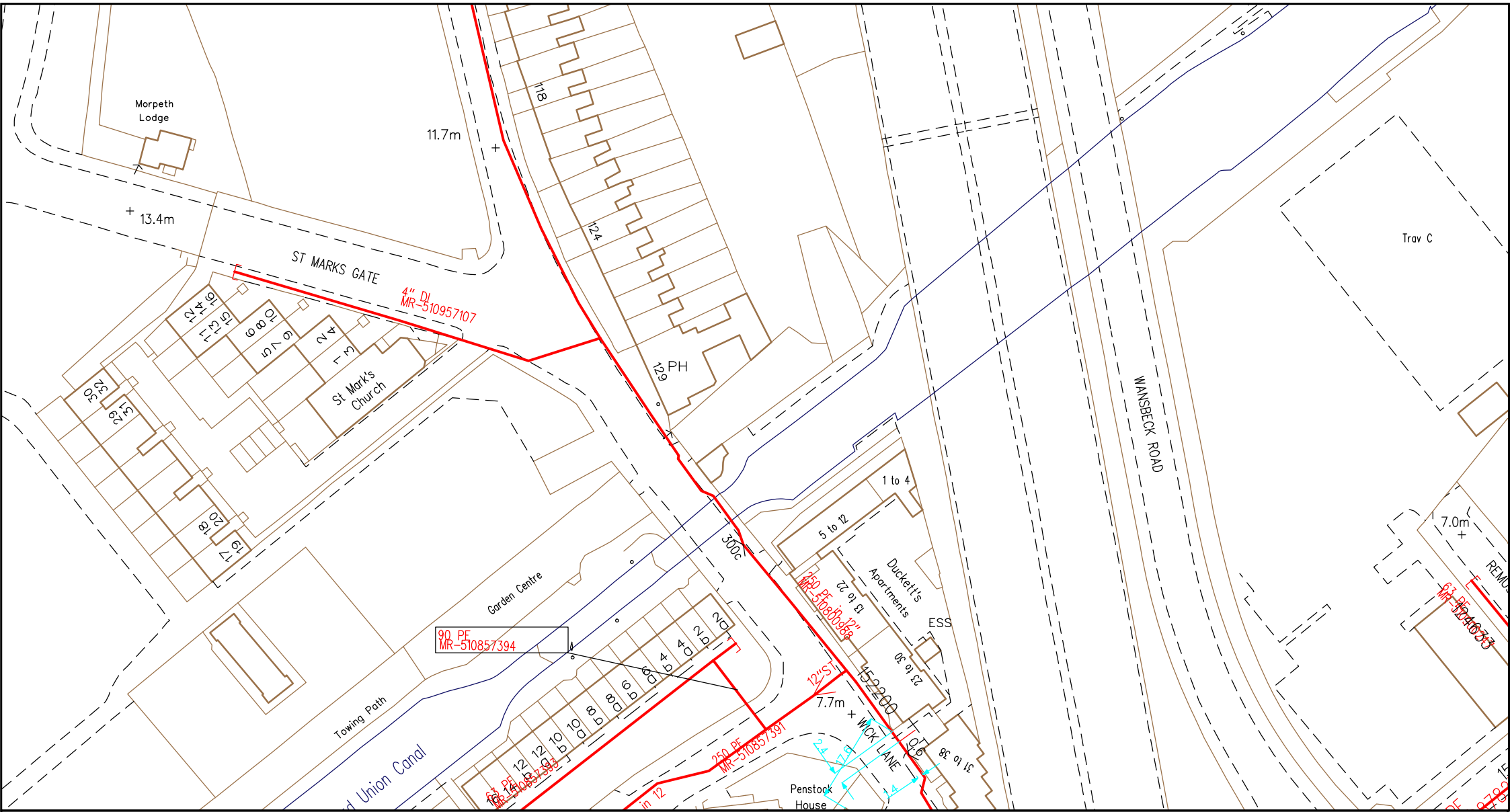

SCALE: Not to scale
USER ID: stephen
DATE: 24/03/2015
EXTRACT DATE: 12/12/2014
MAP REF: TQ3684
CENTRE: 536929, 184135

LP MAINS	
MP MAINS	
IP MAINS	
LHP MAINS	
NHP MAINS	

This plan shows those pipes owned by National Grid Gas plc in their role as a Licensed Gas Transporter (GT). Gas pipes owned by other GTs, or otherwise privately owned, may be present in this area. Information with regard to such pipes should be obtained from the relevant owners. The information shown on this plan is given without warranty, the accuracy thereof cannot be guaranteed. Service pipes, valves, syphons, stub connections, etc. are not shown but their presence should be anticipated. No liability of any kind whatsoever is accepted by National Grid Gas plc or their agents, servants or contractors for any error or omission. Safe digging practices, in accordance with HS(G)47, must be used to verify and establish the actual position of mains, pipes, services and other apparatus on site before any mechanical plant is used. It is your responsibility to ensure that this information is provided to all persons (either direct labour or contractors) working for you on or near gas apparatus. The information included on this plan should not be referred to beyond a period of 28 days from the date of issue. Further information on all DR4s can be determined by calling the DR4 hotline on 01455 892426 (9am-5pm) A DR4 is where a potential error has been identified within the asset record and a process is currently underway to investigate and resolve the error as appropriate.

MAPS Viewer Version 5.6.7.0

Local Machine

This plan is reproduced from or based on the OS map by National Grid Gas plc, with the sanction of the controller of HM Stationery Office. Crown Copyright Reserved.



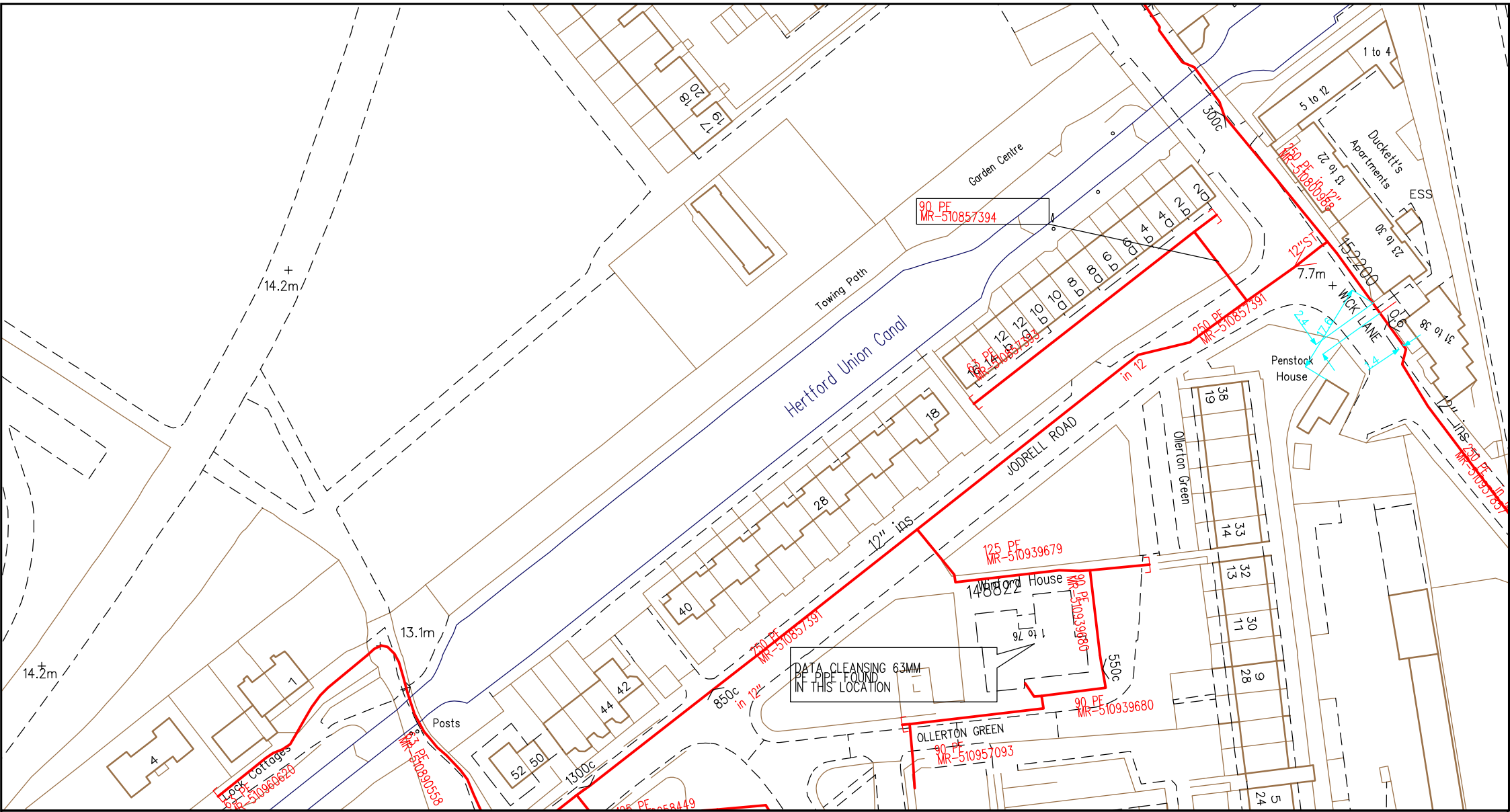

SCALE: Not to scale
USER ID: stephen
DATE: 24/03/2015
EXTRACT DATE: 12/12/2014
MAP REF: TQ3684
CENTRE: 536833, 184049

LP MAINS	
MP MAINS	
IP MAINS	
LHP MAINS	
NHP MAINS	

This plan shows those pipes owned by National Grid Gas plc in their role as a Licensed Gas Transporter (GT). Gas pipes owned by other GTs, or otherwise privately owned, may be present in this area. Information with regard to such pipes should be obtained from the relevant owners. The information shown on this plan is given without warranty, the accuracy thereof cannot be guaranteed. Service pipes, valves, syphons, stub connections, etc. are not shown but their presence should be anticipated. No liability of any kind whatsoever is accepted by National Grid Gas plc or their agents, servants or contractors for any error or omission. Safe digging practices, in accordance with HS(G)47, must be used to verify and establish the actual position of mains, pipes, services and other apparatus on site before any mechanical plant is used. It is your responsibility to ensure that this information is provided to all persons (either direct labour or contractors) working for you on or near gas apparatus. The information included on this plan should not be referred to beyond a period of 28 days from the date of issue. Further information on all DR4s can be determined by calling the DR4 hotline on 01455 892426 (9am-5pm) A DR4 is where a potential error has been identified within the asset record and a process is currently underway to investigate and resolve the error as appropriate.

MAPS Viewer Version 5.6.7.0

Local Machine

This plan is reproduced from or based on the OS map by National Grid Gas plc, with the sanction of the controller of HM Stationery Office. Crown Copyright Reserved.

Some examples of Plant Items:

Valve	Depth of Cover	Syphon	Diameter Change	Material Change
-------	----------------	--------	-----------------	-----------------

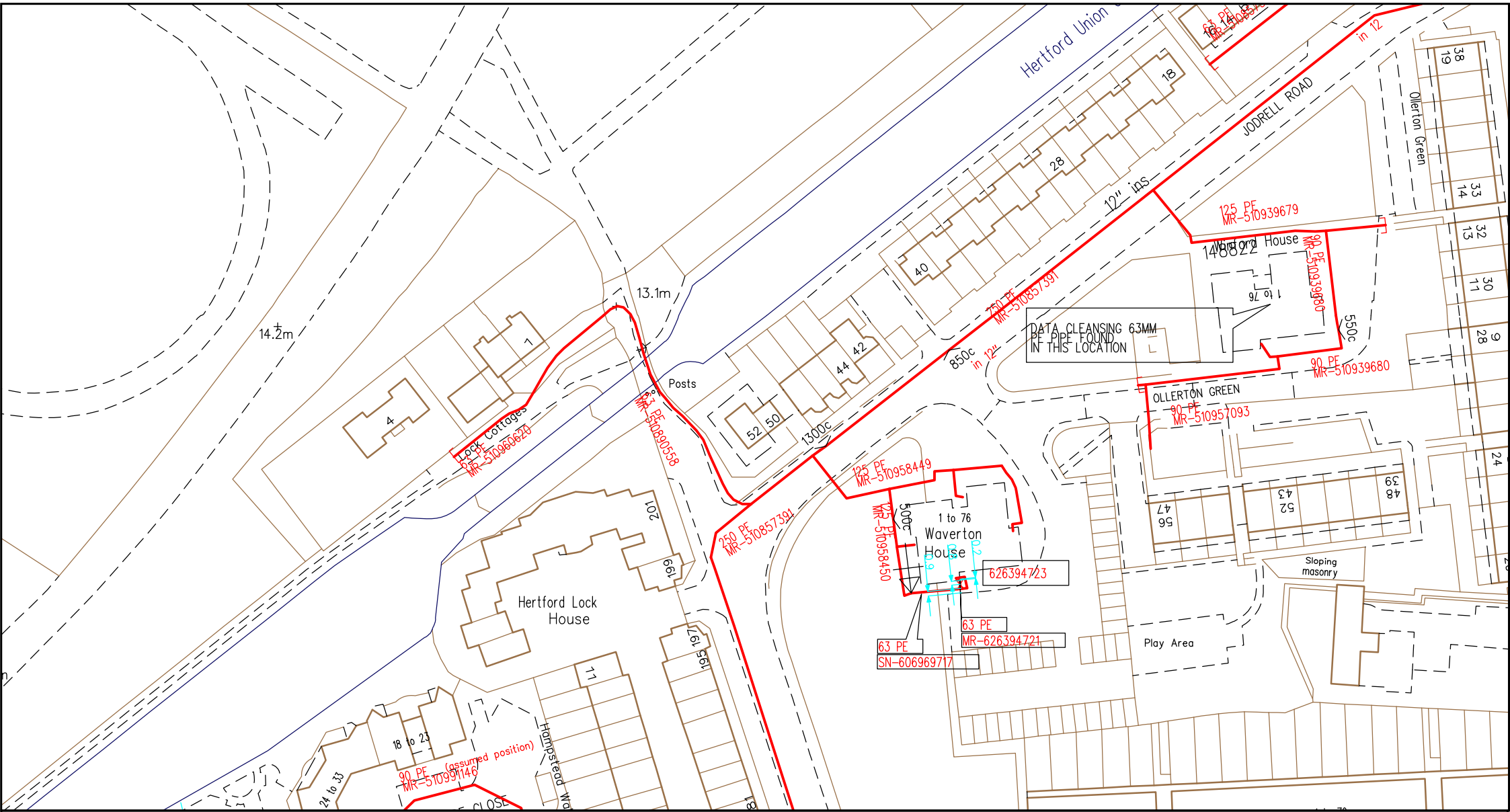

SCALE: Not to scale
USER ID: stephen
DATE: 24/03/2015
EXTRACT DATE: 12/12/2014
MAP REF: TQ3683
CENTRE: 536787, 183982

LP MAINS	
MP MAINS	
IP MAINS	
LHP MAINS	
NHP MAINS	

This plan shows those pipes owned by National Grid Gas plc in their role as a Licensed Gas Transporter (GT). Gas pipes owned by other GTs, or otherwise privately owned, may be present in this area. Information with regard to such pipes should be obtained from the relevant owners. The information shown on this plan is given without warranty, the accuracy thereof cannot be guaranteed. Service pipes, valves, syphons, stub connections, etc. are not shown but their presence should be anticipated. No liability of any kind whatsoever is accepted by National Grid Gas plc or their agents, servants or contractors for any error or omission. Safe digging practices, in accordance with HS(G)47, must be used to verify and establish the actual position of mains, pipes, services and other apparatus on site before any mechanical plant is used. It is your responsibility to ensure that this information is provided to all persons (either direct labour or contractors) working for you on or near gas apparatus. The information included on this plan should not be referred to beyond a period of 28 days from the date of issue. Further information on all DR4s can be determined by calling the DR4 hotline on 01455 892426 (9am-5pm) A DR4 is where a potential error has been identified within the asset record and a process is currently underway to investigate and resolve the error as appropriate.

MAPS Viewer Version 5.6.7.0

Local Machine

This plan is reproduced from or based on the OS map by National Grid Gas plc, with the sanction of the controller of HM Stationery Office. Crown Copyright Reserved.

Some examples of Plant Items:

Valve	Depth of Cover	Syphon	Diameter Change	Material Change
-------	----------------	--------	-----------------	-----------------

THIS DOCUMENT IS FOR VIEWING PURPOSES ONLY - NOT TO BE TREATED AS THE MASTER DRAWING

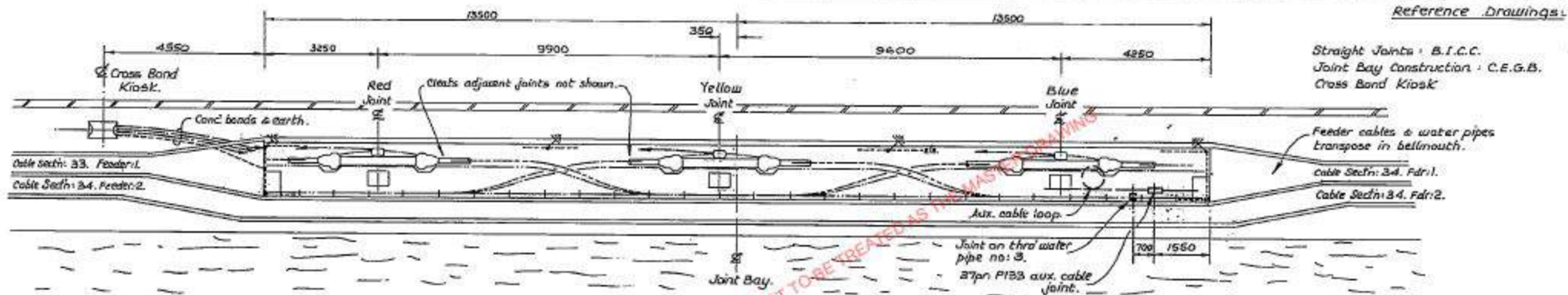

Reference Drawings:  
 Straight Joints: B.I.C.C. : E95480 - D1.  
 Joint Bay Construction: C.E.G.B. : 16/16308, rev.A  
 Cross Band Kiask : E90348 - D3.

Layout of Straight Joint Bay ~ 33/34. Scale - 1:100

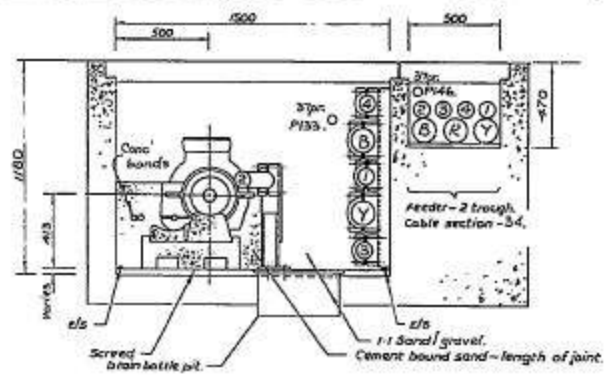

Section on Red Phase Joint.

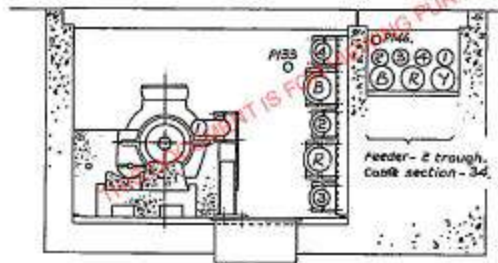

Section on Yellow Phase Joint.

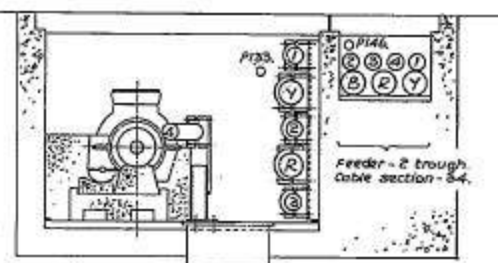

Section on Blue Phase Joint.

Cross Sections Facing West Nam. Scale: 1:25

Jointing Details ~ Feeder Cables.			
Phase	Type of Cable.	Jointer.	Date.
R	400 kv. S.C. 2000 <sup>mm</sup> all filled lead sheath.	D. Kerr.	10-7-80
Y	---	---	15-7-80
B	---	---	18-7-80

Jointing Details ~ Auxiliary Cables.			
	Type of Cable.	Jointer.	Date.
P153	37pin 1/0-5mm Pe. Pa. Awl. Pe. jelly filled.	B. Mansfield.	25-7-80

70/3620 SHT 108

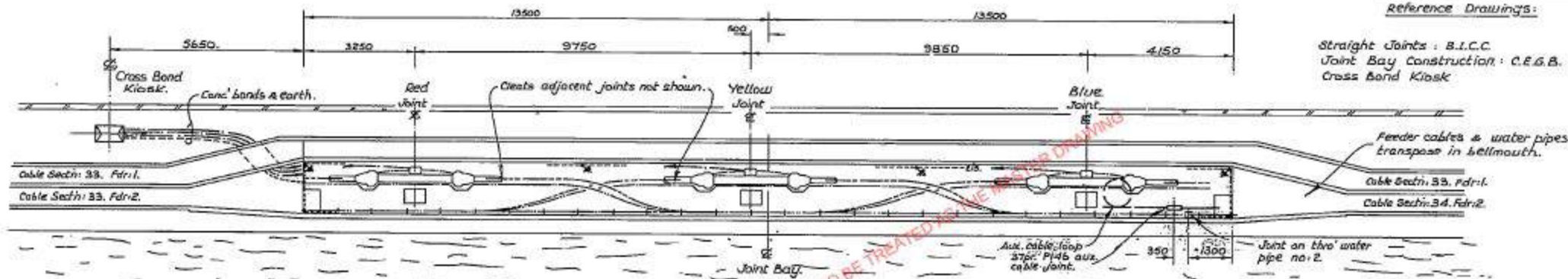

Reference Drawings:  
 Straight Joints: B.I.C.C. : E95480-D1.  
 Joint Bay Construction: C.E.G.B. : 16/16.307 rev. A.  
 Cross Bond Kiosk : E90348-D3.

Layout of Straight Joint Bay - 33/34. Scale - 1:100

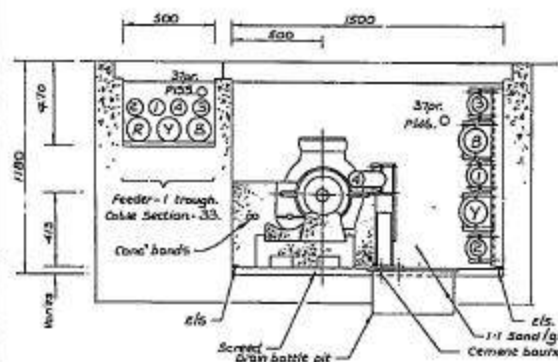

Section on Red Phase Joint.

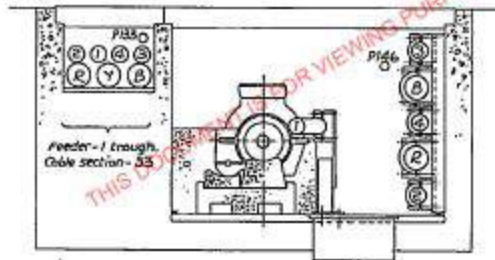

Section on Yellow Phase Joint.

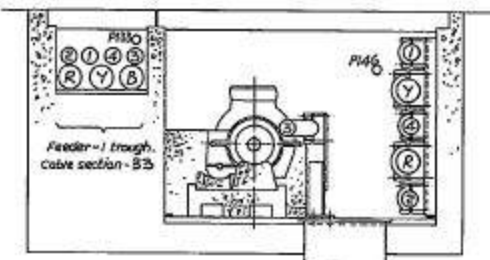

Section on Blue Phase Joint.

THIS DOCUMENT IS FOR VIEWING PURPOSES ONLY - NOT TO BE TREATED AS THE MASTER DRAWING

Jointing Details ~ Feeder Cables.

Phase	Type of Cable.	Jointer.	Date.
R	400 kv. S.C. 2000 <sup>2</sup> mm. oil filled, lead sheath.	D. Kerr.	14-2-80
Y	—	—	11-2-80
B	—	—	6-2-80

Jointing Details ~ Auxiliary Cables.

	Type of Cable.	Jointer	Date.
P146	37pc. 1/0.3mm. P.C. P.C. AWG. P.C. jelly filled.	J. Kerridge.	28-8-80

70/3620 SHT 109

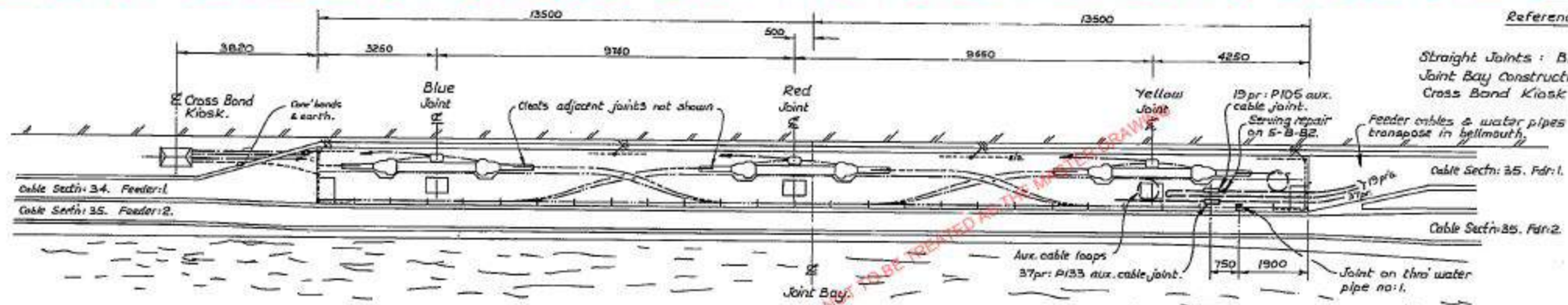

Layout of Straight Joint Bay ~ 34/35, Scale - 1:100

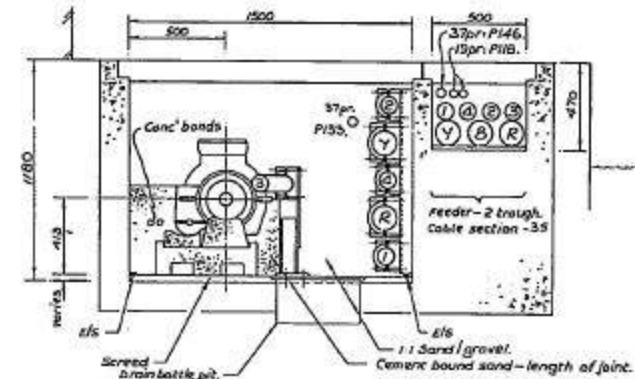

Section on Blue Phase Joint.

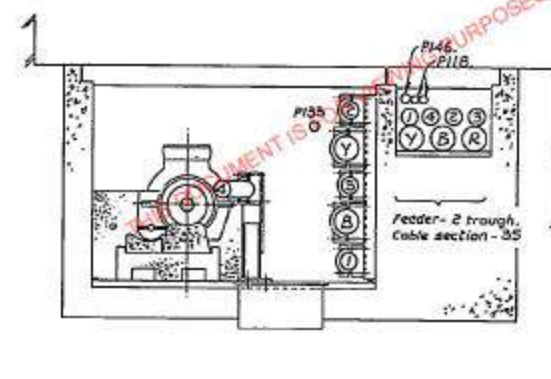

Section on Red Phase Joint.

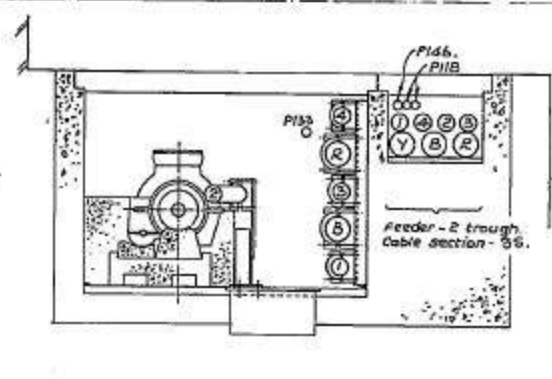

Section on Yellow Phase Joint.

Cross Sections Facing West Ham, Scale - 1:25

Jointing Details ~ Feeder Cables.			
Phase	Type of Cable.	Jointer	Date
R	400 kv. S.C. 2000 <sup>2</sup> mm. oil filled, lead sheath.	V. Stuchbury.	20-11-81.
Y	—	—	25-11-81.
B	—	—	17-11-81.

Jointing Details ~ Auxiliary Cables.			
	Type of Cable	Jointer	Date.
P133	37pr. 1/0.9mm. Pe. Pe. AWA. Pe. jelly filled.	B. Mansfield.	13-1-82.
P105	19pr. 1/0.9mm. Pe. Pe. AWA. Pe. jelly filled.	—	14-1-82.

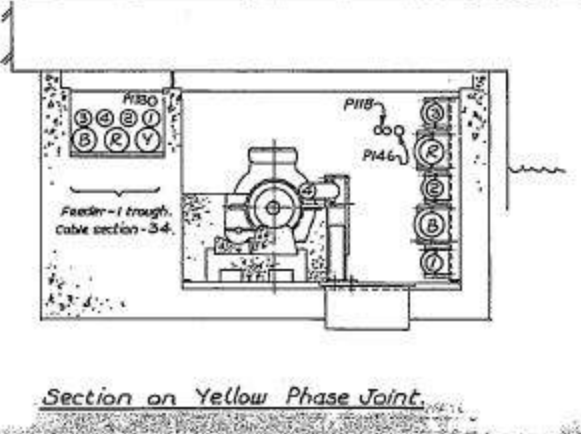
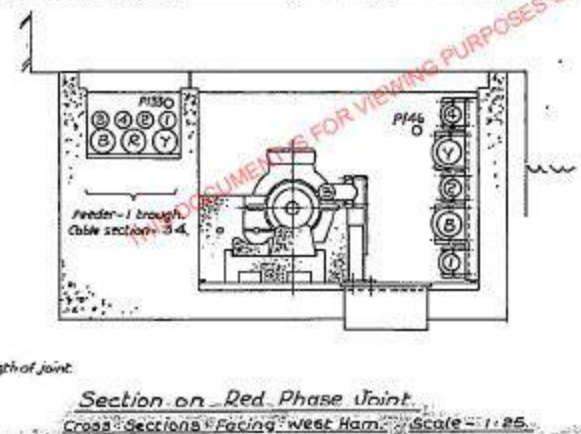
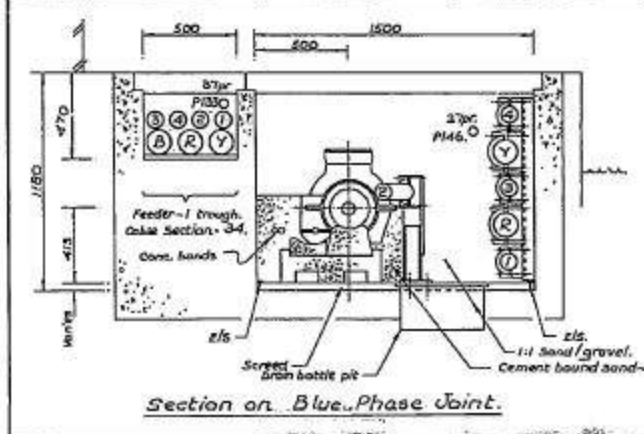
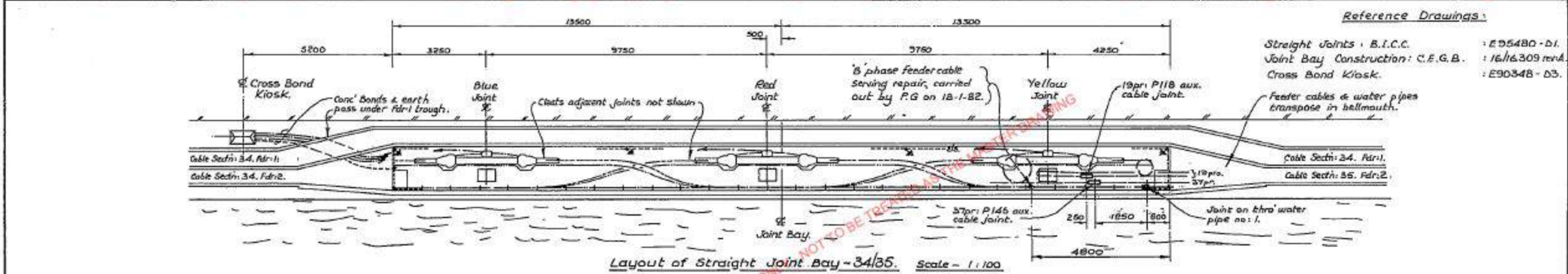

Phase	Type of Cable.	Jointer.	Date.
R	400 kv. S.C. 2000 mm. all filled. Lead sheath.	V. Stuchbury.	4-12-81.
Y	—	—	1-12-81.
B	—	—	9-12-81.

Type of Cable.	Jointer.	Date.
PI46. 57pr. 110.9mm. Pz. Pe. AWA. Pe. jelly filled.	B. Mansfield.	19-1-82.
PI18. 19pr. 110.9mm. Pz. Pe. AWA. Pe. jelly filled.	—	23-1-82.

70/3620 SHT-114

THIS DOCUMENT IS FOR VIEWING PURPOSES ONLY - NOT TO BE TREATED AS THE MASTER DRAWING

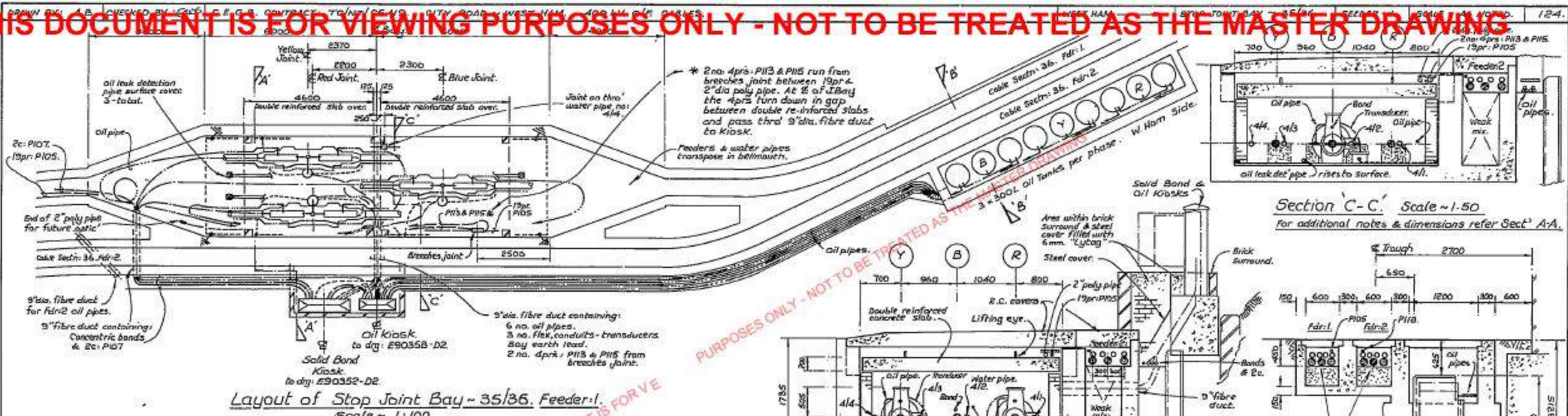

Layout of Stop Joint Bay ~ 35/36, Feeder 1.  
Scale ~ 1:100.

Symbols Key.	
-----	Feeder Cable.
-----	Water Pipe.
-----	Aux. cable.
-----	Earth.
-----	Oil Pipe.
-----	Transducer Lead.
-----	Conc. Bond.
-----	2" dia. poly pipe.

Joining Details				
Joint.	Phase	Type of Cable	Joiner.	Date.
Firelli General Stop Joints to PG. drg. no: 5610bl.	R.	400 kv S.C. 2000 <sup>9</sup> mm. Oil Filled, Lead Sheath.	E. Finch.	17-6-80
	Y.		E. Finch.	10-6-80
	B.		E. Finch.	3-6-80
19pr. aux.	P105	19pr. 1/4-2mm. Pp. Pp. Anod. Pp. Jetty Filled.	B. Mansfield	2-10-81

THIS DOCUMENT IS FOR VIEWING PURPOSES ONLY - NOT TO BE TREATED AS THE MASTER DRAWING

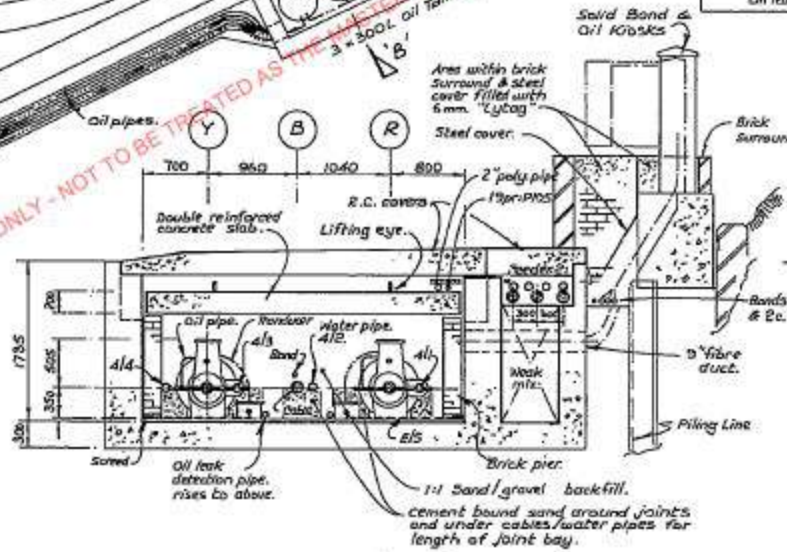
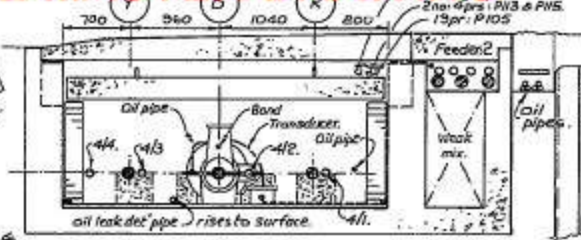

Section 'A-A' Scale ~ 1:50.

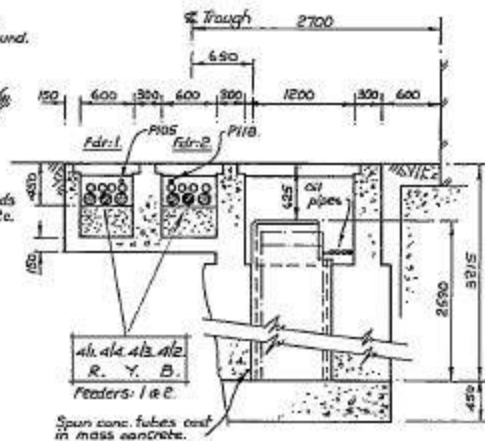



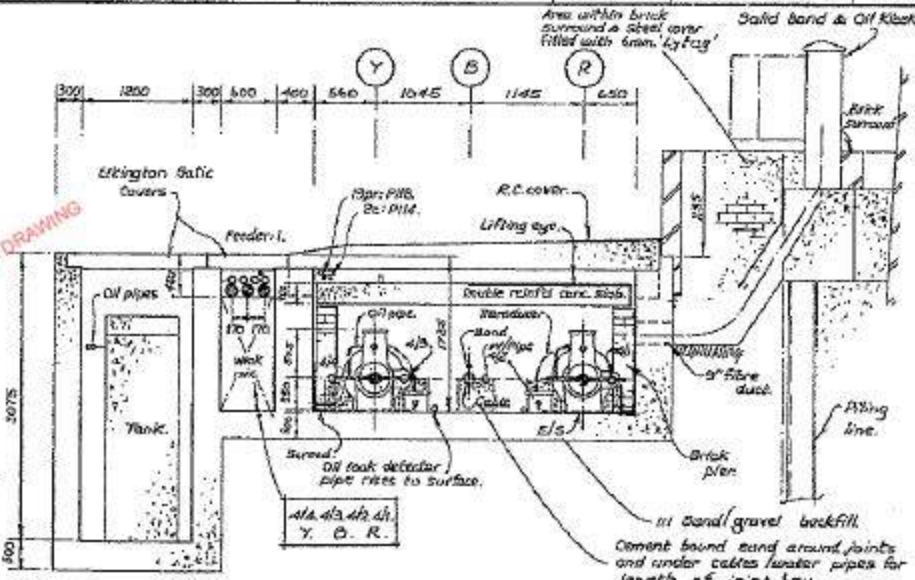
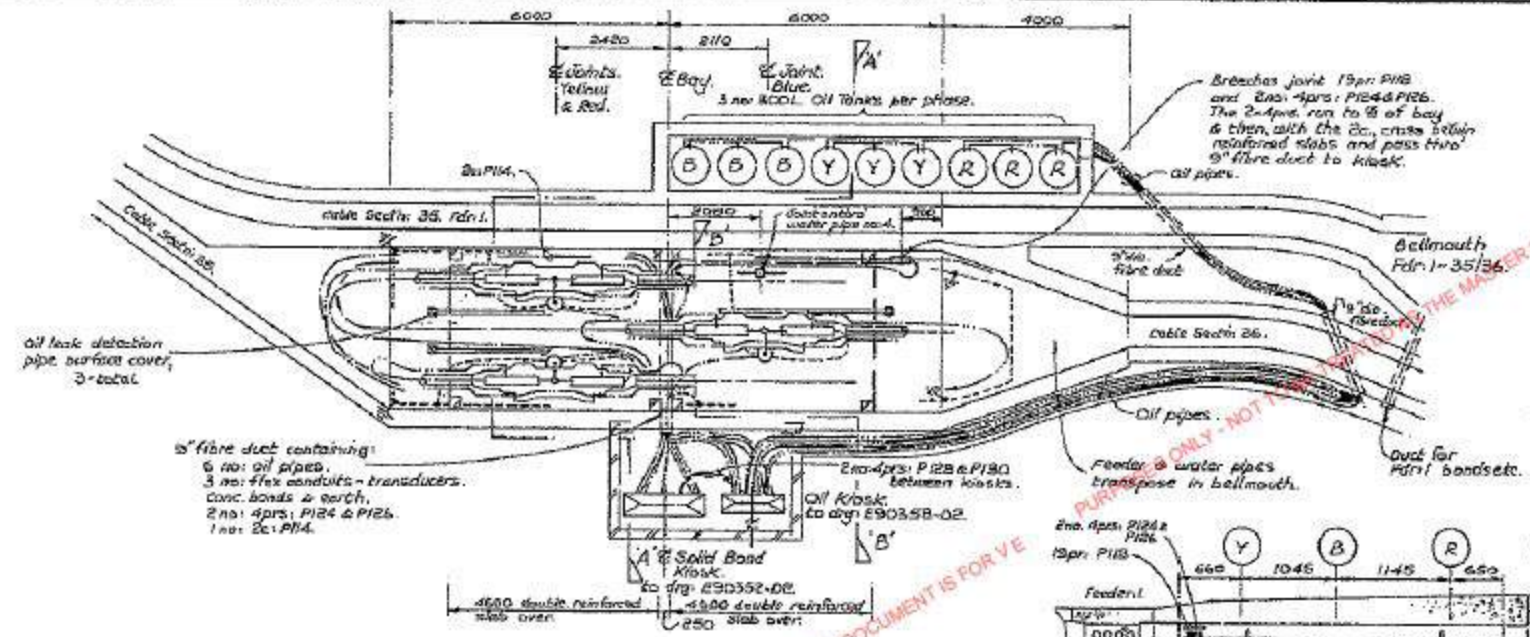

Layout of Stop Joint Bay - 35/36. Feeder-2. Scale - 1:100.

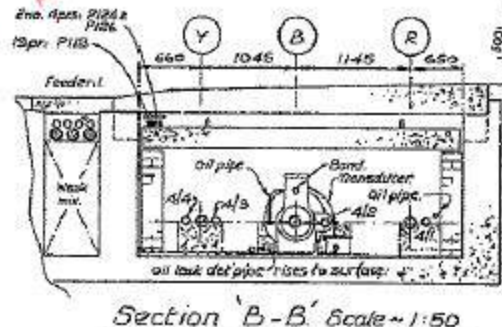

Section B-B' Scale - 1:50

Section A-A' Scale - 1:50  
70/3620 SHT 126  
Jointing Details

Joint	Phase	Type of cable	Jointer	Date
Firelli General Stop Joints to R.C. dry not 661061.	R.	400 kv. S.C. 2000 mm. Oil filled, Lead Sheath.	R.A. Ferryhough.	20-5-80
	Y.		R.A. Ferryhough.	22-5-80
	B.		R.A. Ferryhough.	4-6-80.
19pr. 1/2 2pr. P118.	P118.	19pr. 1/2 2pr. P118. AWA. P118. P124. P126. P128. P130. P132. P134. P136. P138. P140. P142. P144. P146. P148. P150. P152. P154. P156. P158. P160. P162. P164. P166. P168. P170. P172. P174. P176. P178. P180. P182. P184. P186. P188. P190. P192. P194. P196. P198. P200.	M. Gardiner.	11-11-81.

Symbols Key.

	Feeder cable.
	Water pipe.
	Aux. cable.
	Earth.
	Oil pipe.
	Transducer lead.
	Core band.

For additional notes & dimensions refer to Section A-A'

**THIS DOCUMENT IS FOR VIEWING PURPOSES ONLY - NOT TO BE TREATED AS THE MASTER DRAWING**

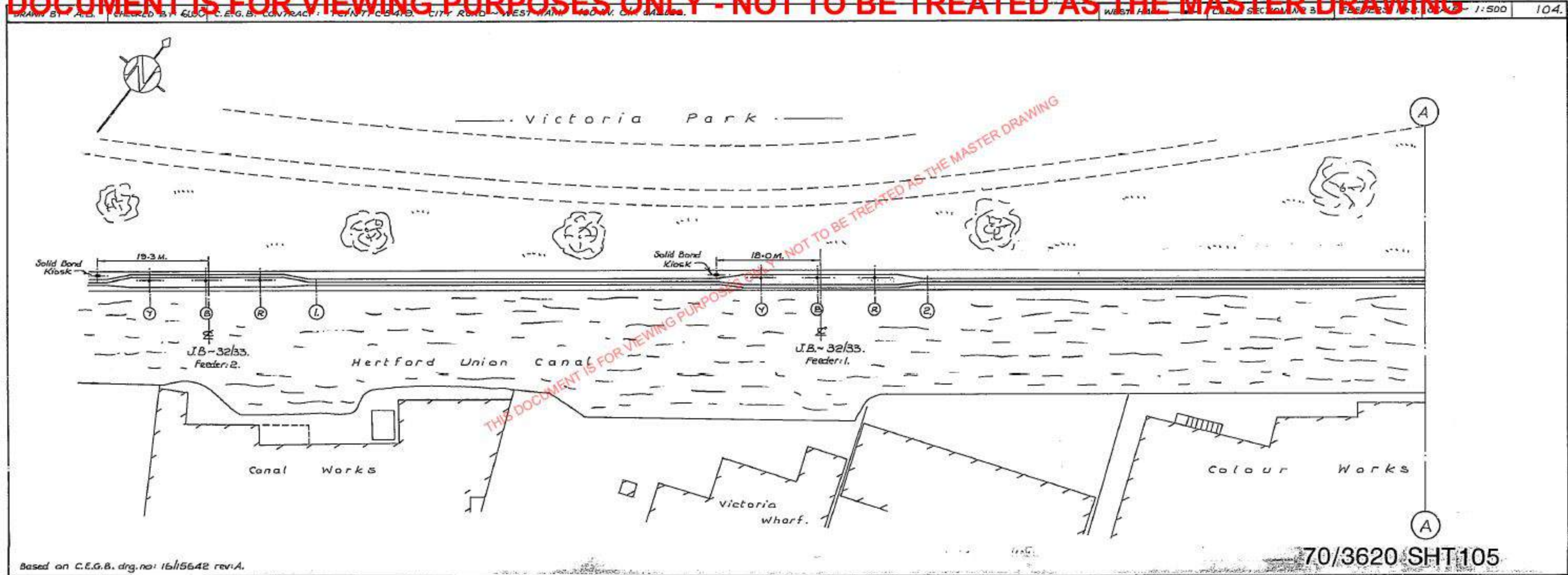

Based on C.E.G.B. drg. no: 16/15642 rev:A.

70/3620 SHT 105

THIS DOCUMENT IS FOR VIEWING PURPOSES ONLY - NOT TO BE TREATED AS THE MASTER DRAWING

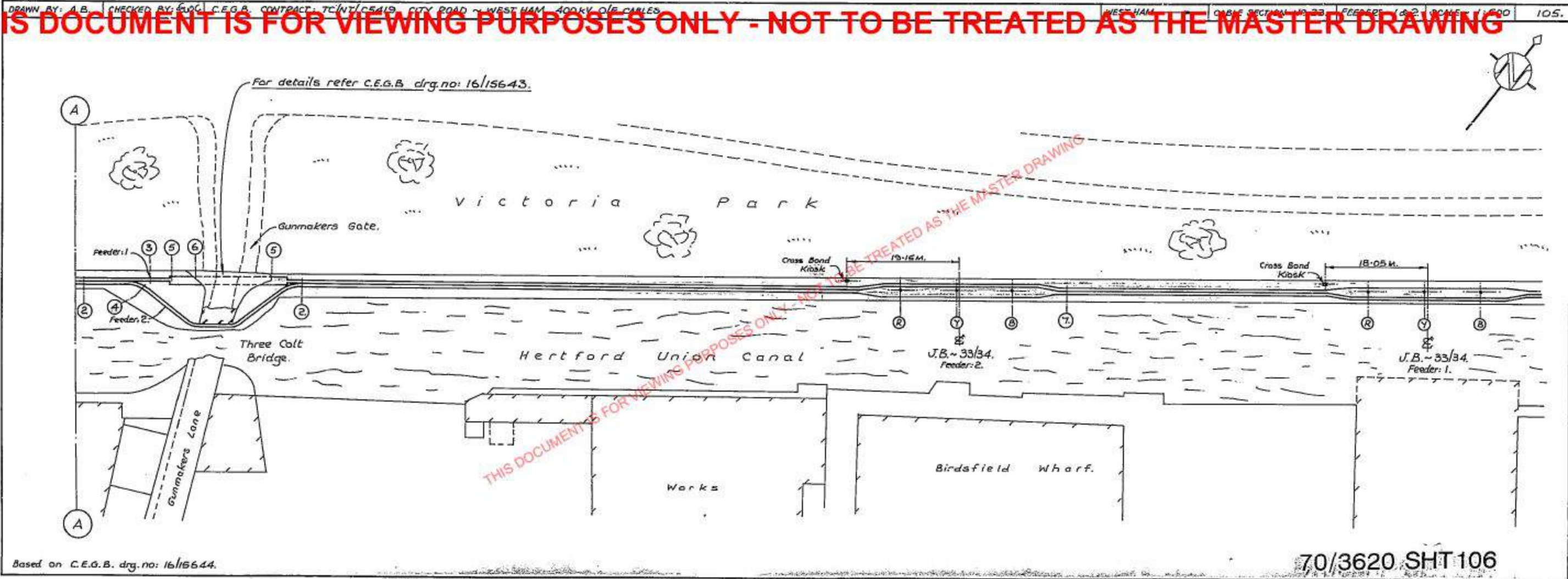

**THIS DOCUMENT IS FOR VIEWING PURPOSES ONLY - NOT TO BE TREATED AS THE MASTER DRAWING**

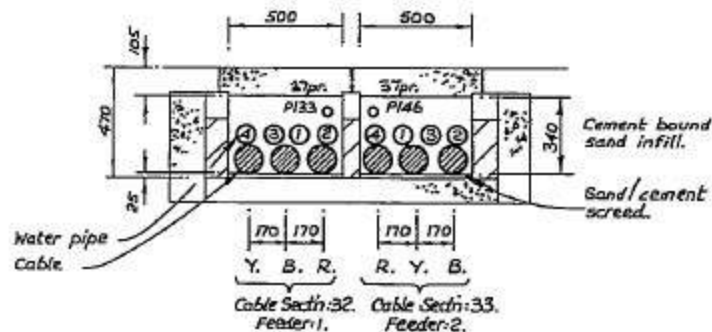

1.

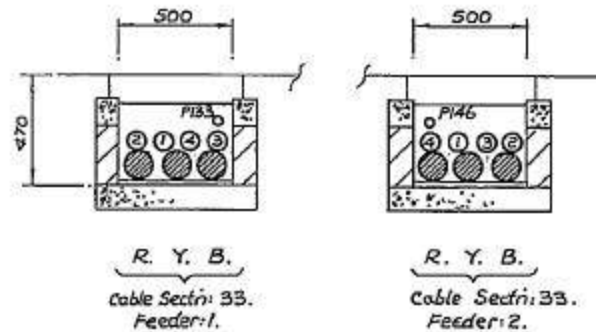

3.

4.

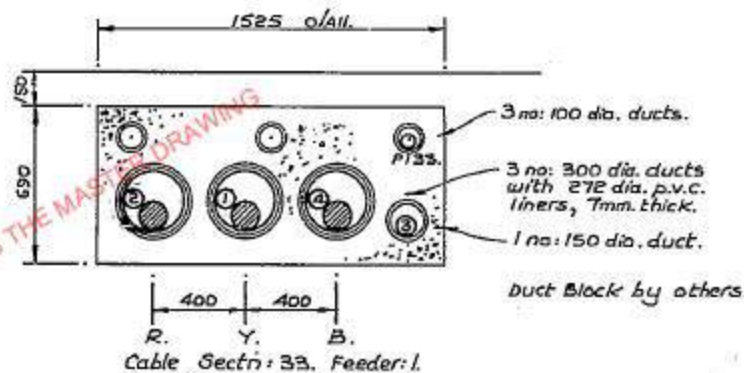

6.

For construction details refer to C.E.G.B. drg. no: 16/15643

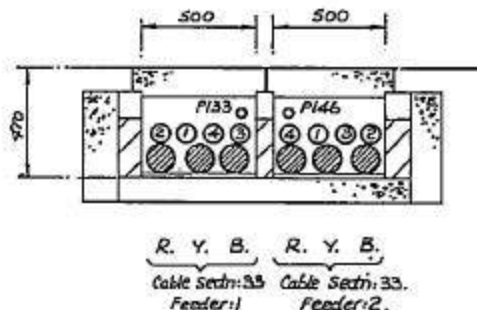

2.

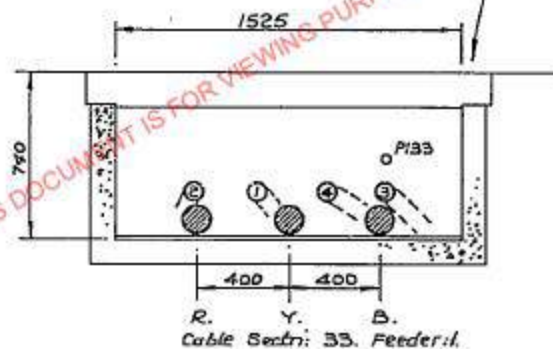

5.

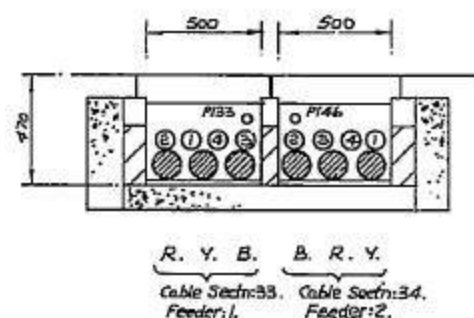

7.

Trough construction & base screed by others.

THIS DOCUMENT IS FOR VIEWING PURPOSES ONLY - NOT TO BE TREATED AS THE MASTER DRAWING

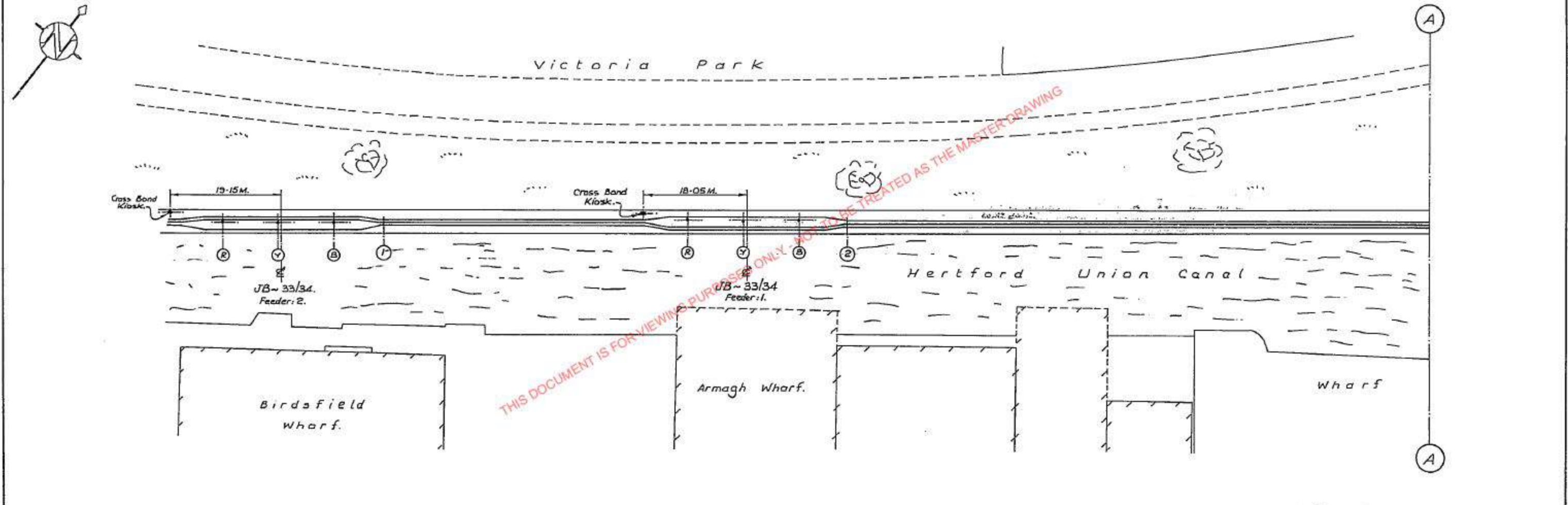

Based on C.E.G.B. drg. no: 16/15644.

70/3620 SHT 110

THIS DOCUMENT IS FOR VIEWING PURPOSES ONLY - NOT TO BE TREATED AS THE MASTER DRAWING

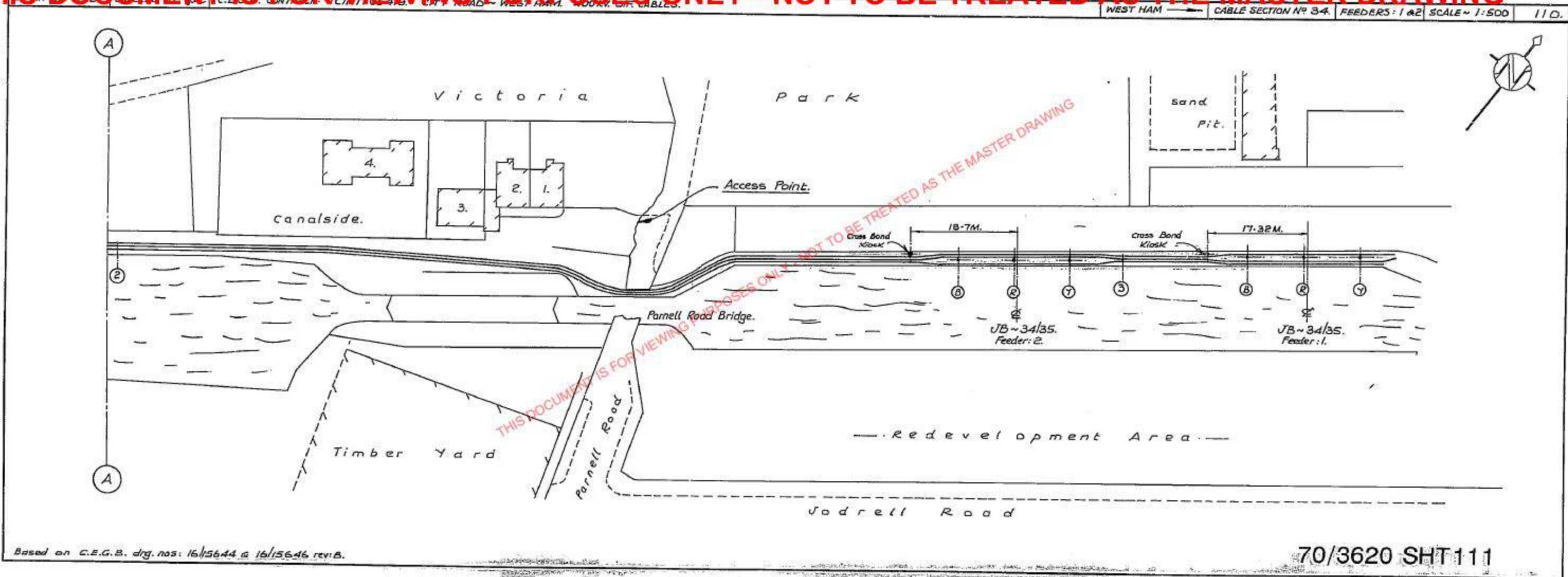

THIS DOCUMENT IS FOR VIEWING PURPOSES ONLY - NOT TO BE TREATED AS THE MASTER DRAWING

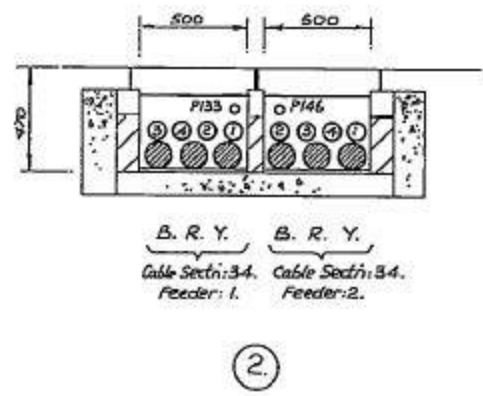
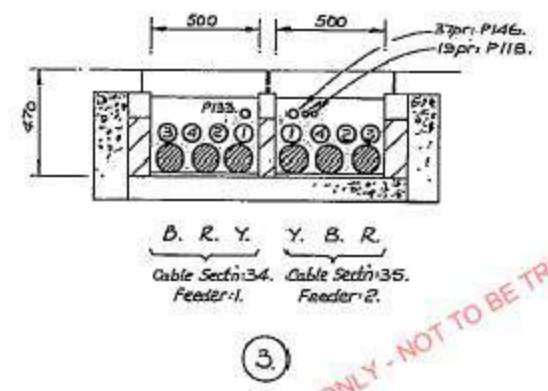
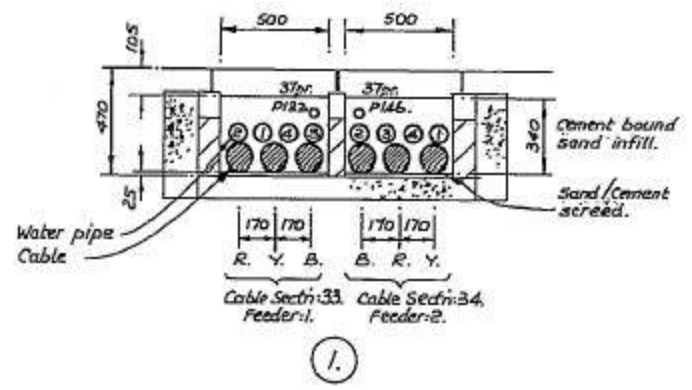

THIS DOCUMENT IS FOR VIEWING PURPOSES ONLY - NOT TO BE TREATED AS THE MASTER DRAWING

Trough construction & base screed by others.

**THIS DOCUMENT IS FOR VIEWING PURPOSES ONLY - NOT TO BE TREATED AS THE MASTER DRAWING**



— Victoria Park —

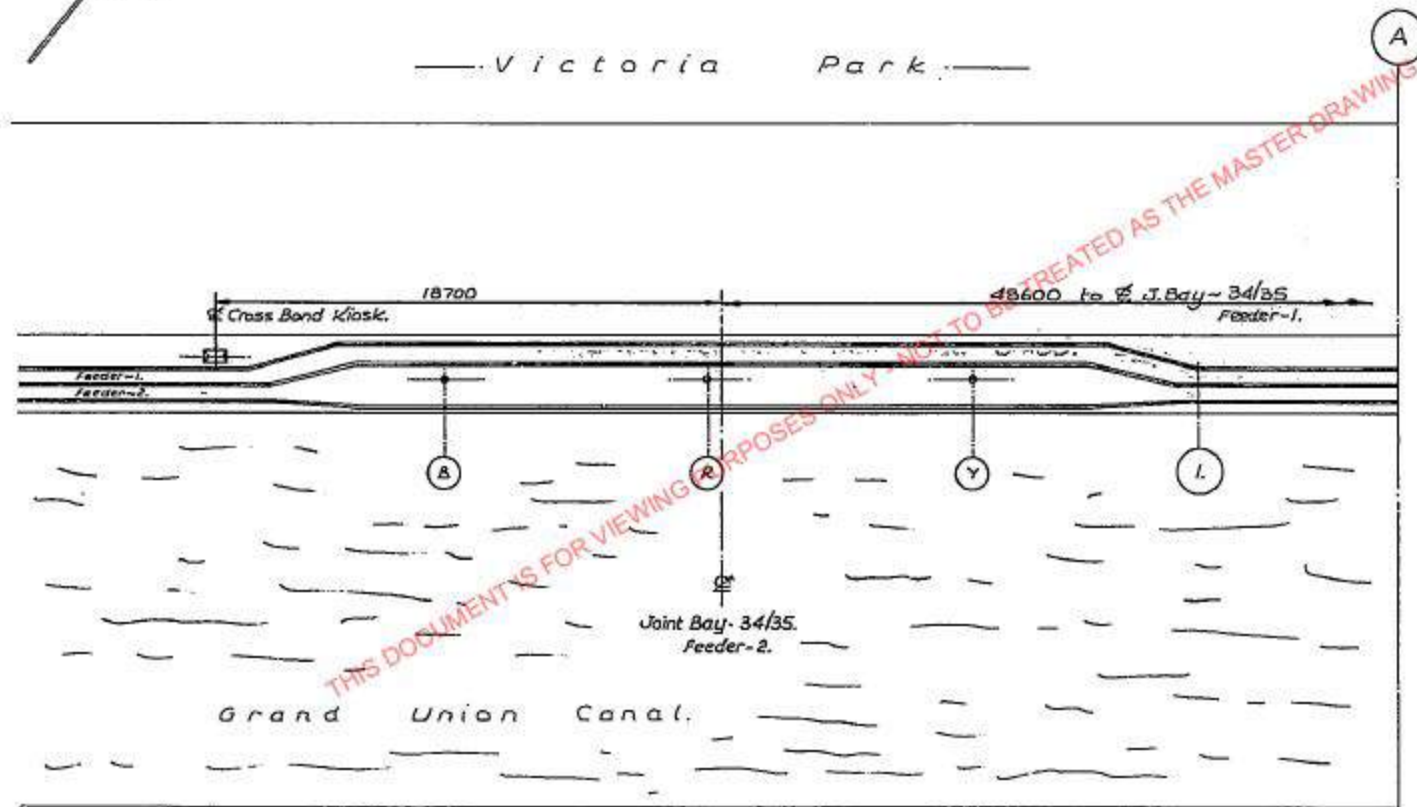

70/3620 SHT:115



**THIS DOCUMENT IS FOR VIEWING PURPOSES ONLY - NOT TO BE TREATED AS THE MASTER DRAWING**

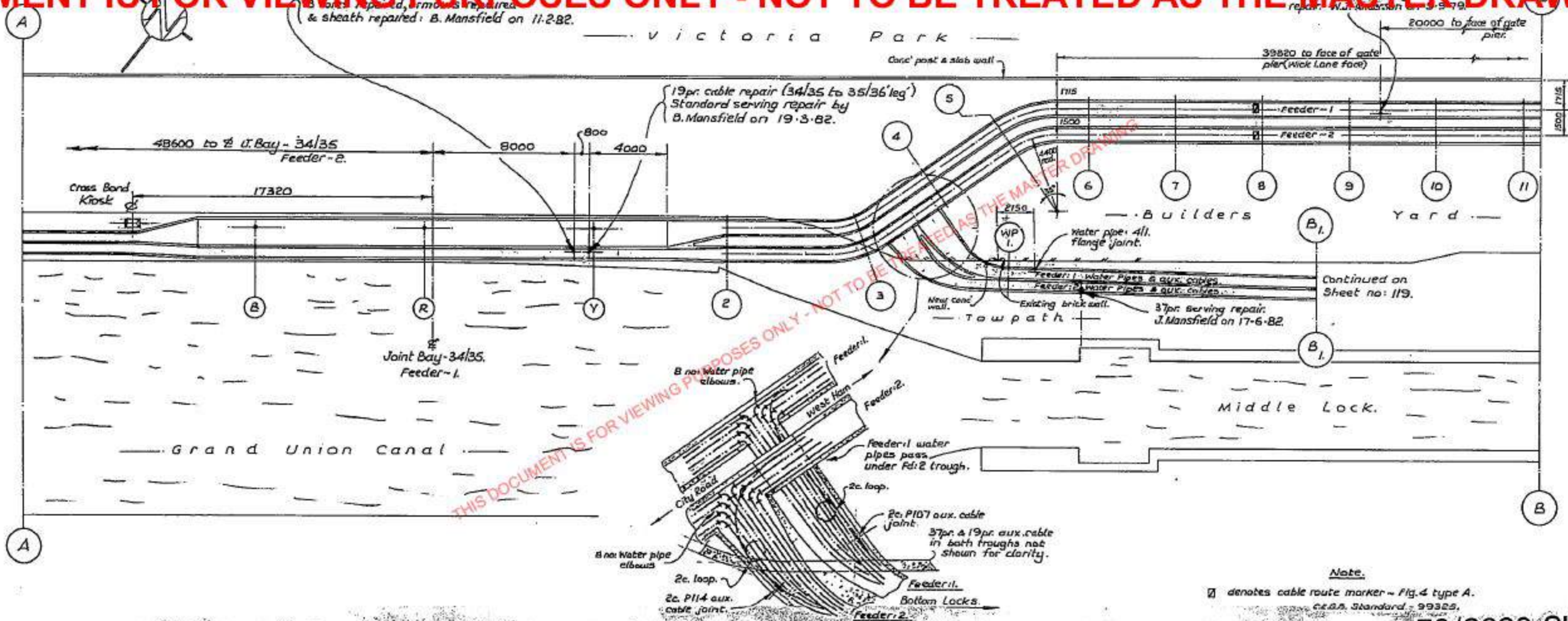

Note:  
□ denotes cable route marker - Fig. 4 type A.  
C.E.G.B. Standard - 99329.

70/3620 SHT 116

THIS DOCUMENT IS FOR VIEWING PURPOSES ONLY - NOT TO BE TREATED AS THE MASTER DRAWING

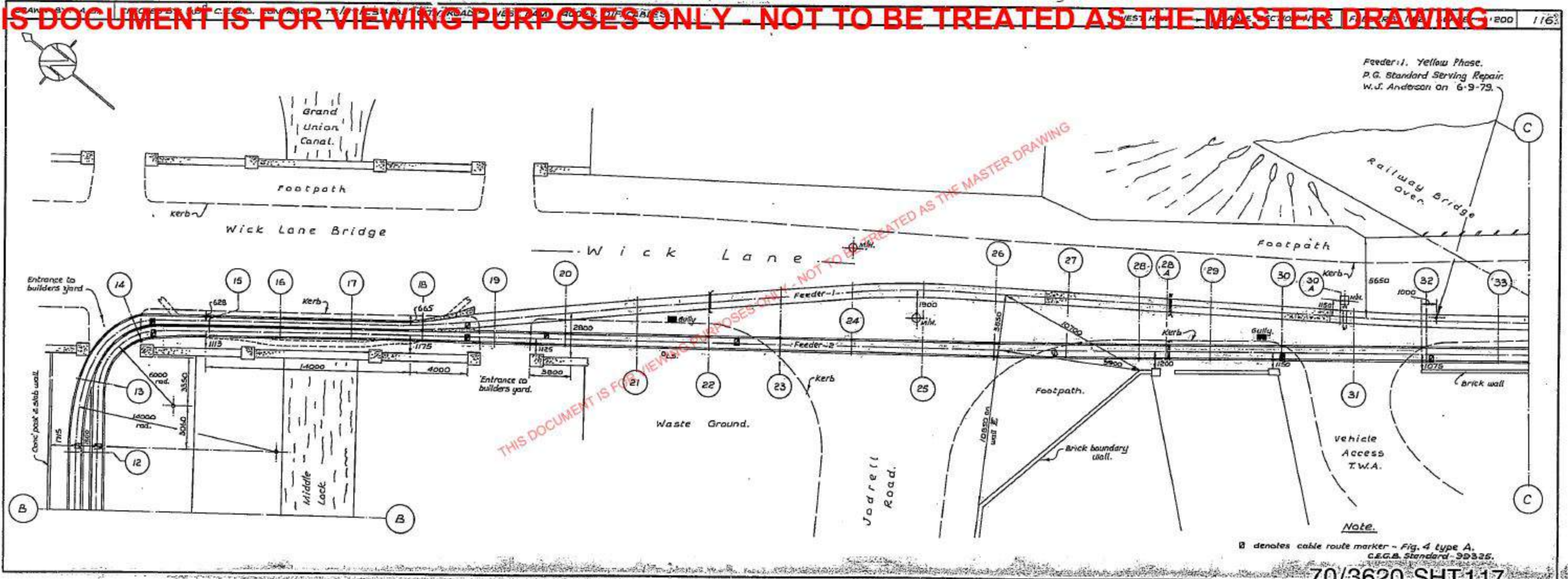

Feeder 1, Yellow Phase.  
P.G. Standard Servicing Repair.  
W.J. Anderson on 6-9-79.

THIS DOCUMENT IS FOR VIEWING PURPOSES ONLY - NOT TO BE TREATED AS THE MASTER DRAWING

THIS DOCUMENT IS FOR VIEWING PURPOSES ONLY - NOT TO BE TREATED AS THE MASTER DRAWING



70/3620 SHT.118

Note:  
□ denotes cable route marker - Fig. 4, type A. C.S.B. Standard - 99325.  
■ denotes cable route marker - L.E.B.

**THIS DOCUMENT IS FOR VIEWING PURPOSES ONLY - NOT TO BE TREATED AS THE MASTER DRAWING**

Feeder-1. Blue phase.  
P.G. Standard Servicing Repair.  
J. Anderson on 10-9-79.

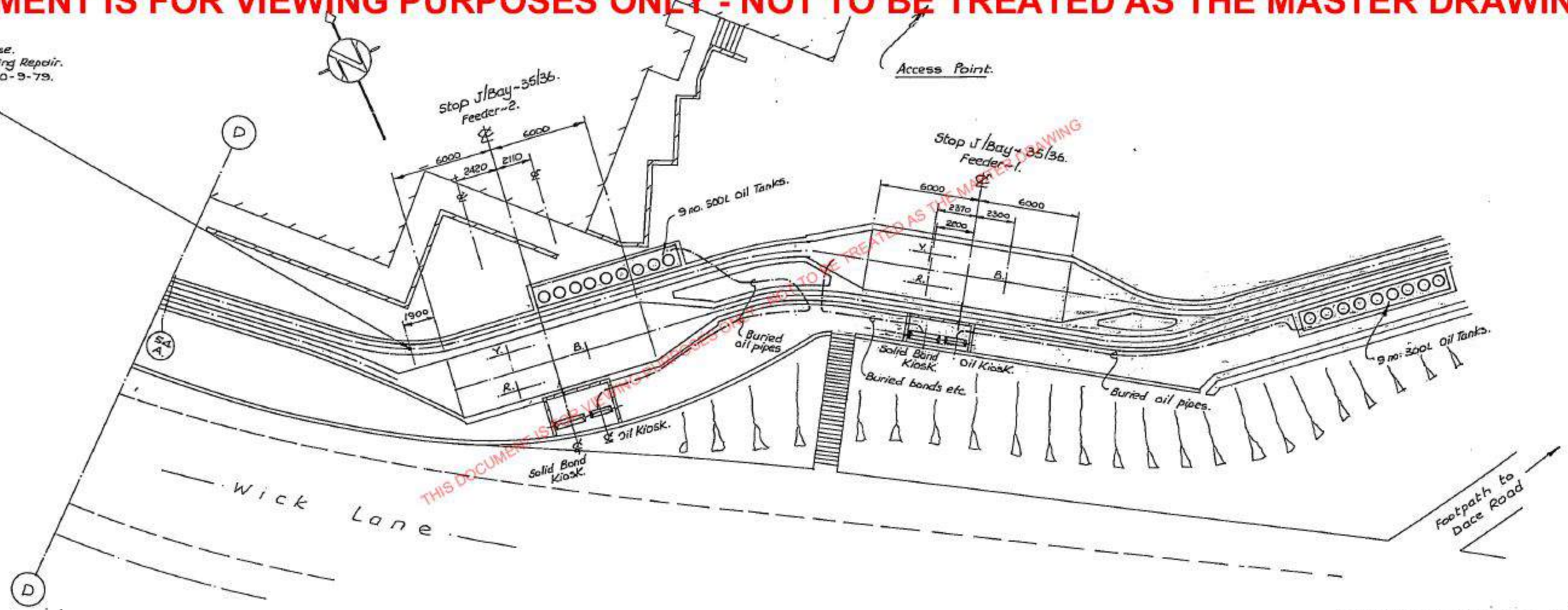

THIS DOCUMENT IS FOR VIEWING PURPOSES ONLY - NOT TO BE TREATED AS THE MASTER DRAWING

**THIS DOCUMENT IS FOR VIEWING PURPOSES ONLY - NOT TO BE TREATED AS THE MASTER DRAWING**

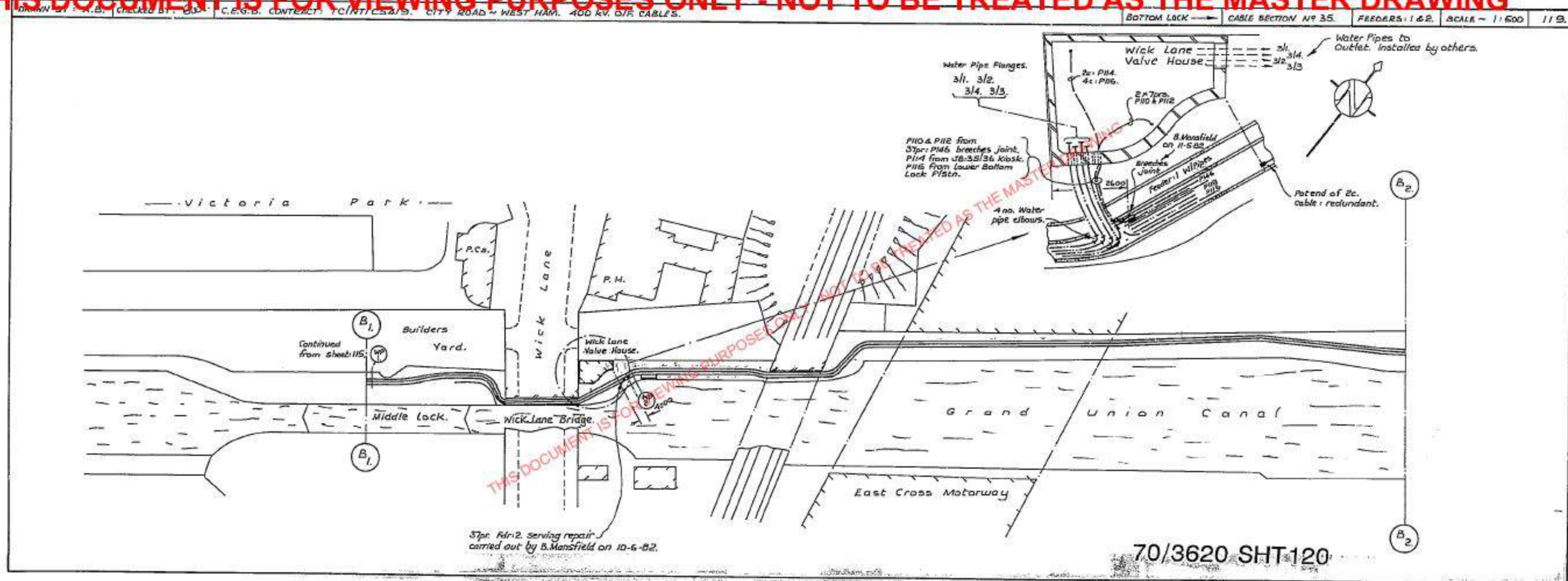

**THIS DOCUMENT IS FOR VIEWING PURPOSES ONLY - NOT TO BE TREATED AS THE MASTER DRAWING**

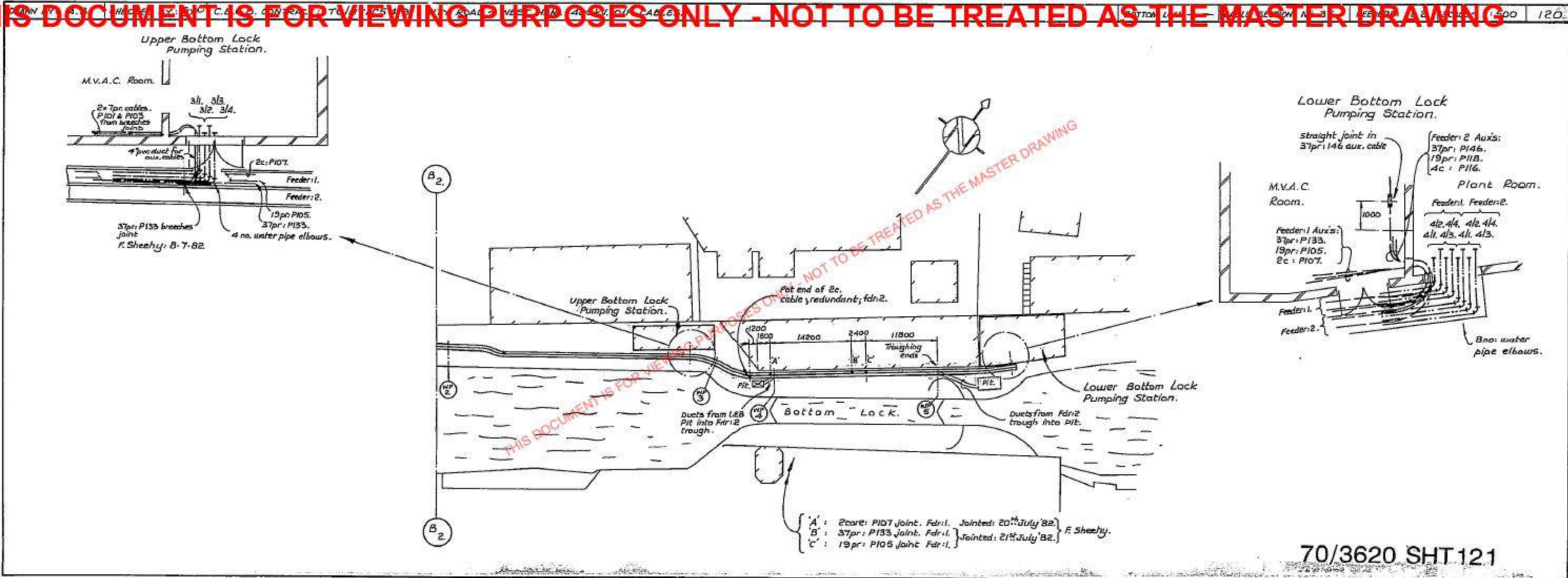

70/3620 SHT 121

THIS DOCUMENT IS FOR VIEWING PURPOSES ONLY - NOT TO BE TREATED AS THE MASTER DRAWING

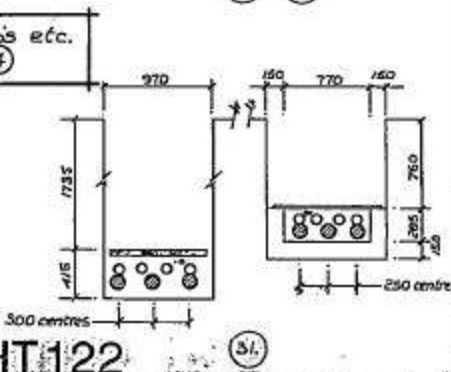
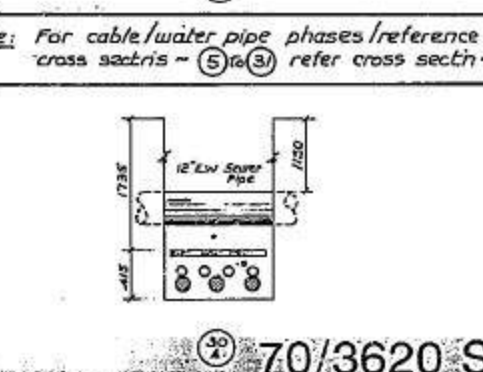
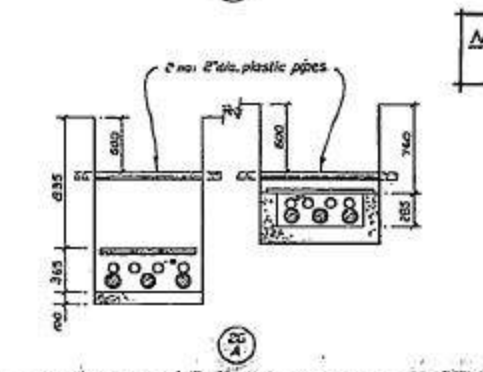
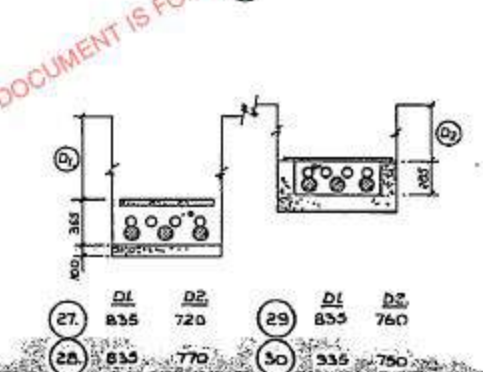
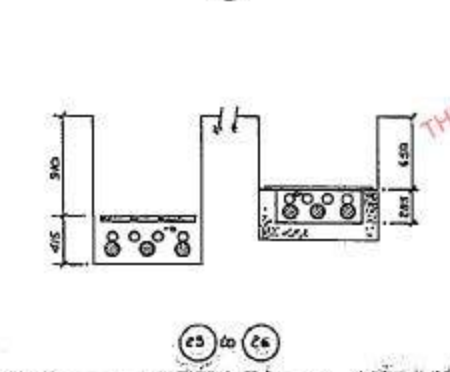
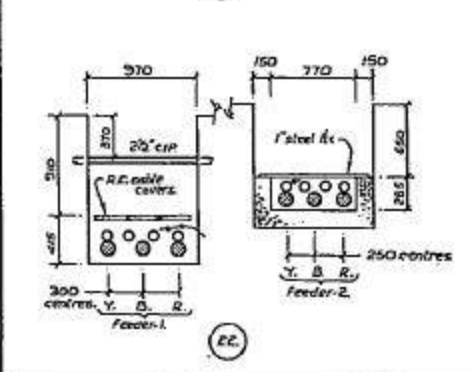
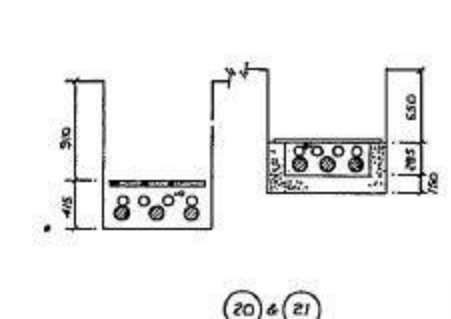
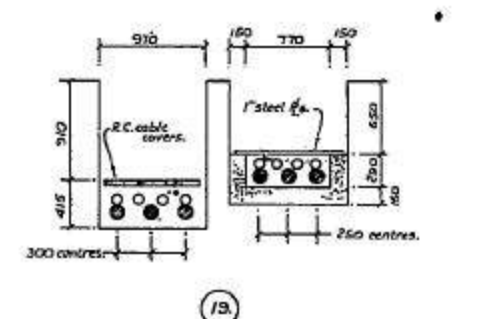
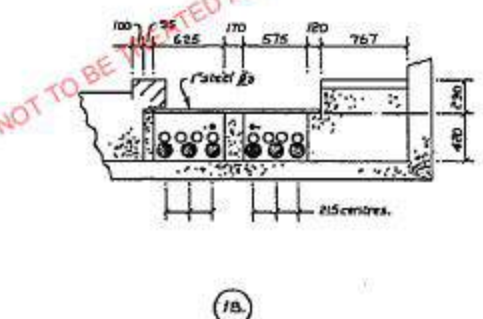
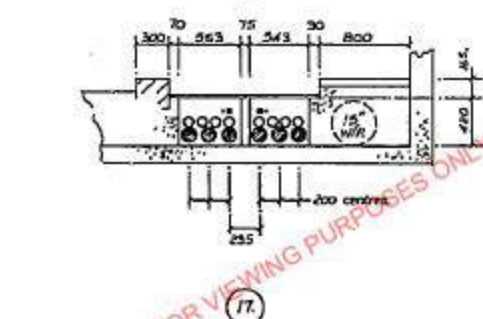
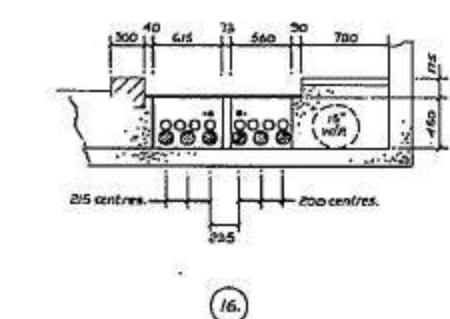
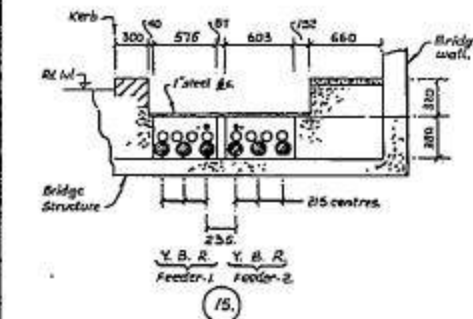
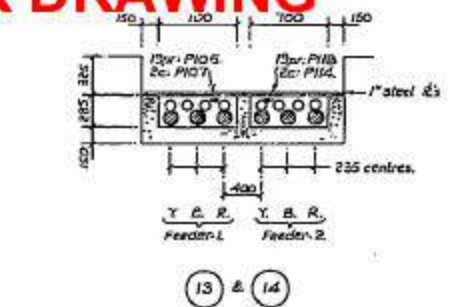
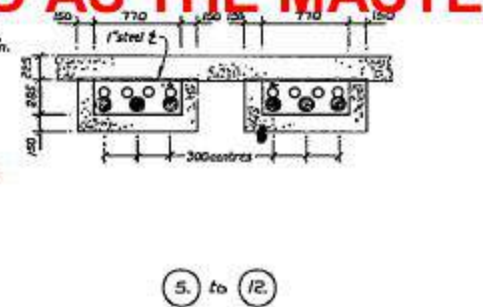
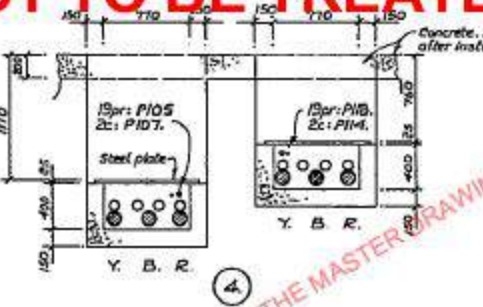
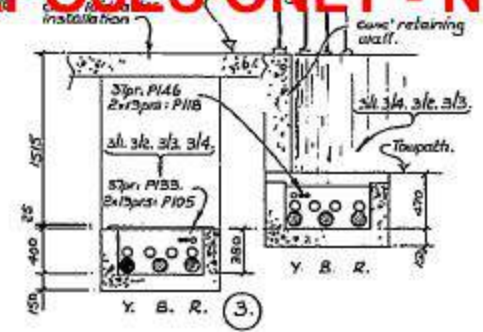
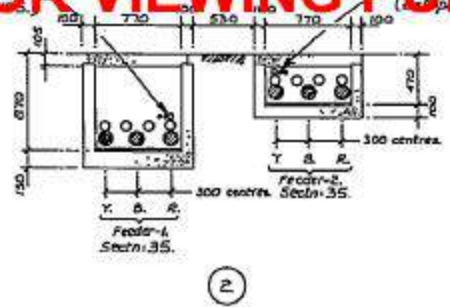
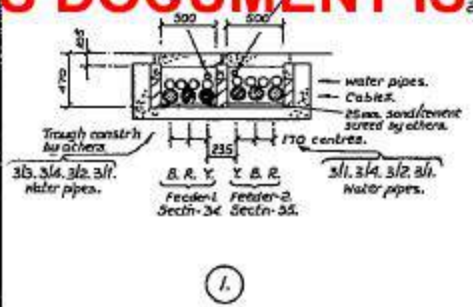

Note: For cable/water pipe phases/reference nos etc. cross sects ~ (5) to (3) refer cross sectn ~ (4)

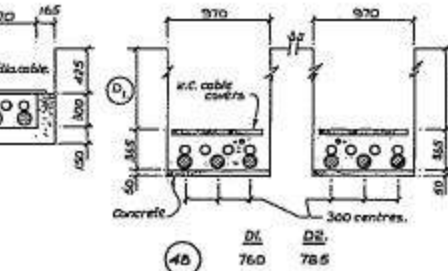
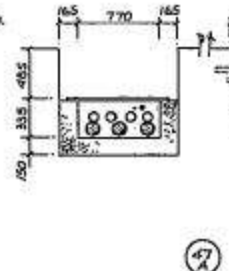
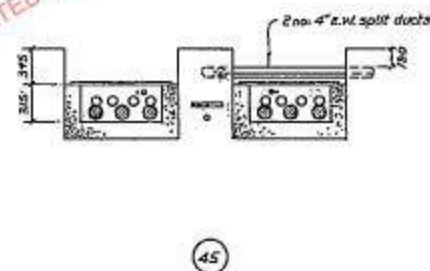
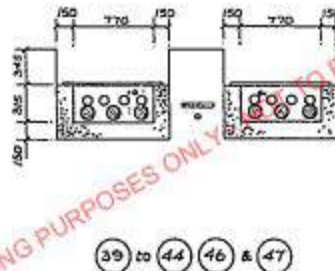
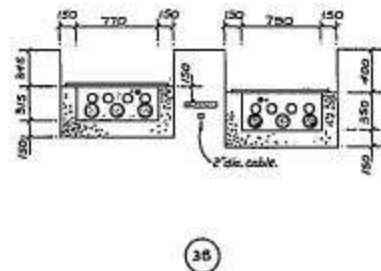
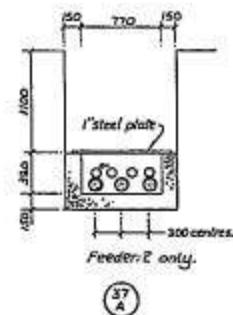
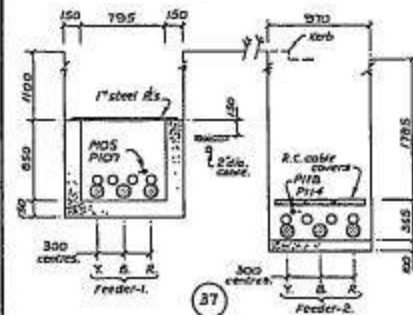
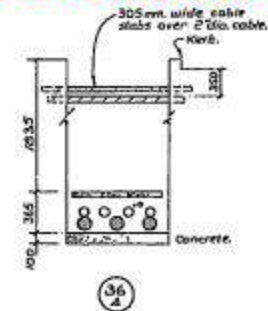
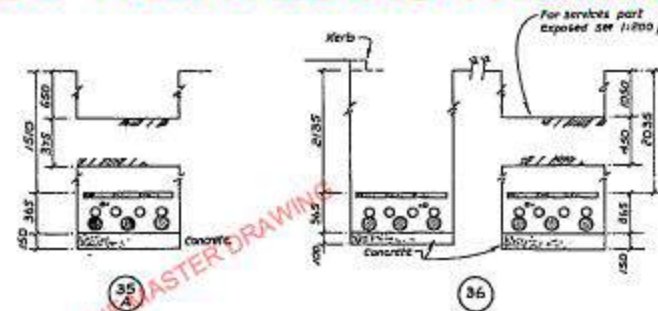
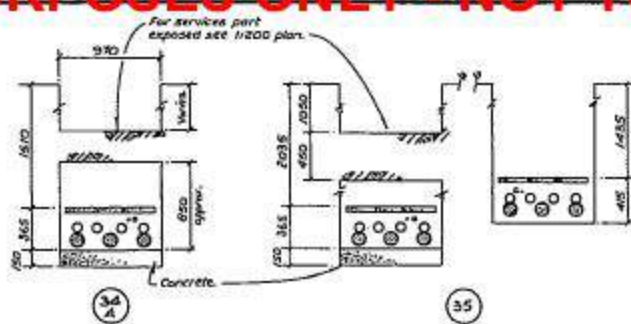
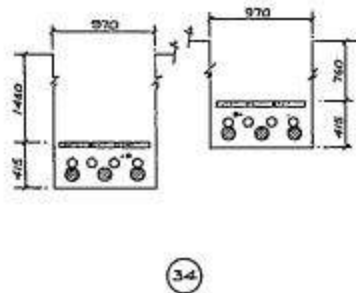
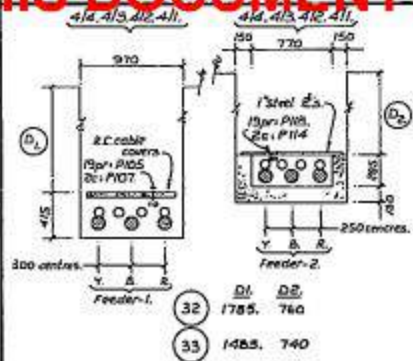

	DL	DS
48	760	785
49	1385	1700
50	1885	2085
51	2685	2685

Note: For cable/water pipe phases/reference no's etc. cross sect'n's ~ 34 to 52 refer cross sect'n ~ 32

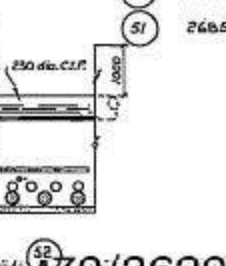
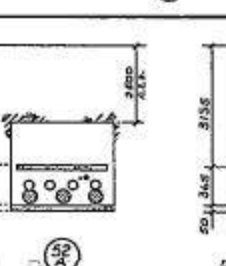
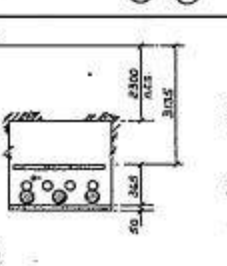
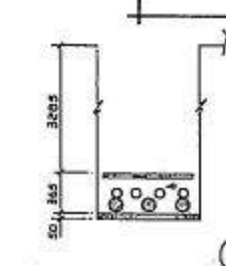
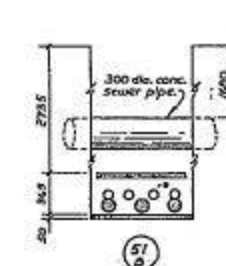
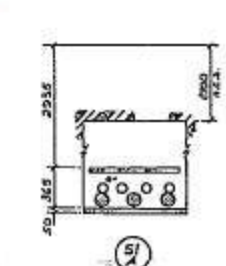
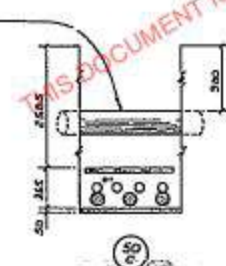
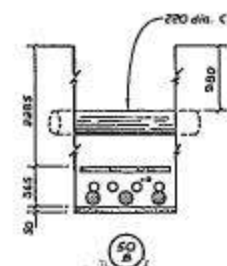
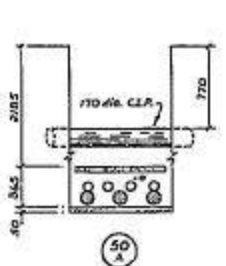
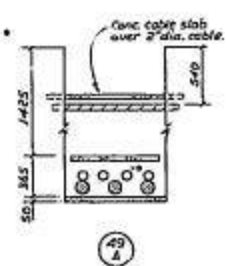



**THIS DOCUMENT IS FOR VIEWING PURPOSES ONLY - NOT TO BE TREATED AS THE MASTER DRAWING**

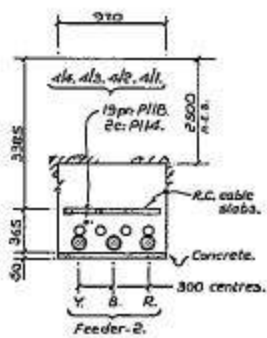

52

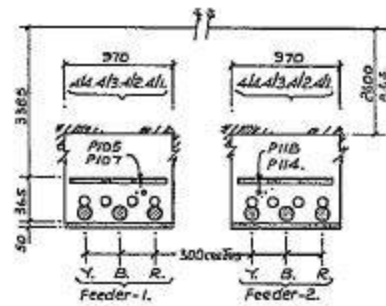

53

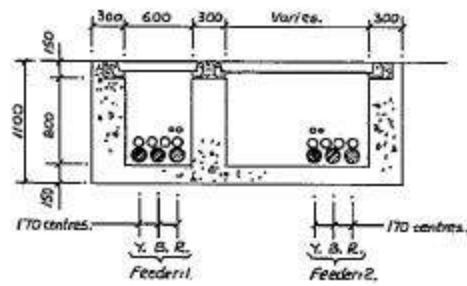

54

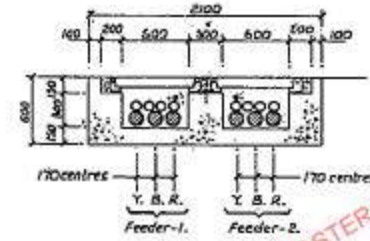

cable / water pipe details  
as cross section: 53

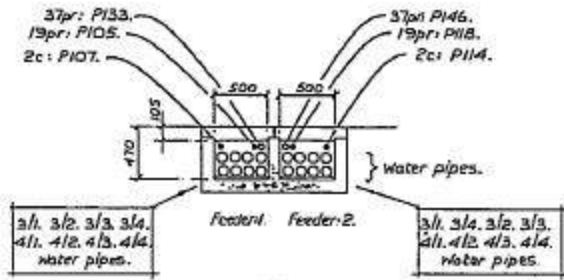

WP 1

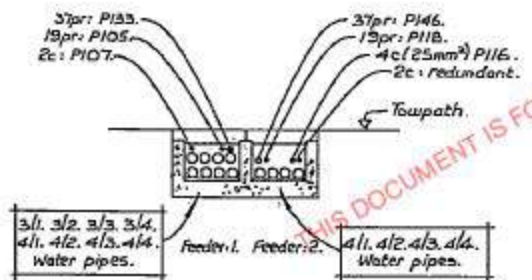

WP 2

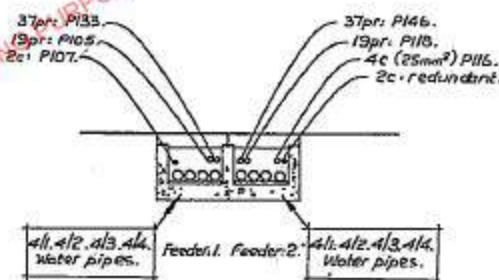

WP 3

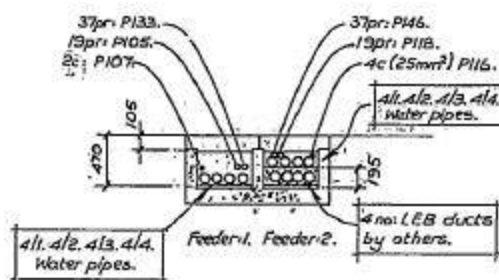

WP 4

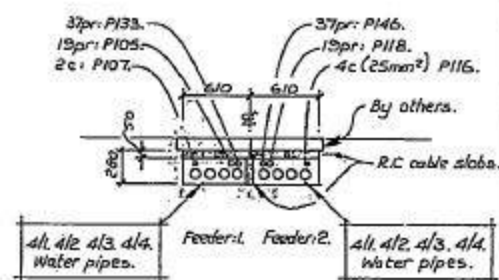

WP 5

cable Troughing etc. for Water Pipe & Aux. cables  
only from Builders Yard to Lower Bottom Lock.

**THIS DOCUMENT IS FOR VIEWING PURPOSES ONLY - NOT TO BE TREATED AS THE MASTER DRAWING**

DRAWN BY: A.B. CHECKED BY: G.W.C. C.E.G.B. CONTRACT: TC/NT/CS419. CITY ROAD - WEST HAM. 400 KV. O/F. CABLES.

WEST HAM → CABLE SECTION NO 36 FEEDERS 1 & 2 SCALE ~ 1:500 126.

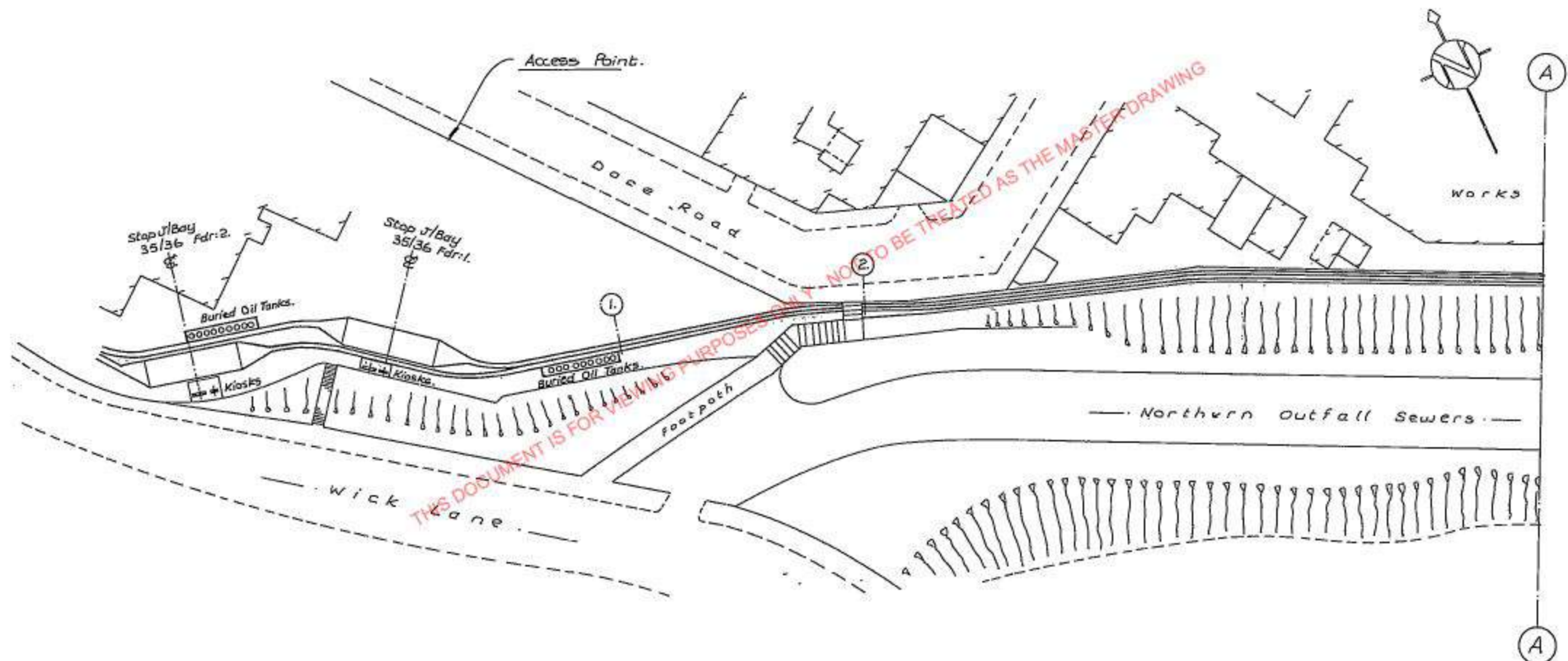

Based on C.E.G.B. dng. no: 16/16321.

70/3620 SHT 127

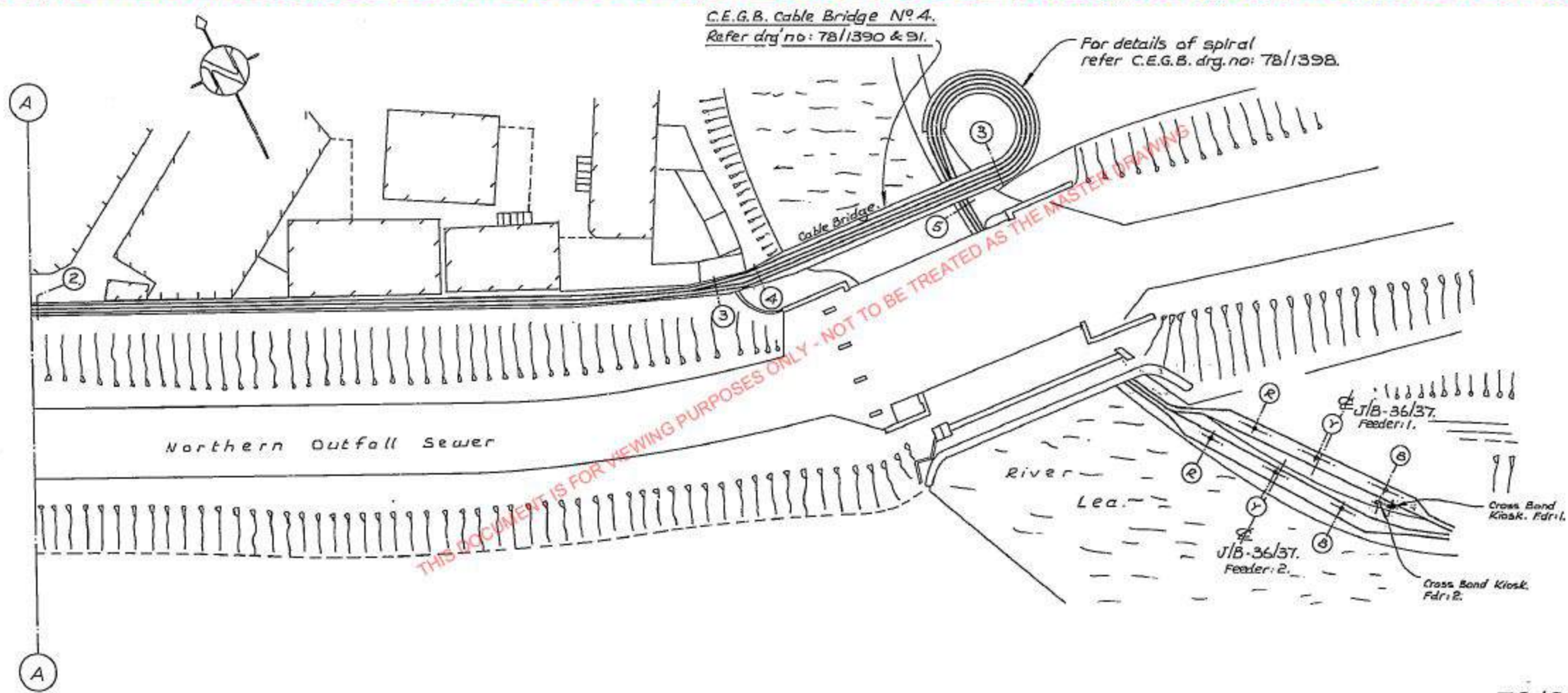

Based on C.E.G.B. drgs: 16/16322 & 16/16321.

70/3620 SHT 128

**THIS DOCUMENT IS FOR VIEWING PURPOSES ONLY - NOT TO BE TREATED AS THE MASTER DRAWING**

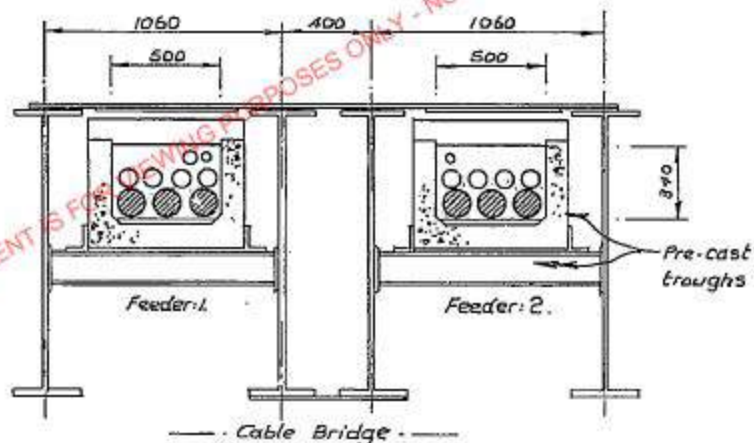
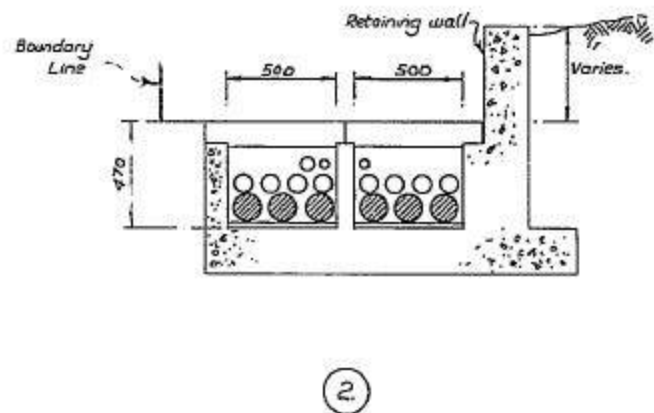
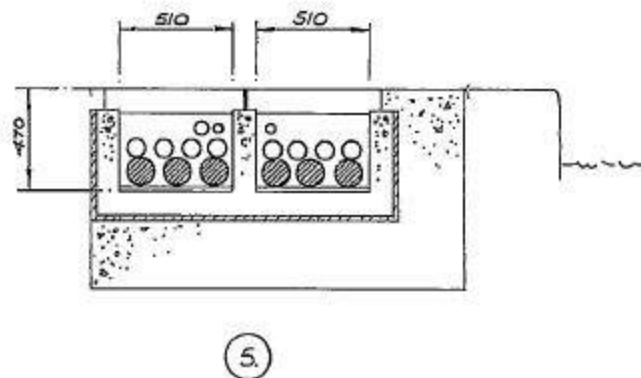
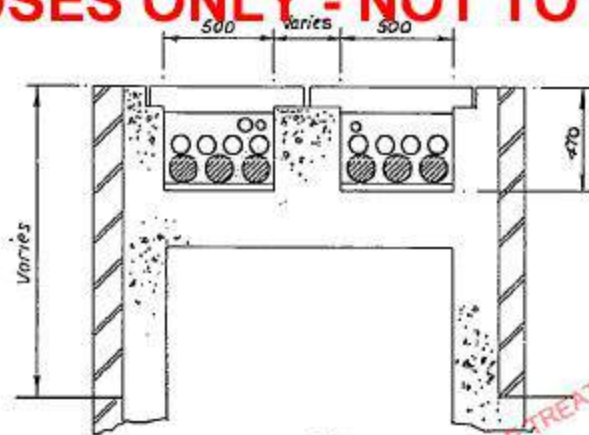
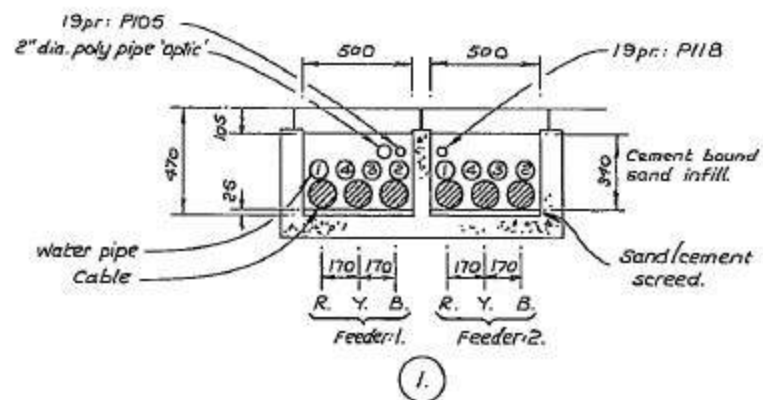

Note: For cable/water pipe phases/reference nos etc on cross sectns ② to ⑤ refer cross sectn: ①

Trough construction & base screed by others.

70/3620 SHT 129

Dear Sir/Madam,

Thank you for submitting your recent plant enquiry.

Based on the information provided, I can confirm that Energetics **does not** have any plant within the area(s) specified in your request.

Please be advised that it may take around 10 working days to process enquiries. In the unlikely event that you have been waiting longer than 10 working days, or require further assistance with outstanding enquiries, please call.

Please ensure all plant enquiries are sent to

Regards

**From:** utility.reports@emapsite.com [mailto:utility.reports@emapsite.com]

**Sent:** 11 March 2015 10:26

**To:** Plant Enquiries

**Subject:** Plant Location Request EMS00347 Site at GROWING CONCERNS GARDEN CENTRE, 2, WICK LANE, N/A, N/A, E3 2NA

**RE: GROWING CONCERNS GARDEN CENTRE, 2, WICK LANE, N/A, N/A, E3 2NA**

**Location: OSGB: 536905.000,184116.200**

**Our Reference: EMS00347**

## Utility Reports

---

**From:**  
**Sent:**  
**To:**  
**Subject:**  
**Attachments:**

24/03/2015

LinesearchbeforeUdig Ref: 6601423  
Your Ref: EMS00347

Dear Sir/Madam,

Further to your enquiry received on 24/03/2015 09:19:12 AM please find attached the ESP Utilities Group (ESP) response to your enquiry.

If your proposed work site was found to be in the vicinity of ESP plant, project drawing as laid extracts for these sites are enclosed (not to scale) for your information which show the approximate location of the ESP gas network close to the area of interest.

As your plans for the proposed work develop you are required to keep ESP regularly updated about the extent and nature of your proposed works in order for us to fully establish whether any additional precautionary or diversionary works are necessary to protect our gas network.

Arrangements can be set in place so that one of our representatives can meet on site (date to be agreed) and we will be happy to discuss the impact of your proposals on the gas network once we have received the details.

ESP are continually constructing new gas and electricity networks and this notification is valid for 90 days from the date of this letter. If your proposed works start after this period of time, please re-submit your linesearchbeforeUdig enquiry.

The attached files are in PDF format, to view them you will need Adobe Acrobat Reader(R). You can download it free of charge from <http://get.adobe.com/reader>

# Overview

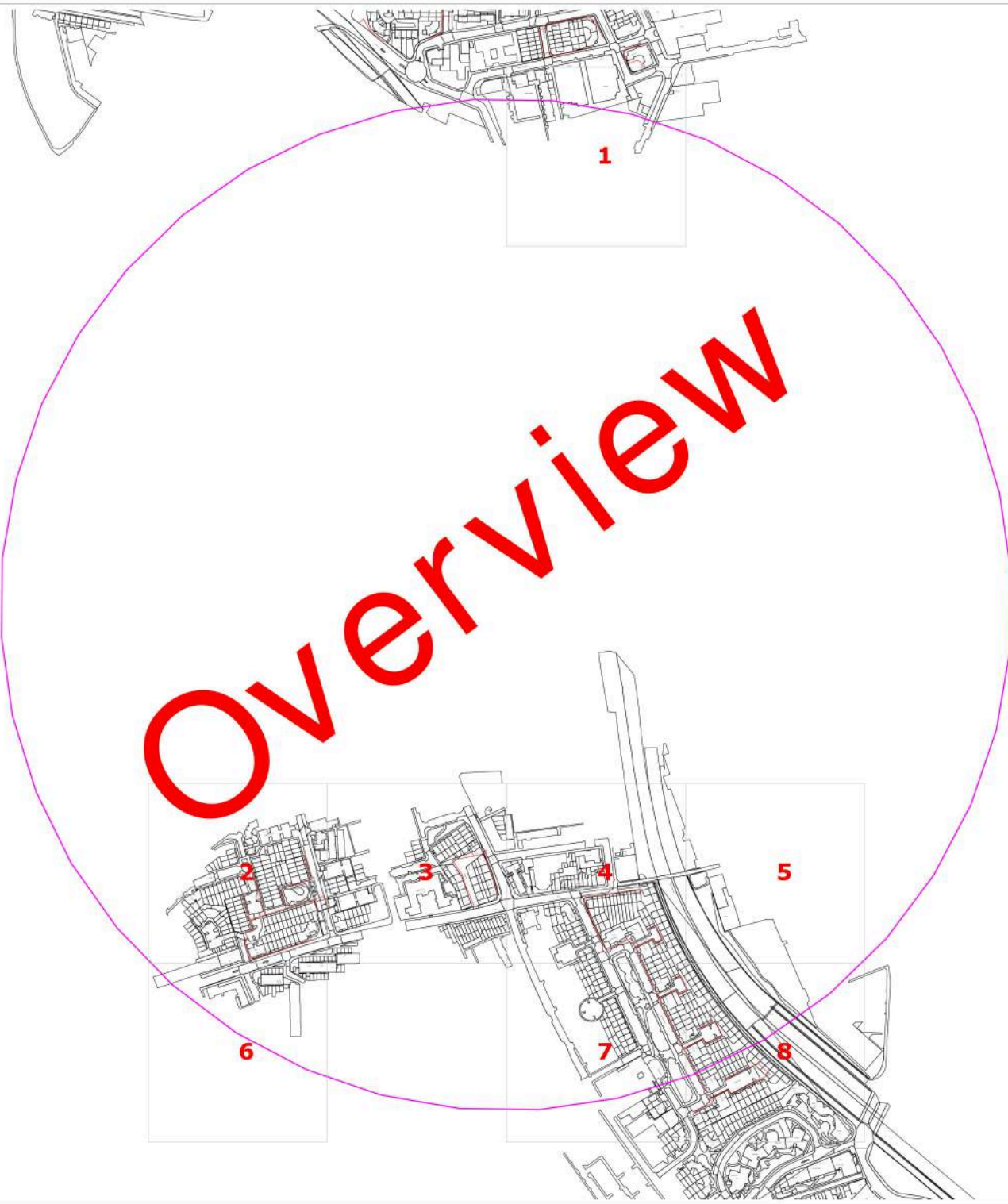



Date Requested: 24/03/2015  
 Requested by: Stephen Sawyer  
 Job Reference: 6601423

Company: Technics Group  
 Your Scheme/Reference: EMS00347





### Key for Mains & Service Pipework

-  Existing LP mains or services operating up to 75 millibar gauge
-  Existing MP mains or services operating between 75 millibar and 2 bar gauge
-  Existing IP mains or services operating between 2 bar and 7 bar gauge

Whilst ESP Utilities Group Ltd (ESP) try to ensure the asset information we provide is accurate, the information is provided Without Prejudice and ESP accept no liability for claims arising from any inaccuracy, omissions or errors contained in this response. The actual position of underground services must be verified and established on site before any mechanical plant is used. Authorities and contractors will be held liable for the full cost of repairs to ESP apparatus and all claims made against them by Third parties as a result of any interference or damage.

REPRODUCED FROM THE ORDNANCE SURVEY MAP WITH THE SANCTION OF THE CONTROLLER OF HER MAJESTY'S STATIONARY OFFICE © CROWN COPYRIGHT RESERVED.  
 THIS DRAWING IS THE COPYRIGHT OF ES PIPELINES LIMITED AND MAY NOT BE REPRODUCED WITHOUT WRITTEN CONSENT ©

Dig Sites:  
 Area  Line   
 Approx scale on A4 paper: 1:1000  
 (excluding Overview map)



Date Requested: 24/03/2015  
 Requested by: Stephen Sawyer  
 Job Reference: 6601423

Company: Technics Group  
 Your Scheme/Reference: EMS00347

**Key for Mains & Service Pipework**



Existing LP mains or services operating up to 75 millibar gauge



Existing MP mains or services operating between 75 millibar and 2 bar gauge





Existing IP mains or services operating between 2 bar and 7 bar gauge



Whilst ESP Utilities Group Ltd (ESP) try to ensure the asset information we provide is accurate, the information is provided Without Prejudice and ESP accept no liability for claims arising from any inaccuracy, omissions or errors contained in this response. The actual position of underground services must be verified and established on site before any mechanical plant is used. Authorities and contractors will be held liable for the full cost of repairs to ESP apparatus and all claims made against them by Third parties as a result of any interference or damage.

REPRODUCED FROM THE ORDNANCE SURVEY MAP WITH THE SANCTION OF THE CONTROLLER OF HER MAJESTY'S STATIONARY OFFICE © CROWN COPYRIGHT RESERVED.  
 THIS DRAWING IS THE COPYRIGHT OF ES PIPELINES LIMITED AND MAY NOT BE REPRODUCED WITHOUT WRITTEN CONSENT ©

Dig Sites:  
 Area  Line   
 Approx scale on A4 paper: 1:1000  
 (excluding Overview map)



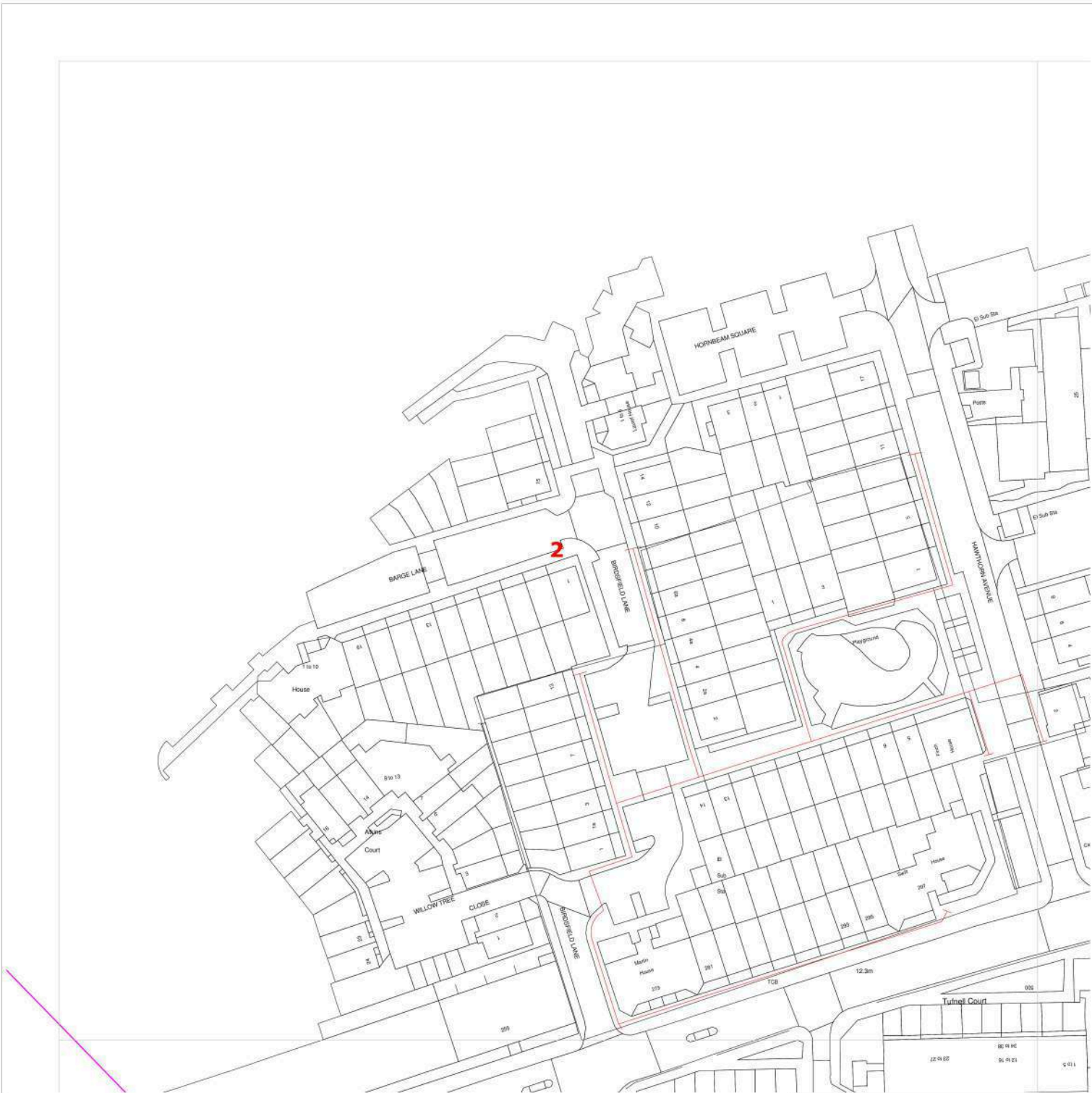



Date Requested: 24/03/2015  
 Requested by: Stephen Sawyer  
 Job Reference: 6601423

Company: Technics Group  
 Your Scheme/Reference: EMS00347



**Key for Mains & Service Pipework**

-  Existing LP mains or services operating up to 75 millibar gauge
-  Existing MP mains or services operating between 75 millibar and 2 bar gauge
-  Existing IP mains or services operating between 2 bar and 7 bar gauge



Whilst ESP Utilities Group Ltd (ESP) try to ensure the asset information we provide is accurate, the information is provided Without Prejudice and ESP accept no liability for claims arising from any inaccuracy, omissions or errors contained in this response. The actual position of underground services must be verified and established on site before any mechanical plant is used. Authorities and contractors will be held liable for the full cost of repairs to ESP apparatus and all claims made against them by Third parties as a result of any interference or damage.

REPRODUCED FROM THE ORDNANCE SURVEY MAP WITH THE SANCTION OF THE CONTROLLER OF HER MAJESTY'S STATIONARY OFFICE © CROWN COPYRIGHT RESERVED.  
 THIS DRAWING IS THE COPYRIGHT OF ES PIPELINES LIMITED AND MAY NOT BE REPRODUCED WITHOUT WRITTEN CONSENT ©

Dig Sites:  
 Area  Line   
 Approx scale on A4 paper: 1:1000  
 (excluding Overview map)



Date Requested: 24/03/2015  
 Requested by: Stephen Sawyer  
 Job Reference: 6601423

Company: Technics Group  
 Your Scheme/Reference: EMS00347

**Key for Mains & Service Pipework**



Existing LP mains or services operating up to 75 millibar gauge

Existing MP mains or services operating between 75 millibar and 2 bar gauge

Existing IP mains or services operating between 2 bar and 7 bar gauge



Whilst ESP Utilities Group Ltd (ESP) try to ensure the asset information we provide is accurate, the information is provided Without Prejudice and ESP accept no liability for claims arising from any inaccuracy, omissions or errors contained in this response. The actual position of underground services must be verified and established on site before any mechanical plant is used. Authorities and contractors will be held liable for the full cost of repairs to ESP apparatus and all claims made against them by Third parties as a result of any interference or damage.

REPRODUCED FROM THE ORDNANCE SURVEY MAP WITH THE SANCTION OF THE CONTROLLER OF HER MAJESTY'S STATIONARY OFFICE © CROWN COPYRIGHT RESERVED.  
 THIS DRAWING IS THE COPYRIGHT OF ES PIPELINES LIMITED AND MAY NOT BE REPRODUCED WITHOUT WRITTEN CONSENT ©

Dig Sites:

Area Line

Approx scale on A4 paper: 1:1000  
 (excluding Overview map)



Date Requested: 24/03/2015  
 Requested by: Stephen Sawyer  
 Job Reference: 6601423

Company: Technics Group  
 Your Scheme/Reference: EMS00347

**Key for Mains & Service Pipework**



Existing LP mains or services operating up to 75 millibar gauge



Existing MP mains or services operating between 75 millibar and 2 bar gauge



Existing IP mains or services operating between 2 bar and 7 bar gauge



Whilst ESP Utilities Group Ltd (ESP) try to ensure the asset information we provide is accurate, the information is provided Without Prejudice and ESP accept no liability for claims arising from any inaccuracy, omissions or errors contained in this response. The actual position of underground services must be verified and established on site before any mechanical plant is used. Authorities and contractors will be held liable for the full cost of repairs to ESP apparatus and all claims made against them by Third parties as a result of any interference or damage.

REPRODUCED FROM THE ORDNANCE SURVEY MAP WITH THE SANCTION OF THE CONTROLLER OF HER MAJESTY'S STATIONARY OFFICE © CROWN COPYRIGHT RESERVED.  
 THIS DRAWING IS THE COPYRIGHT OF ES PIPELINES LIMITED AND MAY NOT BE REPRODUCED WITHOUT WRITTEN CONSENT ©

Dig Sites:  
 Area Line   
 Approx scale on A4 paper: 1:1000  
 (excluding Overview map)



Date Requested: 24/03/2015  
 Requested by: Stephen Sawyer  
 Job Reference: 6601423

Company: Technics Group  
 Your Scheme/Reference: EMS00347



**Key for Mains & Service Pipework**



Existing LP mains or services operating up to 75 millibar gauge





Existing MP mains or services operating between 75 millibar and 2 bar gauge



Existing IP mains or services operating between 2 bar and 7 bar gauge

Whilst ESP Utilities Group Ltd (ESP) try to ensure the asset information we provide is accurate, the information is provided Without Prejudice and ESP accept no liability for claims arising from any inaccuracy, omissions or errors contained in this response. The actual position of underground services must be verified and established on site before any mechanical plant is used. Authorities and contractors will be held liable for the full cost of repairs to ESP apparatus and all claims made against them by Third parties as a result of any interference or damage.

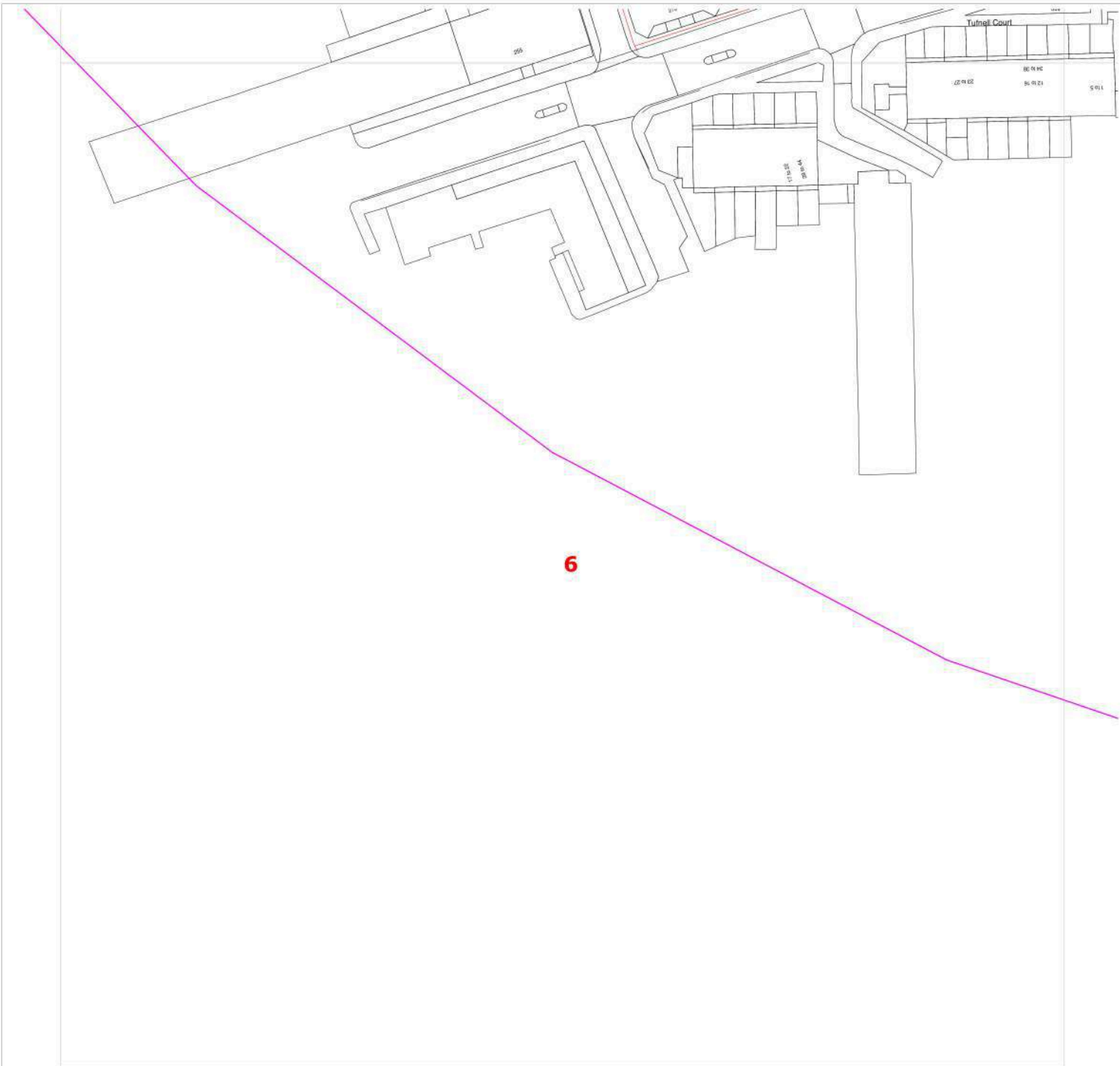

**REPRODUCED FROM THE ORDNANCE SURVEY MAP WITH THE SANCTION OF THE CONTROLLER OF HER MAJESTY'S STATIONARY OFFICE © CROWN COPYRIGHT RESERVED.**  
**THIS DRAWING IS THE COPYRIGHT OF ES PIPELINES LIMITED AND MAY NOT BE REPRODUCED WITHOUT WRITTEN CONSENT ©**

Dig Sites:  
 Area  Line   
 Approx scale on A4 paper: 1:1000  
 (excluding Overview map)



Date Requested: 24/03/2015  
 Requested by: Stephen Sawyer  
 Job Reference: 6601423



Company: Technics Group  
 Your Scheme/Reference: EMS00347

Key for Mains & Service Pipework	
	Existing LP mains or services operating up to 75 millibar gauge
	Existing MP mains or services operating between 75 millibar and 2 bar gauge
	Existing IP mains or services operating between 2 bar and 7 bar gauge



Whilst ESP Utilities Group Ltd (ESP) try to ensure the asset information we provide is accurate, the information is provided Without Prejudice and ESP accept no liability for claims arising from any inaccuracy, omissions or errors contained in this response. The actual position of underground services must be verified and established on site before any mechanical plant is used. Authorities and contractors will be held liable for the full cost of repairs to ESP apparatus and all claims made against them by Third parties as a result of any interference or damage.

**REPRODUCED FROM THE ORDNANCE SURVEY MAP WITH THE SANCTION OF THE CONTROLLER OF HER MAJESTY'S STATIONARY OFFICE © CROWN COPYRIGHT RESERVED.**  
**THIS DRAWING IS THE COPYRIGHT OF ES PIPELINES LIMITED AND MAY NOT BE REPRODUCED WITHOUT WRITTEN CONSENT ©**

Dig Sites:  
 Area  Line   
 Approx scale on A4 paper: 1:1000  
 (excluding Overview map)

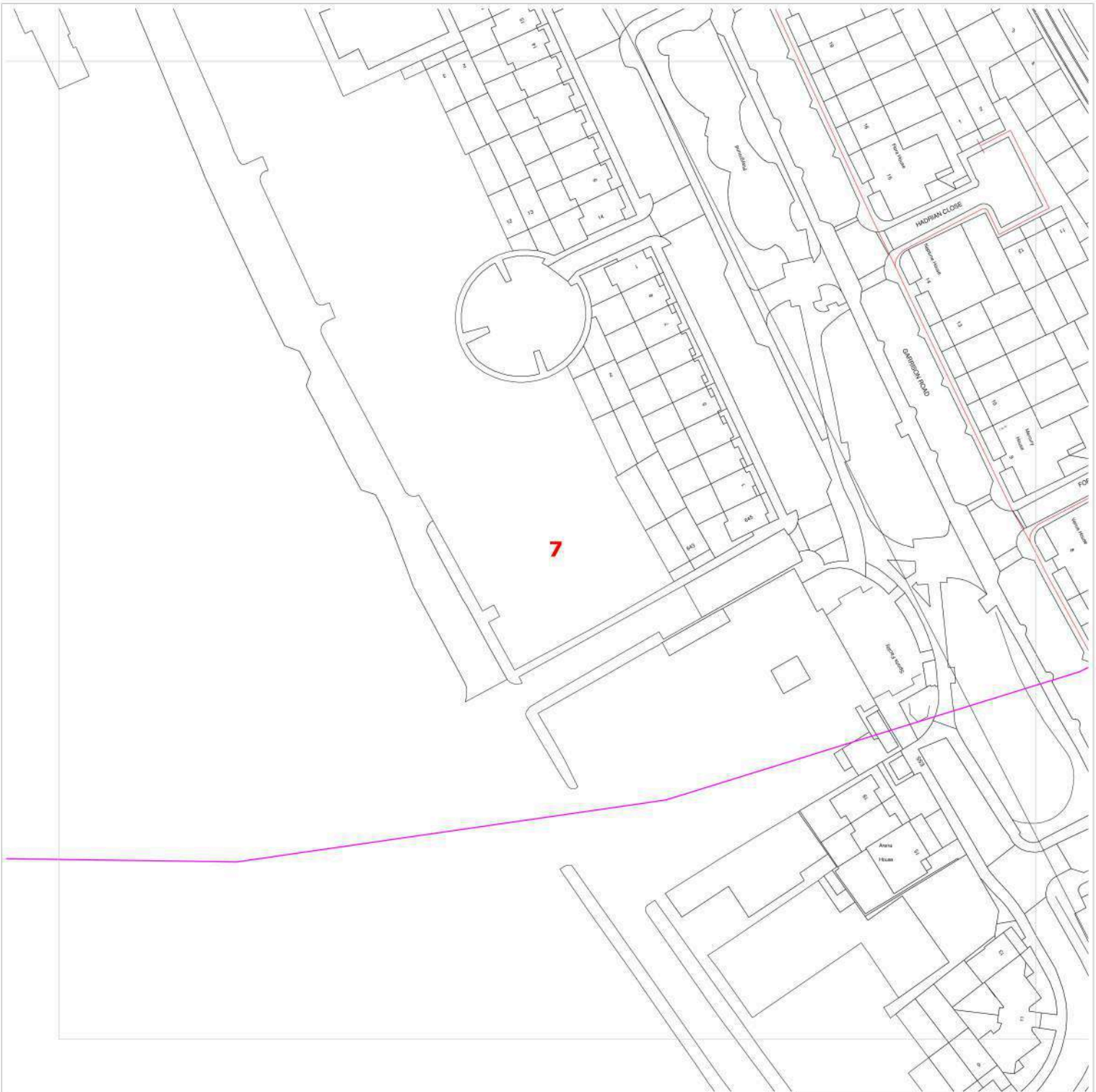

Date Requested: 24/03/2015  
 Requested by: Stephen Sawyer  
 Job Reference: 6601423

Company: Technics Group  
 Your Scheme/Reference: EMS00347

**Key for Mains & Service Pipework**



Existing LP mains or services operating up to 75 millibar gauge



Existing MP mains or services operating between 75 millibar and 2 bar gauge



Existing IP mains or services operating between 2 bar and 7 bar gauge



Whilst ESP Utilities Group Ltd (ESP) try to ensure the asset information we provide is accurate, the information is provided Without Prejudice and ESP accept no liability for claims arising from any inaccuracy, omissions or errors contained in this response. The actual position of underground services must be verified and established on site before any mechanical plant is used. Authorities and contractors will be held liable for the full cost of repairs to ESP apparatus and all claims made against them by Third parties as a result of any interference or damage.

**REPRODUCED FROM THE ORDNANCE SURVEY MAP WITH THE SANCTION OF THE CONTROLLER OF HER MAJESTY'S STATIONARY OFFICE © CROWN COPYRIGHT RESERVED.  
 THIS DRAWING IS THE COPYRIGHT OF ES PIPELINES LIMITED AND MAY NOT BE REPRODUCED WITHOUT WRITTEN CONSENT ©**

Dig Sites:  
 Area Line   
 Approx scale on A4 paper: 1:1000  
 (excluding Overview map)

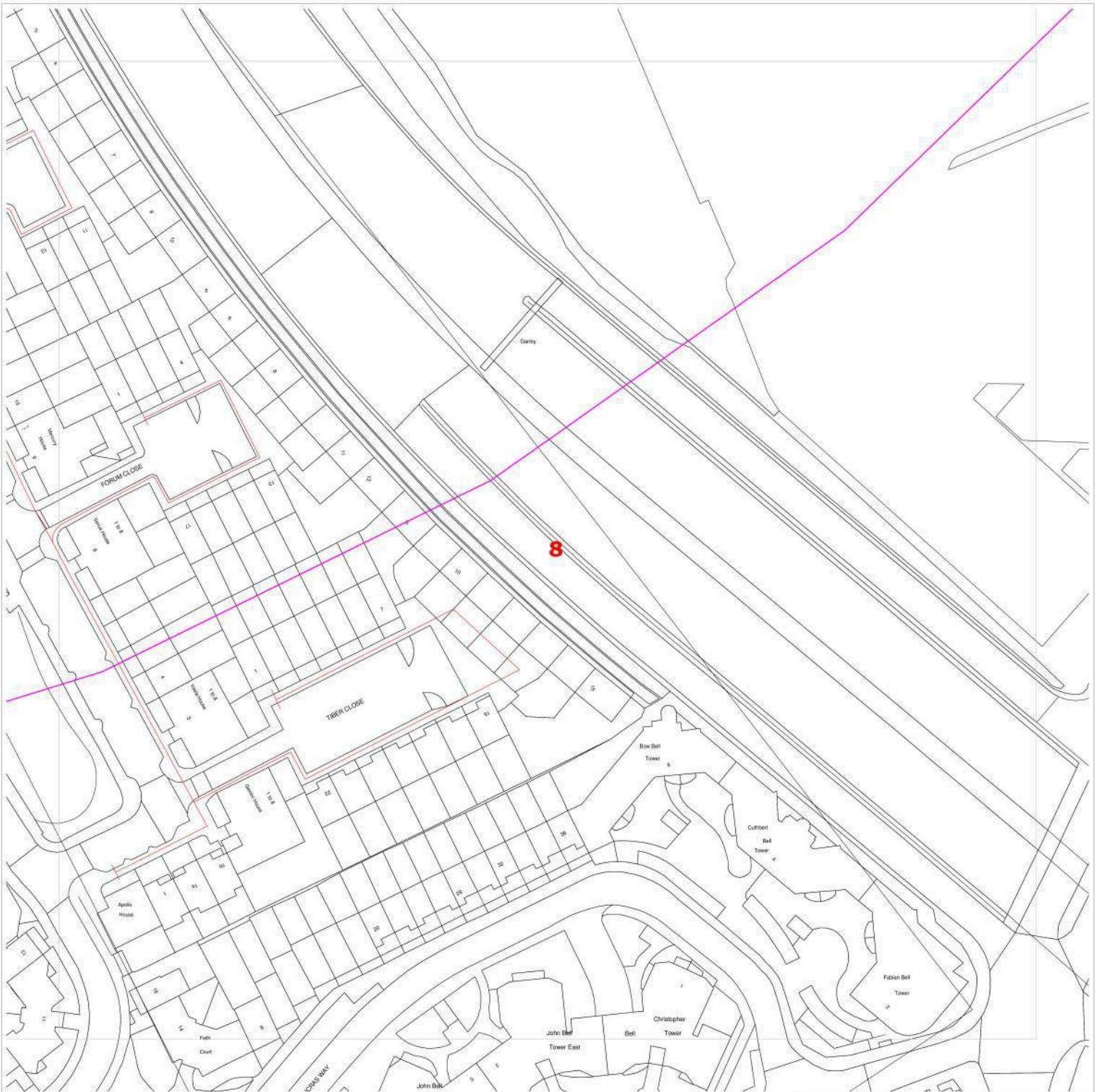

Date Requested: 24/03/2015  
 Requested by: Stephen Sawyer  
 Job Reference: 6601423

Company: Technics Group  
 Your Scheme/Reference: EMS00347

**Key for Mains & Service Pipework**



Existing LP mains or services operating up to 75 millibar gauge



Existing MP mains or services operating between 75 millibar and 2 bar gauge





Existing IP mains or services operating between 2 bar and 7 bar gauge



Whilst ESP Utilities Group Ltd (ESP) try to ensure the asset information we provide is accurate, the information is provided Without Prejudice and ESP accept no liability for claims arising from any inaccuracy, omissions or errors contained in this response. The actual position of underground services must be verified and established on site before any mechanical plant is used. Authorities and contractors will be held liable for the full cost of repairs to ESP apparatus and all claims made against them by Third parties as a result of any interference or damage.

**REPRODUCED FROM THE ORDNANCE SURVEY MAP WITH THE SANCTION OF THE CONTROLLER OF HER MAJESTY'S STATIONARY OFFICE © CROWN COPYRIGHT RESERVED.**  
**THIS DRAWING IS THE COPYRIGHT OF ES PIPELINES LIMITED AND MAY NOT BE REPRODUCED WITHOUT WRITTEN CONSENT ©**

Dig Sites:  
 Area  Line   
 Approx scale on A4 paper: 1:1000  
 (excluding Overview map)

---

**PRECAUTIONS TO BE TAKEN WHEN CARRYING OUT WORK IN THE VICINITY OF UNDERGROUND GAS PIPES**

**ADVICE TO SITE PERSONNEL**

**MANAGEMENT NOTE**

Please ensure that a copy of this note is read by your site management and to your site operatives.

Early consultation with ESP Utilities Group prior to excavation is recommended to obtain the location of plant and precautions to be taken when working nearby.

This Guidance Note should be read in conjunction with the Health and Safety Executive guidance HSG47 "Avoiding danger from underground services".

---

**Introduction**

Damage to ESP Utilities Group's plant can result in uncontrolled gas escapes which may be dangerous. In addition these occurrences can cause expense, disruption of work and inconvenience to the public.

Various materials are used for gas mains and services. Cast Iron, Ductile Iron, Steel and Plastic pipes are the most widely found. Modern Plastic pipes are either bright yellow or orange in colour.

Cast Iron and Ductile Iron water pipes are very similar in appearance to Cast Iron and Ductile Iron gas pipes and if any Cast Iron or Ductile Iron pipe is uncovered, it should be treated as a gas pipe. ESP Utilities Group do not own any metallic gas pipes but their gas network infrastructures may be connected to Cast Iron, Ductile Iron or Steel pipes owned by Transco.

The following general precautions apply to Intermediate Pressure (2-7barg MOP), Medium Pressure (75mbarg-2barg MOP), Low Pressure (up to 75mbarg MOP) and other gas mains and services likely to be encountered in general site works and are referred to within this document as 'pipes'.

**Locating Gas Pipes**

It should be assumed when working in urban and residential areas that gas mains and services are likely to be present. On request, ESP Utilities Group will give approximate locations of pipes derived from their records. The records do not normally show the position of service pipes but their probable line can be deducted from the gas meter position. ESP Utilities Group's staff will be pleased to assist in the location of gas plant and provide advice on any precautions that may be required. The records and advice are given in good faith but cannot be guaranteed until hand excavation has taken place. Proprietary pipe and cable locators are available although generally these will not locate plastic pipes.

**Safe working Practices**

**To achieve safe working conditions adjacent to gas plant the following must be observed:**

Observe any specific request made by ESP Utilities Group's staff.

Gas pipes must be located by hand digging before mechanical excavation. Once a gas pipe has been located, mechanical excavation must proceed **with care**. A mechanical excavator must not in any case be used within 0.5 metre of a gas pipe and greater safety distances may be advised by ESP Utilities Group depending on the mains maximum operating pressure (MOP).

Where heavy plant may have to cross the line of a gas pipe during construction work, the number of crossing points should be kept to a minimum. Crossing points should be clearly indicated and crossings at other places along the line of the pipe should be prevented.

Where the pipe is not adequately protected by an existing road, crossing points should be suitably reinforced with sleepers, steel plates or a specially constructed reinforced concrete raft as necessary. ESP Utilities Group staff will advise on the type of reinforcement necessary.

No explosives should be used within 30 metres of any gas pipe without prior consultation with ESP Utilities Group.

**ESP Utilities Group must be consulted prior to carrying out excavation work within 10 metres of any above ground gas installation.**

Where it is proposed to carry out piling or boring within 15 metres of any gas pipe, ESP Utilities Group should be consulted prior to the commencement of the works.

Access to gas plant must be maintained at all times during on site works.



---

### **Proximity of Other Plant**

A minimum clearance of 300 millimetres (mm) should be allowed between any plant being installed and an existing gas main to facilitate repair, whether the adjacent plant be parallel to or crossing the gas pipe. No apparatus should be laid over and along the line of a gas pipe irrespective of clearance.

No manhole or chambers shall be built over or around a gas pipe and no work should be carried out which results in a reduction of cover or protection over a pipe, without consultation with ESP Utilities Group.

### **Support and Backfill**

Where excavation of trenches adjacent to any pipe affects its support, the pipe must be supported to the satisfaction of ESP Utilities Group and must not be used as an anchor or support in any way. In some cases, it may be necessary to divert the gas pipe before work commences.

Where a trench is excavated crossing or parallel to the line of the gas pipe, the backfill should be adequately compacted, particularly beneath the pipe, to prevent any settlement which could subsequently cause damage to the pipe.

In special cases it may be necessary to provide permanent support to the gas pipe, before backfilling and reinstatement is carried out. Backfill material adjacent to gas plant must be selected fine material or sand, containing no stones, bricks or lumps of concrete, etc., placed to a minimum depth of 150mm around the pipes and well compacted by hand. No power compaction should take place until 300 mm of selected fine fill has been suitably compacted.

If the road construction is in close proximity to the top of the gas pipe, a "cushion" of selected fine material such as sand must be used to prevent the traffic shock being transmitted to the gas pipe. The road construction depth must not be reduced without permission from the local Highway Authority.

No concrete or other hard material must be placed or left under or adjacent to any Cast Iron pipe as this may cause fracture of the pipe at a later date.

Concrete backfill should not be used closer than 300 mm to the pipe.

### **Damage to Coating**

Where a gas pipe is coated with special wrapping and this is damaged, even to a minor extent ESP Utilities Group must be notified so that repairs can be made to prevent future corrosion and subsequent leakage.

### **Welding or "Hot Works"**

When welding or other "hot works" involving naked flames are to be carried out in close proximity to gas plant and the presence of gas is suspected, ESP Utilities Group must be contacted before work commences to check the atmosphere. Even when a gas free atmosphere exists care must be taken when carrying out hot works in close proximity to gas plant in order to ensure that no damage occurs.

Particular care must be taken to avoid damage by heat or naked flame to plastic gas pipes or to the protective coating on other gas pipes.

### **Leakage from Gas Mains or Services**

If damage or leakage is caused or an escape of gas is smelt or suspected the following action should be taken at once:

- ❖ Remove all personnel from the immediate vicinity of the escape;
- ❖ Contact Transco's National Gas Escape Call Centre, on: **0800 111 999**;
- ❖ Prevent any approach by the public, prohibit smoking, extinguish all naked flames or other source of ignition for at least 15 metres from the leakage;
- ❖ Assist gas personnel, Police or Fire Service as requested.

## Utility Reports

---

**From:**

**Sent:**

**To:**

**Subject:**

**Attachments:**

### **Warning: GTC Apparatus Exists in This Area**

**Our Plant Enquiry Service Ref: 97606**

**Your Enquiry Ref: EMS00347**

Dear Utility,

Thank you for your enquiry concerning apparatus in the vicinity of your proposed work. For your records, the search area is shown in the attached map.

Please click on the links below to download copies of the relevant utility asset drawings locating our assets in the area which you identified. These drawings are grouped by our relevant network reference, should you need to contact us regarding any of our networks please quote this reference. Links to files will remain live for 10 days. If you do not download these files within this period you will need to submit a new enquiry – this will ensure you have an up-to-date copy of our asset records.

**PLEASE NOTE:** Where drawings are large, these have been provided in smaller segments. A drawing index is provided as the first file listed for each network reference (example of a network reference: N1234567) shown below. This is intended to help you find the drawing relevant to you more quickly. Please take care to ensure that you use the relevant drawings for every network listed below as we may have multiple networks and multiple utilities in this area.

#### **N0003185-1**

##### **Gas**

- [N0003185-1.png](#)

This information is for guidance only and the precise position of the plant must be established, prior to your works, using hand-digging methods only. The contractor will be held responsible for any damage caused to our asset. Please note our assets now include those owned and operated by:

- GTC Pipelines Limited
- Independent Pipelines Limited
- Quadrant Pipelines Limited
- Electricity Network Company Limited
- Independent Power Networks Limited
- Independent Water Networks Limited
- Independent Fibre Networks Limited
- Independent Community Heating Limited

If you have any queries or require any further information please do not hesitate to contact us.

All works in the vicinity of our networks should be undertaken in accordance with the attached document "GU-DPR-IG-0022: Safe working in the vicinity of utility networks". Reference should also be made to HSG47 Avoiding Danger from Underground Services.

**Important: The area of your proposed works may contain gas mains operating at Medium and Intermediate Pressure tiers or electric cables operating at High Voltage – please refer to the network drawings included with this email. If your proposed works are likely to involve excavation within 10 metres of any of these assets, including but not limited to gas governors and electric substations you MUST inform GTC Plant Enquiries by calling 01359 240363 and quoting your Plant Enquiries Service Reference number.**

**Important: Drawings provided by this service may include utility assets not owned or managed by GTC. Conversely our drawings will NOT display assets from all third parties. It is your responsibility to ensure you have requested information from all utility asset owners.**

**Gas Escape or Damage MUST be reported on 0800 111 999. National Grid / DNGT will attend to make safe and repair.**

**Electricity Network Damage MUST be reported to ENC on 0800 032 6990.**

**Water Network Damage MUST be reported to IWNL on 02920 028 711**

**Fibre Network Damage MUST be reported to IFNL on 0845 051 1669**

**Thank you for using the GTC Plant Enquiries Service.**

Your sincerely,

GTC Plant Enquiry Service



## GU-DPR-IG-0022

### SAFE WORKING IN THE VICINITY OF UTILITY NETWORKS

(Refer to the HSE Guidance Document HSG47)

#### General

1. It is imperative that all works are carried out in accordance with the guidance provided by the HSE in their document HSG47 "Avoiding Danger from Underground Services", ISBN 0-7176-1744-0. No party should carry out any excavation works or other intrusive works such as piling, blasting or demolition without following the guidance in HSG47.
2. We own gas, electricity, water and fibre apparatus located in the highway, private property and through the countryside. Some plant may be located in land for which a wayleave or easement has been granted & there may be no surface evidence of the presence of apparatus.
3. Ensure that you have obtained detailed plans of existing and proposed gas, electricity water and fibre networks.
4. The position of the networks should be pinpointed as accurately as possible by reference to the plans and by means of a locating device, which has been tested and calibrated within the last twelve months.

Excavation work should be carried out where applicable, and carefully follow recognised safe digging practices. Once a locating device has been used to determine position and route, excavation may proceed; trial holes should be dug using suitable hand tools to confirm the position of buried networks. During excavation the locating device should be reused to check position and route of buried apparatus.

5. Hand-held power tools can damage buried apparatus and should be used with care until the exact position has been determined. They may only be used to break a paved or concrete surface above the network, unless there are any indications that the network is particularly shallow, in such circumstances, accuracy of plant location is determined and excavation initiated adjacent to the apparatus.
6. No manhole, chamber or other structure should be built over, around or under the network. Such structures, other pipes, ducts and cables should be laid to provide a minimum clearance from the network of 300mm or 1.5 times the diameter of the network, whichever is the greater. No work should be carried out if this minimum clearance cannot be met or which results in a reduction of cover or protection over the network, without first consulting GTC.
7. Where an excavation uncovers a network apparatus the backfill should be adequately compacted, particularly beneath the network, to prevent any settlement, which would subsequently damage the network. Backfill material adjacent to the network should be selected fine material or sand, containing no stones, bricks or lumps of concrete etc. and should be suitably compacted to give comparable support and protection to that provided before excavation. No power compaction should take place until 200mm cover of selected fine fill has been suitably compacted by hand tools.

8. If the road construction is close to the top of the network, GTC should be asked about necessary precautions. The road construction depth should not be reduced without permission from the local Highway Authority.
9. Costs incurred by GTC through direct or consequential damage will be recharged.

### **Precautions for Gas Networks**

10. Plans do not always show the presence of gas pipes cables (from the gas main to premises) but their existence should be assumed.
11. The depth of cover for gas mains is normally 750mm in carriageways and grass verges and 600mm in footways. The depth of cover for gas services is normally 450mm. Remember these covers are to finished level, you may be working in an area, which will be made up or lowered at a later date.
12. Plastic gas pipes should be located by hand digging before mechanical excavation begins. When the positions and depth of the pipes have been determined, work can proceed.
13. The danger created by damaging a gas pipe with an excavator is much greater than if the damage is done with a hand-held power tool (the opposite is true for work near electricity cables and this is reflected in the different safe digging practices). Gas pipes may have projections such as valve housings, which are not shown on the plans and to allow for this mechanical excavators should not be used within 500mm of a gas pipe.
14. If a gas leak is suspected, the following action should be taken immediately:
  - Remove all people from the immediate vicinity of the escape. If the service connection to a building or the adjacent main has been damaged, warn the occupants to leave the building, and any adjoining building, until it is safe for them to return. It is important to note that a mechanical excavator may not only cause damage/leakage at the point of impact. For example, damage to a service connection outside the building may result in further, unseen damage to the connection inside the building. Gas leaking from the damage inside or gas travelling along the line of the service connection pipe from outside the building may cause a build-up of gas within the building.
  - Prohibit smoking, and extinguish all naked flames and other sources of ignition i.e. stop excavator and compressor engines within at least 5.0m of the leak.
  - Inform National Grid by dialling **0800 111 999**
  - Remain on site.
  - Assist National Grid staff, Police or Fire Services as requested.
15. Where gas pipes cross or are parallel and close to excavations, changes in backfill etc. may cause differential ground settlement and increased stress in the pipe. For pipes parallel and close to excavations, the degree of risk depends upon the depth of the excavation, the distance of the pipe from the excavation, the type of soil and any excessive loading from heavy construction plant and materials. Wherever excavation works may affect the support of the gas pipe or cause excessive loading over the gas pipe then GTC must be consulted.

16. No concrete or other hard material should be placed or left under or adjacent to any gas pipe as this can cause pipe fracture at a later date. Concrete backfill should not be used within 300mm of a gas pipe.
17. Where an excavation uncovers a gas pipe with a damaged wrapping, GTC should be told, so that repairs can be made to prevent future corrosions and leakage.
18. Pipe restraints or thrust blocks close to gas mains should never be removed.
19. Anyone who carries out work near underground gas plant should observe any specific requirements made by the site manager, and ensure that access to the plant by National Grid Gas and GTC staff is available at all times. No unauthorised repairs to gas pipes should be made.
20. Where excavation is within 5 metres proximity to above or below ground pressure control equipment, ground workers must be aware of the possibility of encountering small impulse pipe work that is more susceptible to damage.
21. Where PE pipes and cables have been exposed and it is intended hot work (e.g. welding, grinding, etc) be carried out, contact must be made with GTC to confirm additional precautions and actions that may require to be undertaken.
22. GTC should be consulted if it is intended to carry out any of the following activities:
  - using explosives within 30m of gas pipes or 400m of gas pressure reduction equipment
  - piling or boring within 15m of gas plant
  - excavating within 10m of pressure reduction equipment
  - reducing the cover or protection of a gas pipe
  - carrying out nearby deep excavations
  - working near our intermediate pressure (IP) mains.

### **Precautions for Electricity Networks**

23. Plans do not always show the presence of electric service cables (from the electricity main to premises) but their existence should be assumed.
24. In most cases there will be no permanent surface marker posts or other visible indication of the presence of a buried cable. Even if no cables are shown on plans or detected by a locator, there may still be cables present, which could be live and a close watch should be kept for any signs which could indicate their presence such as marker tape, tape tile, concrete tiles and wooden battens. Any marker which is disturbed by our excavations must be replaced once work is completed.
25. Typically underground cables are laid in trenches between 450mm and 1.0m deep, although some high voltage cables will be deeper, however, depths should never be assumed.
26. A cable is positively located only when it has been safely exposed. Even then, digging should still proceed with care as there may be other cables adjacent or lower down.

27. Occasionally, cables are terminated in the ground by means of a seal, sometimes with external mechanical protection. These “pot ended” or “bottle ended” cables should be treated as live and should not be assumed to be abandoned or disused. They can be difficult to detect with locators even when “live”.
28. Using hand held power tools to break up hard surfaces often leads to accidents. Where practicable, such power tools should only be used 500mm or more away from the indicated line of a cable buried in or below a hard surface. Having done so, the cable should then be positively located by careful hand digging under the hard surface. The hard surface should be gradually removed until the cable is exposed. If the cable is not exposed then it must be assumed to be embedded within the surface. Where possible a cable locator should be used as a depth guide down the side of the excavation.
29. Because of the difficulty in confirming depth, hand held power tools should never be used over the cable unless either:
  - the cable has already been exposed by digging under the surface to be broken out and it is at a safe depth (at least 300mm) below the bottom of the hard surface material; or
  - physical precautions have been taken to prevent the tool striking the cable.
30. Excavating close to electricity cables buried in concrete is dangerous and should not be undertaken unless the cable(s) have been isolated. For this reason alone electricity cables should not be buried in concrete.
31. Using mechanical means to break up concrete can cause damage to cables and if the cable is live, anyone present is likely to be injured.
32. Where mechanical excavators are used in the possible vicinity of underground cables, the work should be arranged so that damage to cables is avoided so far as is reasonably practicable and so that everyone is kept well clear of the excavator bucket while it is digging. Drivers should have been instructed to stay in the cab if a cable is struck. If they have to leave the cab, they should jump clear. If drivers climb down, they may be electrocuted. When a cable is struck, a watch should be kept on the machine and no one should go down into the excavation or approach the mechanical excavator or the cable until GTC are contacted and arranged for the damaged cable to be made safe.
33. Where cables have been exposed:
  - any damage should be reported to GTC immediately on **0800 032 6990** and work should not be undertaken in the vicinity of a damaged cable until GTC has investigated its condition;
  - for more than 1.0m and they cross a trench, support should be provided. If the exposed cable length is shorter than 1.0m support should still be considered if joints have been exposed or the cable appears otherwise vulnerable to damage. Where advice and help is needed contact GTC;



- Suitable precautions should be taken to prevent damage from on-going work in the excavation. This may involve for example the use of physical means (e.g. timber boards, sandbags etc) to prevent mechanical damage. Materials or equipment which could damage or penetrate the outer sheath of the cable should not be used. Cables lying in the bottom of an excavation are particularly vulnerable and should be protected by nail free wooden planks, troughing or other suitable means;
  - cables should not be moved aside unless the operation is supervised by GTC;
  - Precautions should be taken to prevent access by members of the public.
34. GTC should be consulted if it is intended to carry out any of the following activities:
- using explosives within 30m of plant or substations piling or boring within 15m of electric plant
  - excavating within 10m of a substation
  - carrying out nearby deep excavations
  - working near our HV plant.

### **Precautions for Water Networks**

35. Plans do not always show the presence of water service cables (from the water main to premises) but their existence should be assumed.
36. The depth of cover for water mains is normally 750mm in carriageways and grass verges and 750mm footways. The depth of cover for water services is normally 450mm. Remember these covers are to finished level, you may be working in an area, which will be made up or lowered at a later date.
37. Water mains should be located by hand digging before mechanical excavation begins. When the positions and depth of the pipes have been determined, work can proceed.
38. The danger created by damaging a water pipe with an excavator is much greater than if the damage is done with a hand-held power tool (the opposite is true for work near electricity cables and this is reflected in the different safe digging practices). Water pipes may have projections such as valve housings, which are not shown on the plans and to allow for this mechanical excavators should not be used within 500mm of a water pipe.
39. If a water leak is suspected, the following action should be taken immediately:
- Remove all people from the immediate vicinity of the damage. It is important to note that a mechanical excavator may not only cause damage/leakage at the point of impact. For example, damage to a service connection outside the building may result in further, unseen damage to the connection inside the building.
  - Shut down all working plant and machinery in the vicinity of the damage
  - Inform IWNL by dialling **02920 028 711**.
  - Remain on site.

- Do not attempt to make a repair.
  - Assist GTC, approved contractors and Police or Fire Services as requested.
40. Where water pipes cross or are parallel and close to excavations, changes in backfill etc. may cause differential ground settlement and increased stress in the pipe. For pipes parallel and close to excavations, the degree of risk depends upon the depth of the excavation, the distance of the pipe from the excavation, the type of soil and any excessive loading from heavy construction plant and materials. Wherever excavation works may affect the support of the water pipe or cause excessive loading over the water pipe then GTC must be consulted.
  41. No concrete or other hard material should be placed or left under or adjacent to any water pipe as this can cause pipe fracture at a later date. Concrete backfill should not be used within 300mm of a water pipe.
  42. Where an excavation uncovers a water pipe with a damaged wrapping, GTC should be told, so that repairs can be made to prevent future corrosions and leakage.
  43. Pipe restraints or thrust blocks close to water mains should never be removed.
  44. Anyone who carries out work near underground water plant should observe any specific requirements made by the site manager, and ensure that access to the plant by GTC staff is available at all times. No unauthorised repairs to water pipes should be made.
  45. Where PE pipes and cables have been exposed and it is intended hot work (e.g. welding, grinding, etc) be carried out, contact must be made with GTC to confirm additional precautions and actions that may require to be undertaken.
  46. GTC should be consulted if it is intended to carry out any of the following activities:
    - using explosives within 30m of plant
    - piling or boring within 15m of water plant
    - excavating within 10m of water asset structures
    - reducing the cover or protection of a water main or service
    - carrying out nearby deep excavations

### **Precautions for Fibre Networks**

47. Plans may not always show the presence of fibre ducts but their existence should be assumed if GTC advise they have fibre services deployed in the given area. Any planned excavation work should only proceed with due care and attention.
48. Chambers with IFNL marked lids can be used as an onsite indicator that GTC have fibre plant deployed in a given area however an exclusion of their presence does not necessarily mean there is no plant present.
49. In most cases there will be no permanent surface marker posts or other visible indication of the presence of a buried fibre duct. Even if no ducts are shown on plans there may still be ducts present which could have live fibre service installed. A close watch should be kept for any signs which could indicate duct presence such as marker tape. Any marker which is disturbed by our excavations must be replaced once work is completed.

50. The depth of cover for fibre duct is normally 350mm in footways and grass verges, 600mm in carriageways and 1000mm in agricultural deployments. Remember these covers are to finished level, you may be working in an area, which will be made up or lowered at a later date.
51. Fibre ducts should be located by hand digging before mechanical excavation begins. When the positions and depth of the ducts have been determined, work can proceed. Even then, digging should still proceed with care as there may be other ducts adjacent or lower down.
52. If fibre duct damage is suspected, the following action should be taken immediately:
  - Remove all people from the immediate vicinity of the damage. It is important to note that a mechanical excavator may not only cause damage at the point of impact. For example, damage to a fibre connection outside the building may result in further, unseen damage to the connection inside the building.
  - Shut down all working plant and machinery in the vicinity of the damage
  - Inform IFNL NOC immediately on **0845 051 1669**.
  - Remain on site.
  - Do not attempt to make a repair.
53. Where fibre ducts cross or are parallel and close to excavations, changes in backfill etc. may cause differential ground settlement and increased stress on the duct. For ducts parallel and close to excavations, the degree of risk depends upon the depth of the excavation, the distance of the duct from the excavation, the type of soil and any excessive loading from heavy construction plant and materials. Wherever excavation works may affect the support of the fibre duct or cause excessive loading over the fibre duct then GTC must be consulted.
54. No concrete or other hard material should be placed or left under or adjacent to any fibre duct as this can cause damage to the duct at a later date. Any backfill should comply with the requirements of NRSWA. Concrete backfill should not be used within 300mm of a fibre duct.
55. Anyone who carries out work near underground fibre plant should observe any specific requirements made by the site manager, and ensure that access to the plant by GTC staff is available at all times. No unauthorised repairs to fibre ducts should be made.
56. Where fibre ducts have been exposed and it is intended hot work (e.g. welding, grinding, etc) be carried out, contact must be made with GTC to confirm additional precautions and actions that may require to be undertaken.
57. GTC should be consulted if it is intended to carry out any of the following activities:
  - using explosives within 30m of plant or fibre asset structures
  - piling or boring within 15m of fibre plant
  - excavating within 10m of fibre asset structures (including the OSCP)
  - reducing the cover or protection of a fibre duct
  - carrying out nearby deep excavations

**Telecoms/Cable**



Mr Stephen Sawyer  
Technics Group  
Technics House Merrow Business Park  
Guildford Surrey  
GU4 7WA

Date: 24/03/2015

Our Reference: 6601423  
Your Reference: EMS00347

Dear Mr Stephen Sawyer,

#### **ZAYO GROUP UK LTD AFFECTED C2 PRELIMINARY PLANT ENQUIRY**

We acknowledge with thanks your request dated 24/03/2015 09:19:29 AM for information on the location of our services.

Please find enclosed plan(s) showing the approximate position of our apparatus known to be in the vicinity of this site.

We confirm we have reviewed your proposed plan, and have enclosed maps of the area in which Zayo Group UK Ltd have apparatus.

Please note these maps indicate approximate location only and their accuracy cannot be guaranteed. To determine the exact location a trial hole must be dug using extreme caution and hand dig methods only. Please refer to the attached document "Guide to Excavation within the vicinity of Zayo Apparatus".

If you would like a Supervisor on site to mark the trench, or to supervise works around the apparatus, please call 5 days in advance to schedule a site meeting. Please note this maybe chargeable.

Please forward all C3 and C4 Diversionary Estimate requests for diversionary works under the New Roads and Street Works Act 1991 "Measures necessary where apparatus is affected by Major Works (Diversionary Works), A Code of Practice", to

Please do not hesitate to contact us for further assistance.

Regards,

---







Date Requested: 24/03/2015

Requested by: Stephen Sawyer

Company: Technics Group

Job Reference: 6601423

Your Scheme/Reference: EMS00347

 ZAYO DUCT  
 or  ZAYO CHAMBER  
 Dig Sites: Line  Area   
 Scale on A4 paper: 1:1000



The information on this document is proprietary and shall not be used, copied, reproduced or disclosed in whole or in part without written consent of Zayo Group UK Ltd. Approximate location only is shown. To determine exact location a trial hole must be dug with a Zayo Group UK Ltd Supervisor present. Zayo Group UK Ltd and JSM Construction Ltd accept no liability for errors or omissions.



Protecting Lives, Cables & Pipes

Warning: PDF designed for colour print only with no page scaling. This Information is given as a guide only and its accuracy cannot be guaranteed



In Emergency Only and if Zayo Plant or Cables damaged call: 0800 169 1646

CROWN COPYRIGHT © All Rights Reserved. Ordnance Survey Licence number: 100040487

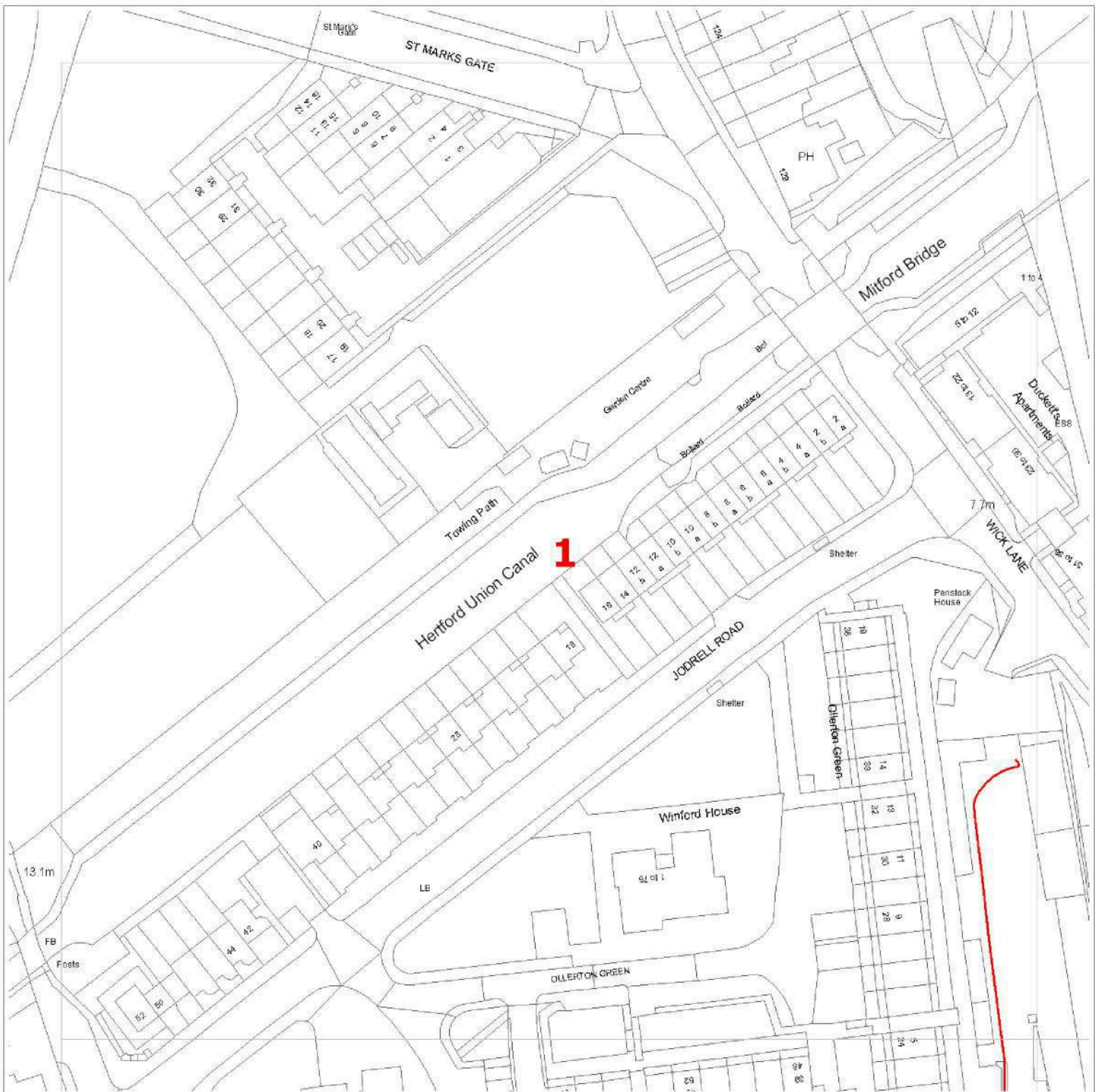





Date Requested: 24/03/2015

Requested by: Stephen Sawyer

Company: Technics Group

Job Reference: 6601423

Your Scheme/Reference: EMS00347

 ZAYO DUCT  
 or  ZAYO CHAMBER  
 Dig Sites: Line  Area   
 Scale on A4 paper: 1:1000



The information on this document is proprietary and shall not be used, copied, reproduced or disclosed in whole or in part without written consent of Zayo Group UK Ltd. Approximate location only is shown. To determine exact location a trial hole must be dug with a Zayo Group UK Ltd Supervisor present. Zayo Group UK Ltd and JSM Construction Ltd accept no liability for errors or omissions.



Protecting Lives, Cables & Pipes

Warning: PDF designed for colour print only with no page scaling. This Information is given as a guide only and its accuracy cannot be guaranteed



In Emergency Only and if Zayo Plant or Cables damaged call: 0800 169 1646

CROWN COPYRIGHT © All Rights Reserved. Ordnance Survey Licence number: 100040487

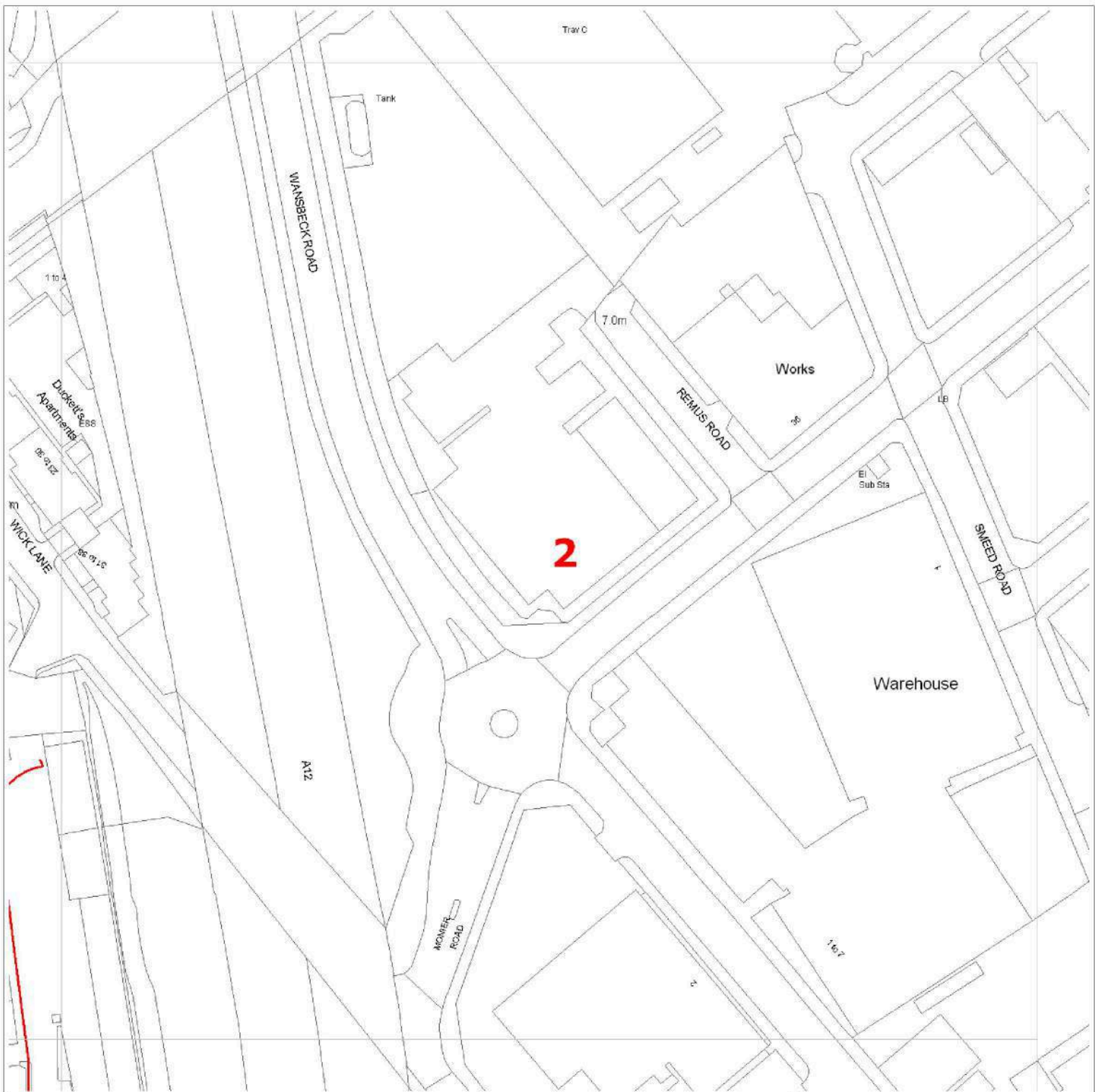

Date Requested: 24/03/2015

Requested by: Stephen Sawyer

Company: Technics Group

Job Reference: 6601423

Your Scheme/Reference: EMS00347

 ZAYO DUCT

 or  ZAYO CHAMBER

Dig Sites: Line  Area 

Scale on A4 paper: 1:1000



The information on this document is proprietary and shall not be used, copied, reproduced or disclosed in whole or in part without written consent of Zayo Group UK Ltd. Approximate location only is shown. To determine exact location a trial hole must be dug with a Zayo Group UK Ltd Supervisor present. Zayo Group UK Ltd and JSM Construction Ltd accept no liability for errors or omissions.



Protecting Lives, Cables & Pipes

Warning: PDF designed for colour print only with no page scaling. This Information is given as a guide only and its accuracy cannot be guaranteed



In Emergency Only and if Zayo Plant or Cables damaged call: 0800 169 1646

CROWN COPYRIGHT © All Rights Reserved. Ordnance Survey Licence number: 100040487



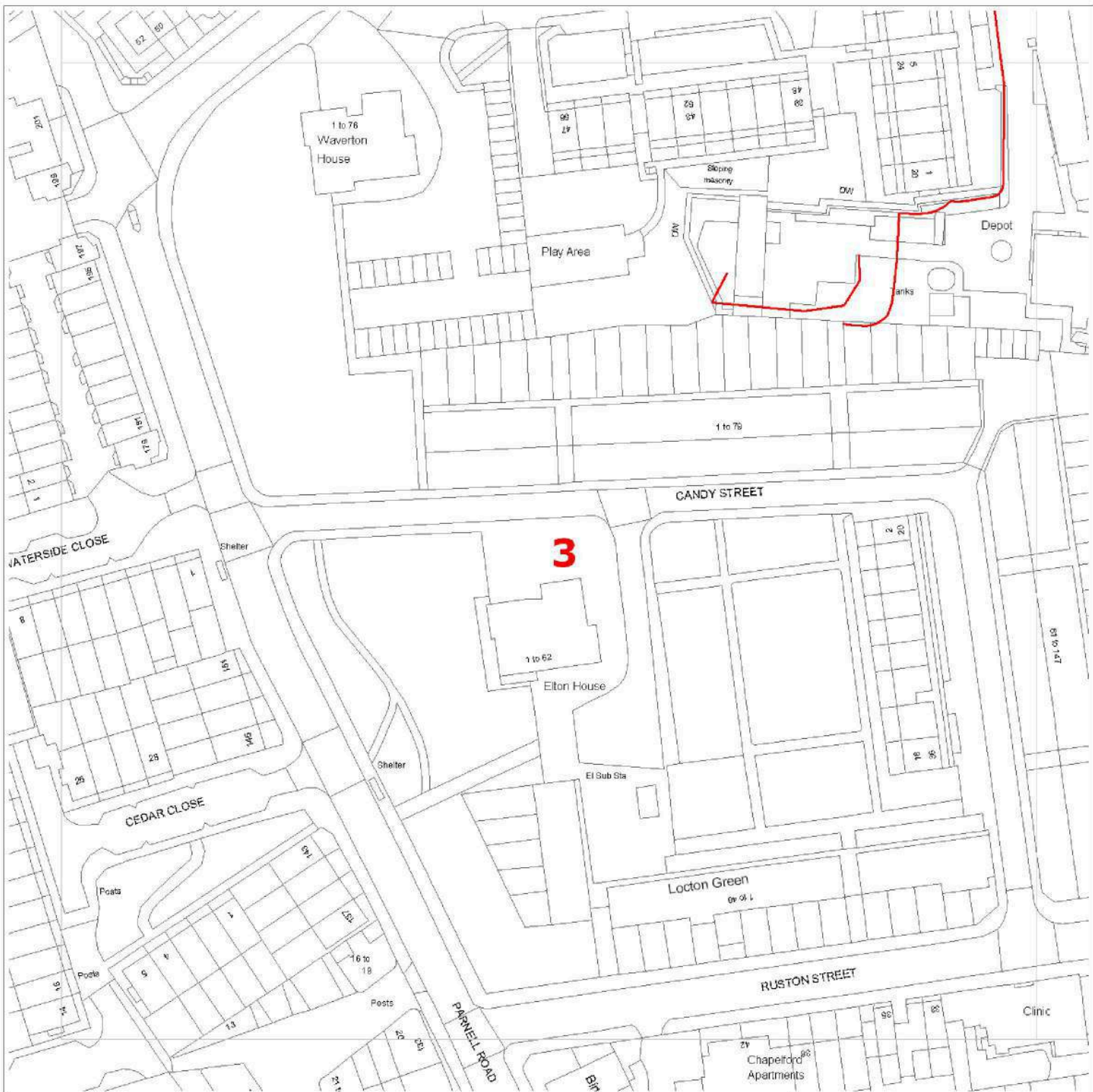





Date Requested: 24/03/2015

Requested by: Stephen Sawyer

Company: Technics Group

Job Reference: 6601423

Your Scheme/Reference: EMS00347

 ZAYO DUCT  
 or  ZAYO CHAMBER  
 Dig Sites: Line  Area   
 Scale on A4 paper: 1:1000



The information on this document is proprietary and shall not be used, copied, reproduced or disclosed in whole or in part without written consent of Zayo Group UK Ltd. Approximate location only is shown. To determine exact location a trial hole must be dug with a Zayo Group UK Ltd Supervisor present. Zayo Group UK Ltd and JSM Construction Ltd accept no liability for errors or omissions.



Warning: PDF designed for colour print only with no page scaling. This Information is given as a guide only and its accuracy cannot be guaranteed



Protecting Lives, Cables & Pipes

In Emergency Only and if Zayo Plant or Cables damaged call: 0800 169 1646

CROWN COPYRIGHT © All Rights Reserved. Ordnance Survey Licence number: 100040487

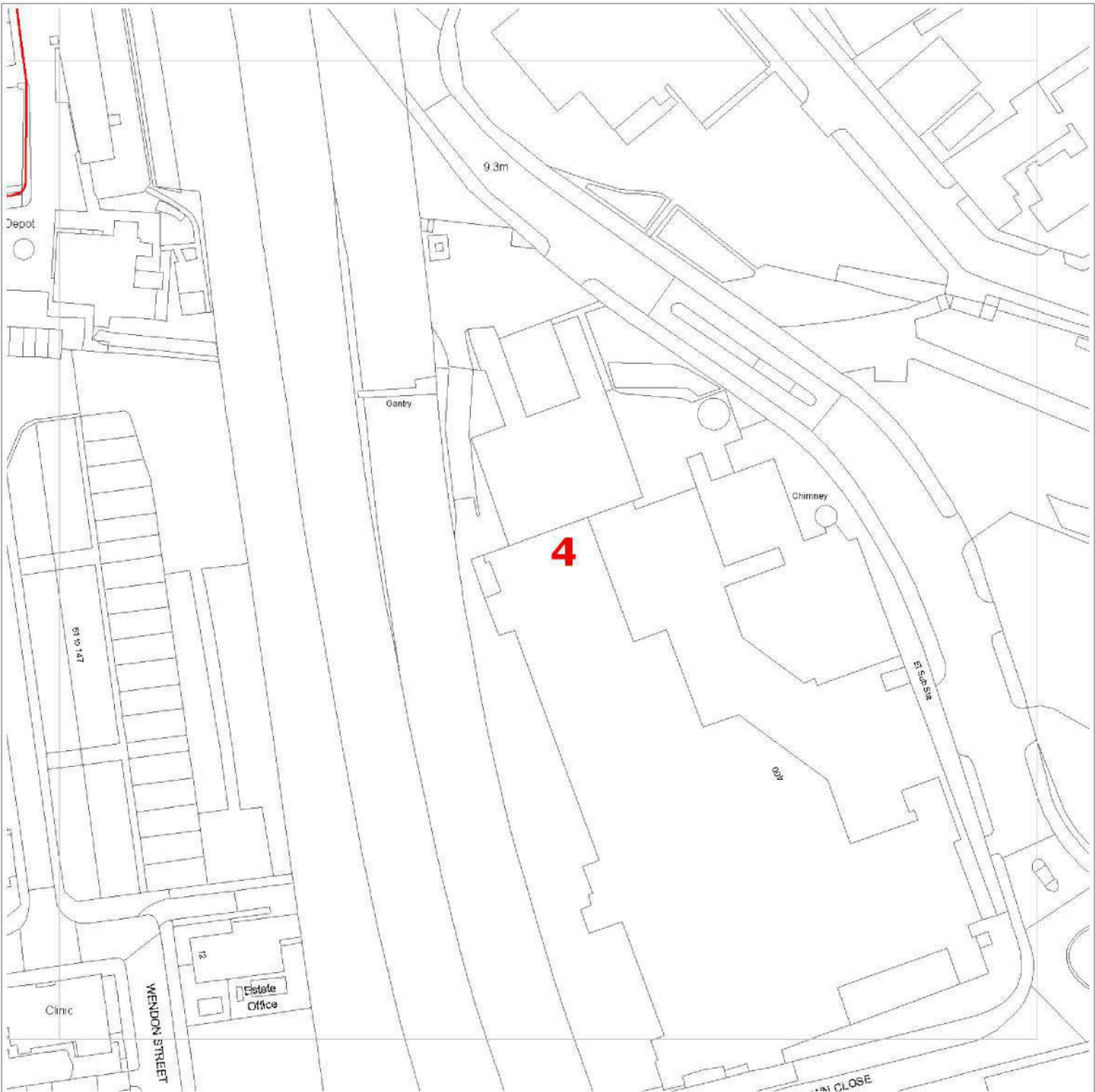





Date Requested: 24/03/2015

Requested by: Stephen Sawyer

Company: Technics Group

Job Reference: 6601423

Your Scheme/Reference: EMS00347

 ZAYO DUCT  
 or  ZAYO CHAMBER  
 Dig Sites: Line  Area   
 Scale on A4 paper: 1:1000



The information on this document is proprietary and shall not be used, copied, reproduced or disclosed in whole or in part without written consent of Zayo Group UK Ltd. Approximate location only is shown. To determine exact location a trial hole must be dug with a Zayo Group UK Ltd Supervisor present. Zayo Group UK Ltd and JSM Construction Ltd accept no liability for errors or omissions.



Protecting Lives, Cables & Pipes

Warning: PDF designed for colour print only with no page scaling. This Information is given as a guide only and its accuracy cannot be guaranteed





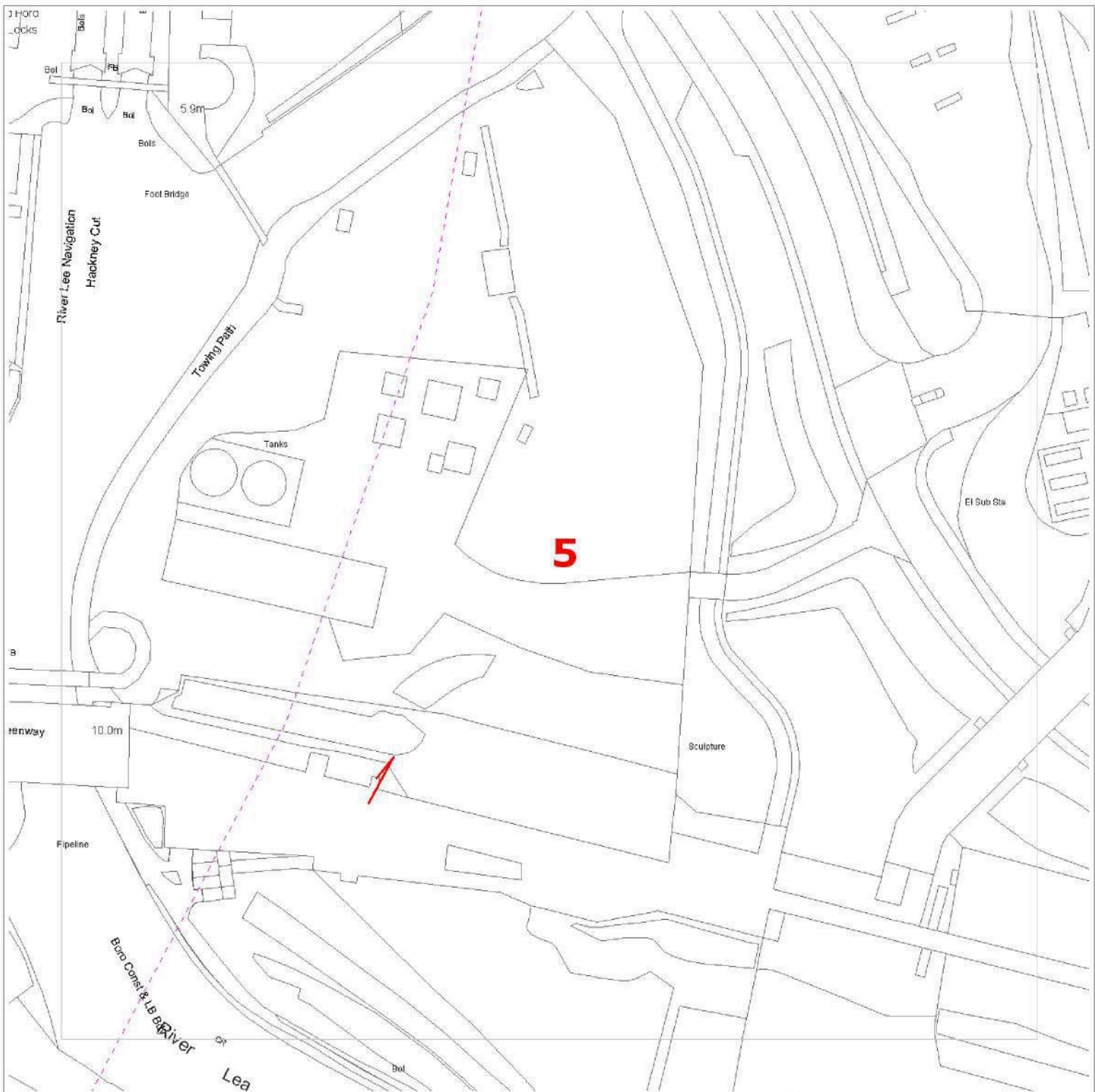

In Emergency Only and if Zayo Plant or Cables damaged call: 0800 169 1646

CROWN COPYRIGHT © All Rights Reserved. Ordnance Survey Licence number: 100040487



Date Requested: 24/03/2015  
 Requested by: Stephen Sawyer  
 Company: Technics Group  
 Job Reference: 6601423  
 Your Scheme/Reference: EMS00347

 ZAYO DUCT  
 or  ZAYO CHAMBER  
 Dig Sites: Line  Area   
 Scale on A4 paper: 1:1000



The information on this document is proprietary and shall not be used, copied, reproduced or disclosed in whole or in part without written consent of Zayo Group UK Ltd. Approximate location only is shown. To determine exact location a trial hole must be dug with a Zayo Group UK Ltd Supervisor present. Zayo Group UK Ltd and JSM Construction Ltd accept no liability for errors or omissions.



Warning: PDF designed for colour print only with no page scaling. This Information is given as a guide only and its accuracy cannot be guaranteed



Protecting Lives, Cables & Pipes

In Emergency Only and if Zayo Plant or Cables damaged call: 0800 169 1646

CROWN COPYRIGHT © All Rights Reserved. Ordnance Survey Licence number: 100040487

## GUIDE TO CONTRACTORS UNDERTAKING EXCAVATIONS IN THE VICINITY OF ZAYO PLANT

1. Prior to commencing any work or moving heavy plant or equipment over any portion of the site, the Contractor shall confirm details of the location of the Zayo apparatus by contacting and requesting utility drawings from LinesearchbeforeUdig

All Enquirers should register free of charge for the Zayo plant enquiry service at

Or follow the direct link to register at

If you have any queries or wish to speak to a member of the JSM Plant Protection Team please call

**The accuracy of information on the plans cannot be guaranteed and no liability can be accepted for errors or omissions.**

2. Where the utility drawings show that the works or the movement of plant or equipment may endanger the Zayo Apparatus the Contractor must mark out the location of the Zayo Apparatus and ensure the apparatus is adequately protected from damage.
3. The contractor should note that damage to Zayo's Fibre-optic network is extremely disruptive and costly to reinstate. The Contractor shall make every effort to avoid the disturbance of Zayo's apparatus for the completion of the work.
4. When excavating, moving or backfilling around Zayo's apparatus The Contractor should note that the normal depth of cover for Zayo ducts are as follows:
  - Carriageway 600mm
  - Footway 350mm
  - Verge 350mm
5. With regard to excavation in the vicinity of Zayo's apparatus the Contractor should be aware of the possibility of reduced cover and the possibility of encountering Zayo apparatus at depths of cover less than that given above.
6. All excavation adjacent to Zayo apparatus is to be carried out by hand until the exact extent and/or location of the Zayo apparatus is known. Use spades and shovels in preference to other tools.

7. Do NOT use Mechanical borers and/or excavators within 0.5m of Zayo Apparatus.
8. To prevent any movement of Zayo apparatus during excavations, complete shuttering shall be used if:
  - The excavation is deeper than the depth of cover of the adjacent Zayo apparatus.
  - The excavation is within 1.0m of Zayo apparatus in stable ground.
  - The excavation is within 5.0m of Zayo apparatus in unstable ground.
9. If for the completion of the works the Contractor intends using any of the following:
  - Pile driving equipment within 10.0m of Company Apparatus.
  - Explosives within 20.0m of Company Apparatus.

Then the Contractor shall advise the Zayo Plant Protection Centre giving a minimum 10 working days written notice.

10. All Zayo manhole, joint box and /or other access points and chambers within the site shall be kept clear and unobstructed at all times to allow access by Zayo and /or their Contractor to carryout maintenance on the network. The Contractor should particularly note that footway type jointing chambers are not specified for carriageway loadings and will need to be adequately protected and/or demolished and rebuilt by Zayo where such chambers are likely to be placed at risk, either temporarily or permanently, from the movement of plant and/or equipment on the site.
11. The covers to Zayo chambers and/or apparatus shall only be lifted by means of appropriate manhole keys under the direct supervision of a Zayo Representative. No employee of the Contractor or of any sub-contractor employed by the Contractor shall enter any Zayo chamber and/or apparatus unless under the supervision of a Zayo Representative.
12. In the event of any damage whatsoever to Zayo apparatus, the Contractor shall immediately report the incidence to Zayo by contacting Zayo as follows:

**Damage to Communications Plant is Expensive – Please Take Care**

Please note these basic safety details are explained in detail in the HSE booklet HS(G)47 – Avoiding Danger from Underground Services.

## Utility Reports

---

**From:**  
**Sent:**  
**To:**  
**Subject:**

**This response is made only in respect to electronic communications apparatus forming part of the Vodafone: Fixed electronic communications network formerly being part of the electronic communications networks of Cable & Wireless UK, Energis Communications Limited, Thus Group Holdings Plc and Your Communications Limited.**

Please accept this email as confirmation that Vodafone: Fixed **does not** have apparatus within the vicinity of your proposed works detailed below.

Many thanks.

ATKINS working on behalf of Vodafone



### **PLEASE NOTE:**

**The information given is indicative only. No warranty is made as to its accuracy. This information must not be solely relied upon in the event of excavation or other works carried out in the vicinity of Vodafone plant. No liability of any kind whatsoever is accepted by Vodafone, its servants, or agents, for any error or omission in respect of information contained on this information. The actual position of underground services must be verified and established on site before any mechanical plant is used. Authorities and contractors will be held liable for the full cost of repairs to Vodafone's apparatus and all claims made against them by Third parties as a result of any interference or damage.**

**Diversions may be necessary if the existing line of the highway/railway or its levels are altered, where apparatus is affected. Where apparatus is affected and requires diversion, you must submit draft details of the proposed scheme with a request for a 'C3 Budget Estimate' to These estimates should be provided normally within 20 working days from receipt of your request. Please include proof of this C2 response when requesting a C3 (using the 'forward' option).**



Stephen Sawyer  
Technics Group  
Technics House  
Merrow Business Park  
Guildford  
GU4 7WA

Date	Our Reference	Your Reference
25 March 2015	PEA-15-03-0232	EMS00347

Dear Sir or Madam:

**RE: Growing Concerns Garden Centre 2 Wick Lane Tower Hamlets E3 2NA  
E536905 184116,N0**

Further to your recent enquiry at the location above, the following BSKYB route(s) are affected:  
**Telewest owned network on Wick Lane please contact them directly for plans**

Although the above BSKYB route(s) are affected, Telewest are responsible for the maintenance or diversion of the affected route as BSKYB only lease Fibre or Duct from them. For further information or detailed plans for this area, please contact their Enquiry Team.

You may be able to contact Telewest (now owned by Virgin Media), by email:

Please be aware that this information may no longer be valid and we do not have any further contact details for this company. Please visit their company website for more information.

Yours sincerely

NRSWA Department  
**Network Infrastructure**  
**Sky Network Services**

**Enquirer**

Name	Mr Stephen Sawyer	Phone	01483230080
Company	Technics Group	Mobile	Not Supplied
		Fax	Not Supplied
Address	Technics House Merrow Business Park Guildford Surrey GU4 7WA		
Email	utility.reports@technicsgroup.com		
Notes	Please ensure your contact details are correct and up to date on the system in case the Asset Owners need to contact you. Where Asset Owners charge for plans they have been requested to send you a quote before proceeding.		

**Enquiry Details**

Scheme/Reference	EMS00347		
Enquiry type	Initial Enquiry	Work category	Development Projects
Start date	30/04/2015	Work type	Commercial/industrial
End date	30/04/2015	Site size	1125 metres diameter
Searched location	XY= 536905, 184116 Easting/Northing	Work type buffer*	25 metres
Confirmed location	536865 184067		

\* The WORK TYPE BUFFER is a distance added to your search area based on the Work type you have chosen

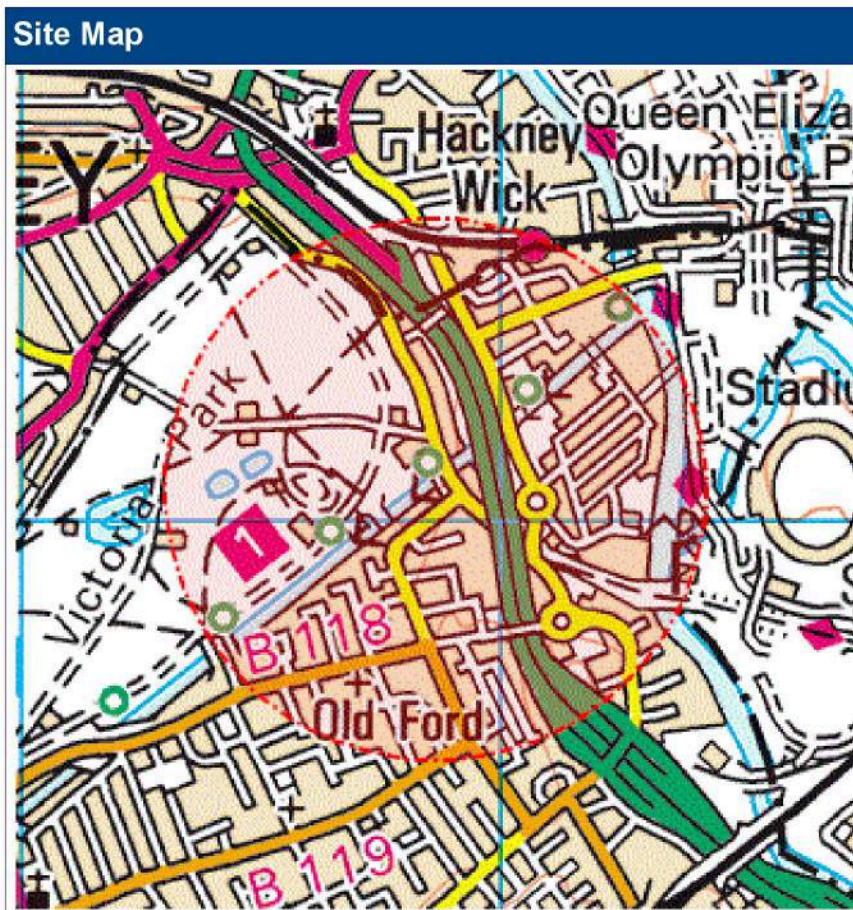



## Asset Owners

Subject always to our standard terms and conditions, this enquiry result is valid for 28 days only from the date of enquiry and is based on the confirmed information you entered. If the location of the work changes then a further enquiry must be made. Should the work not be undertaken within 28 days of the enquiry then a further enquiry must be made.

Where applicable listed below are those registered Asset Owners who have been notified, those to whom you need to send further information and those who have no apparatus within your search area. In addition your response will include other non-registered Asset Owners contact details who have NOT been notified, which may be of interest to you.

Please be aware that the lists below are not exhaustive and that not all Asset Owners are registered with this service. In particular please note that the LineSearchbeforeUdig system only contains information on National Grid's Gas above 2 bar asset and all National Grid Electricity Transmission asset. For National Grid Gas below 2 bar asset information please go to [www.beforeudig.nationalgrid.com](http://www.beforeudig.nationalgrid.com)

**If you are required to email additional info please note that we need the following: Site contact name and number, Location plan, Detailed plan (minimum scale 1:2500), Cross sectional drawings (if available), Work Specification.**

Asset Owners who DO have assets near your proposed work site.

In the Zone of Interest			
Asset Owner	Phone/Email	Emergency Only	Status
ESP Utilities Group			Notified
National Grid Gas (above 2 bar) and National Grid Electricity Transmission			Notified
Zayo Group UK Ltd c/o JSM Group Ltd			Notified

LineSearchbeforeUdig Asset Owners who DO NOT have assets in the immediate vicinity of your proposed work site.

Not in the Zone of Interest		
AWE Pipeline	Gamma	Perenco UK Limited (Purbeck Southampton Pipeline)
BOC Limited (A Member of the Linde Group)	Government Pipelines & Storage System	Phillips 66
BP Midstream Pipelines	Humbly Grove Energy	Premier Transmission Ltd (SNIP)
BPA	HV Cables	RWEnpower (Little Barford and South Haven)
Centrica Energy	IGas Energy	SABIC UK Petrochemicals
Centrica Storage Ltd	Ineos Enterprises Limited	Scottish Power Generation
ConocoPhillips (UK) Ltd	INEOS Manufacturing (Scotland and TSEP)	Seabank Power Ltd
Coryton Energy Co Ltd (Gas Pipeline)	Lark Energy	Shell Pipelines
CSP Fibre c/o Centara	Lightsource SPV Limited	Spiecapag UK Limited (Carrington)
EirGrid	Mainline Pipelines Limited	Total (Finaline, Colnbrook & Colwick Pipelines)
Electricity North West Limited	Manchester Jetline Limited	Transmission Capital
E-on UK Plc (Gas Pipelines Only)	Marchwood Power Ltd (Gas Pipeline)	Vattenfall
ESSAR	Northumbrian Water Group	Western Power Distribution
Esso Petroleum Company Limited	NPower CHP Pipelines	Wingas Storage UK Ltd
FibreSpeed Limited	Oikos Storage Limited	

Date 13/03/2015  
Our Ref LPENQ0000067284

Dear Sir/Madam,

**Teliasonera Line Plant Enquiry**

Thank you for your correspondence enclosing details of your proposals as per your reference below:

**EMS00347 Site at Growing Concerns Garden Centre, Wick Lane**

We can confirm that our client's apparatus, Teliasonera, may be affected by your proposals as indicated on the attached plan. The plan provided is intended for general guidance only and should not be relied upon for excavation and construction purposes. No guarantee is given regarding the accuracy of the information provided.

For all C3 and C4 requests please respond to our Plant Enquiries e-mail

Yours faithfully

Telent CCO

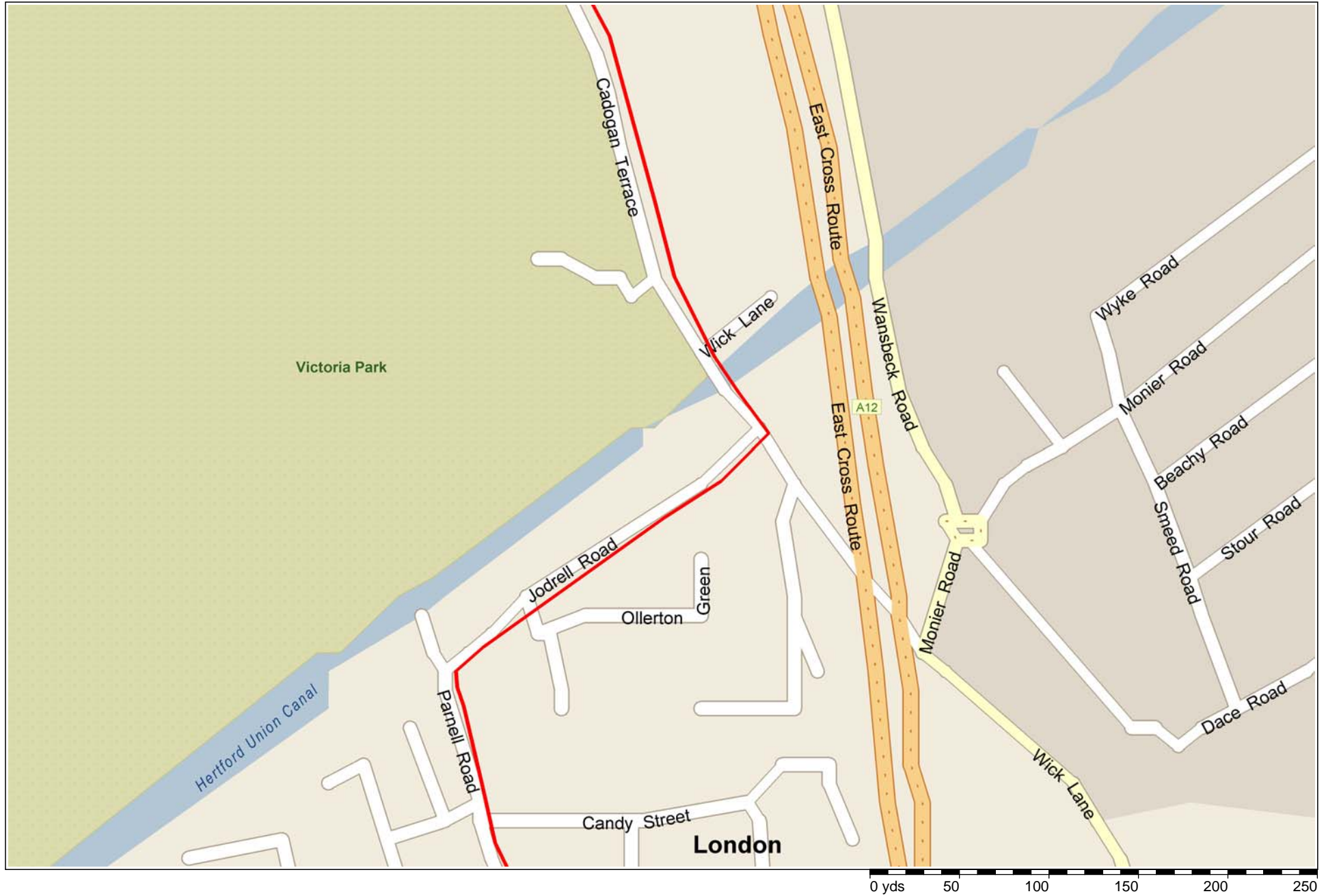



CIVILS AND CABLING INSTALLATION SPECIALIST

17 March 2015

Dear Sir or Madam,

**Your Ref: EMS00347 Growing Concerns Garden Centre, 2, Wick Lane, E3 2NA**  
**Our Ref: E03-15-2940**

With reference to your enquiry regarding the above noted location, I can confirm that LEVEL 3, GLOBAL CROSSING (UK) LTD, GLOBAL CROSSING PEC FIBERNET UK LTD and FIBRESPAN LTD networks **DO NOT** have any apparatus within the immediate proximity of your proposed works.

Instalcom responds to plant enquiries for LEVEL 3, GLOBAL CROSSING (UK) LTD, GLOBAL CROSSING PEC and FIBERNET UK LTD simultaneously and therefore you only need send one copy of a plant enquiry to cover all of these companies. If you would like to query the location further, please email us accordingly and we can arrange an in depth survey, which will be charged at a cost. As we are moving towards a fully electronic database we urge our customers to request plant enquiries by email which will result in a higher level of service, please forward future plant enquiries to

If you require any further information, please do not hesitate to contact me.



Certificate Number 7604  
ISO 9001  
ISO 14001  
OHSAS 18001

DIRECTORS: T.G. & T.J. O'Connor, J.T. McVeigh, D.J. Dix, P.M. Alderton.  
INSTALCOM LIMITED REGISTERED IN ENGLAND No. 3421543



Part of OCU Group

**This response does not include Vtesse plant, please continue to use Vtesse details for their enquiries**

To whom it may concern

Thank you for your enquiry regarding the above proposals at the above location

*We would advise that we are unaware of any Interoute plant or services in this Location as indicated in your enquiry.*

*We bring to your attention the fact that whilst we try to ensure the information we provide is accurate, the information is provided Without Prejudice and Interoute and its Agents accept no liability for claims arising from any inaccuracy, omissions or errors contained in this response.*

**All responses are only valid for 28 days**

Yours faithfully

**PLANCAST Plant Enquiry Department**

Save Paper - Do you really need to print this email? This email and any attachments are or may be confidential and legally privileged and are sent solely for the attention of the addressee(s). If you have received this email in error, please delete it from your system: it's use, disclosure or copying is unauthorised. Statements and opinions expressed in this email may not represent those of PLANCAST. Any representations or commitments in this email are subject to contract.

Registered in England and Wales with number 4455025 VAT No. 8567 195 80

**From:** utility.reports@emapsite.com [mailto:utility.reports@emapsite.com]

**Sent:** 11 March 2015 10:26

**To:** Interoute Enquiries

**Subject:** Plant Location Request EMS00347 Site at GROWING CONCERNS GARDEN CENTRE, 2, WICK LANE, N/A, N/A, E3 2NA

**RE: GROWING CONCERNS GARDEN CENTRE, 2, WICK LANE, N/A, N/A, E3 2NA**

**Location: OSGB: 536905.000,184116.200**

**Our Reference: GRS00347**

Our Company is currently undertaking a utility survey of the site indicated by the co-ordinates detailed above and the attached plan/map.

**NON AFFECTED PLANT ENQUIRY  
SEARCH RETURN NOTIFICATION**

**Kingston Planner:** JS  
**Our Search Ref:** 177025  
**Your Ref:** EMS00347  
**Undertaker Name:** Technics Group  
**Location:** GROWING CONCERNS GARDEN CENTRE, 2, WICK LANE, N/A, N/A, E3  
2NA

**With regards to your request for details of existing services in the search area supplied, we can confirm that based on the details provided to us, we have no buried plant or equipment in the identified area.**

**This is valid for 3 months from the date of receipt of this email. If any further information is required, please call or email our group email address -**



*F.A.O. Whom It May Concern*

*Our Ref: MCN/PE/TATA/A1471/14*

Date: 18 March 2015

*Your Ref: EMS00347*

Dear Sir/Madam,

Thank you for your enquiry for the above reference. We can confirm that **TATA Communications** do have live Fibre Optic Cables at, or nearby, the above location and enclose the relevant drawings showing the approximate location of the apparatus. This information is given as a general guide only and its accuracy cannot be guaranteed.

If your proposed works are likely to affect or expose the TATA Communications apparatus in any way please contact our Works Control Department at the above address, to discuss any plant protection / diversionary measures that may be required, as per the Code of Practice = Measures necessary where apparatus is affected by Major Works (Diversionary Works) Code of Practice NRSWA 1991.

We would remind you that to avoid damage to any apparatus you should always identify its exact position on site, by using hand-digging methods only and that mechanical excavators or borers should never be used within **600mm** of any TATA Communications apparatus.

If we can be of any further assistance please do not hesitate to contact us.

Regards,

**Plant Enquiry Team**



1	09/10/01	AS-BUILT DRG
Iss	Date	Details

THIS DRAWING OR ITS CONTENTS MUST NOT BE REPRODUCED FOR ANY PURPOSE WITHOUT WRITTEN PERMISSION. IT IS TO BE USED ONLY FOR THE PURPOSE FOR WHICH IT IS INTENDED.

KEY:	BOX IDENTIFIER	SECTION IDENTIFIER
PULL BOX		
SPLICE BOX		
EXISTING BOX		
	Box No. --00 CW12 / PB	Sec. --00
	C/C --00 --00 = 400.00m	C/C = 400.00m
	Box - Kerb = 2.50m	4W
	Box - Hedge = 3.40m	
	Box - Bridge = 24.50m	

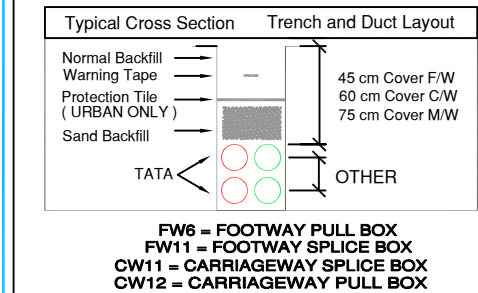

CAUTIONARY NOTE: EVERY EFFORT HAS BEEN MADE TO ACCURATELY POSITION THE LOCATION OF UNDERGROUND DUCTS AND CHAMBERS. THE ACTUAL POSITION OF DUCTS AND CHAMBERS MUST BE VERIFIED AND ESTABLISHED ON SITE, BEFORE ANY MECHANICAL PLANT IS USED.

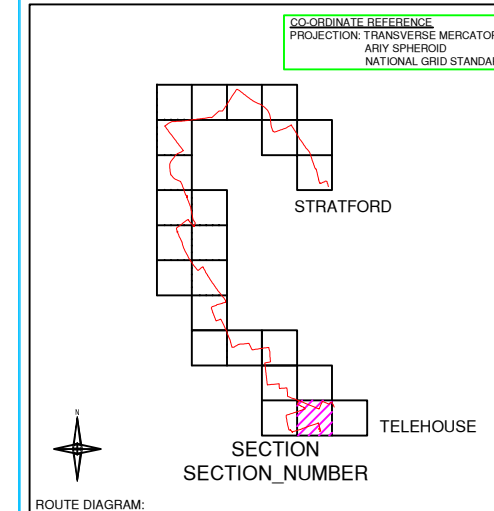

PROJECT: **TGN NETWORK**

CLIENT: **TATA COMMUNICATIONS**

McNicholas  
 Llantrisant Industrial Park, Eistree Road, Eistree, Herts. WD6 3EA  
 Telephone: +44(0)20 8953 4144 Facsimile: +44(0)20 8953 1860  
 Website: <http://www.mcnicholas.co.uk>

THIS PLAN IS REPRODUCED FROM (OR BASED ON) THE ORDNANCE SURVEY MAP, WITH THE SANCTION OF THE H.M STATIONERY OFFICE. CROWN COPYRIGHT RESERVED

O/S Ref:	DRAWN BY	VERSION	SCALE
	GT	AS-BUILT	1:1250
	APPROVED BY		DATE
	JP		18/3/15
DRG. NUMBER			ISSUE
MCN/PE/TATA/A1471/15			1



Dear Sir/Madam

Verizon is a licensed Statutory Undertaker.

We have reviewed your plans and have determined that Verizon (Formally known as MCI WorldCom, MFS) has no apparatus in the areas concerned.

If you have any further queries please do not hesitate to call.

Yours faithfully

Plant Protection Officer (AW)

**From:** utility.reports@emapsite.com [mailto:utility.reports@emapsite.com]

**Sent:** 11 March 2015 10:26

**To:** UK OSP-Team

**Subject:** Plant Location Request EMS00347 Site at GROWING CONCERNS GARDEN CENTRE, 2, WICK LANE, N/A, N/A, E3 2NA

**RE: GROWING CONCERNS GARDEN CENTRE, 2, WICK LANE, N/A, N/A, E3 2NA**

**Location: OSGB: 536905.000,184116.200**

**Our Reference: EMS00347**

Our Company is currently undertaking a utility survey of the site indicated by the co-ordinates detailed above and the attached plan/map.

As part of this survey we are required to indicate positions and descriptions of all main statutory services and wayleaves on site and in the adjoining roads where applicable.

We therefore request that you supply us with relevant plan information at your earliest convenience.

Thanking you in advance of your co-operation.

Yours faithfully

Katarina Malikova  
Utility Report Administrator

**For and on behalf of Technics Group**

Please visit our new website [www.technicsgroup.com](http://www.technicsgroup.com)

T: 01483 230 080

E: [utility.reports@technicsgroup.com](mailto:utility.reports@technicsgroup.com)

Technics Group is the trading name of Sitechnics Limited & Subtechnics Limited  
Subtechnics Limited Registered in England No. 3668620 Sitechnics Limited Registered in England No. 3236243



Technics Group  
Technics House,  
Merrow Business Park,  
Guildford,  
GU4 7WA

Plant Enquiry Ref: VM.114552  
Letter Date 16.03.15  
Your Ref: EMS00347  
Date: 24.03.15

Dear Sir/Madam,

Enquiry Location

GROWING CONCERNS GARDEN CENTRE, 2, WICK LANE, E3 2NA

Thank you for your enquiry regarding work at the above location.

I enclose a copy of our above referenced drawing, marked to show the approximate position of plant owned and operated by Virgin Media.

You will be aware that you have a duty to ensure that no damage results to this equipment as a result of your proposed works. Please note that this apparatus may contain Fibre Optic, Coaxial and/or 240v Power Cables and as such, special care must be taken when excavating this area.

**Should you require Virgin Media apparatus to be diverted to accommodate your works and require a detailed estimate, please send a cheque to the value of £720.00 (Bus) / £240.00 (Res) Inc VAT to:**

Or Call the Diversionary Team on:

**Should your request be in relation to a new development and you require an estimate to be prepared for Virgin Media to service your proposed development, please submit this request for costs along with site drawings (scale 1:500) to the New Build Team also at the above address.**

Yours faithfully

National Plant Enquiries Team

**Please note: National Plant Enquiries are now able to accept all major cards with the exception of American Express for credit/debit card payments. If you wish to use this facility please contact us at the above telephone number. Please note: National Plant Enquiries Team (Bradford) cover and respond to plant enquiries for all ex ntl:Telewest franchise areas.**

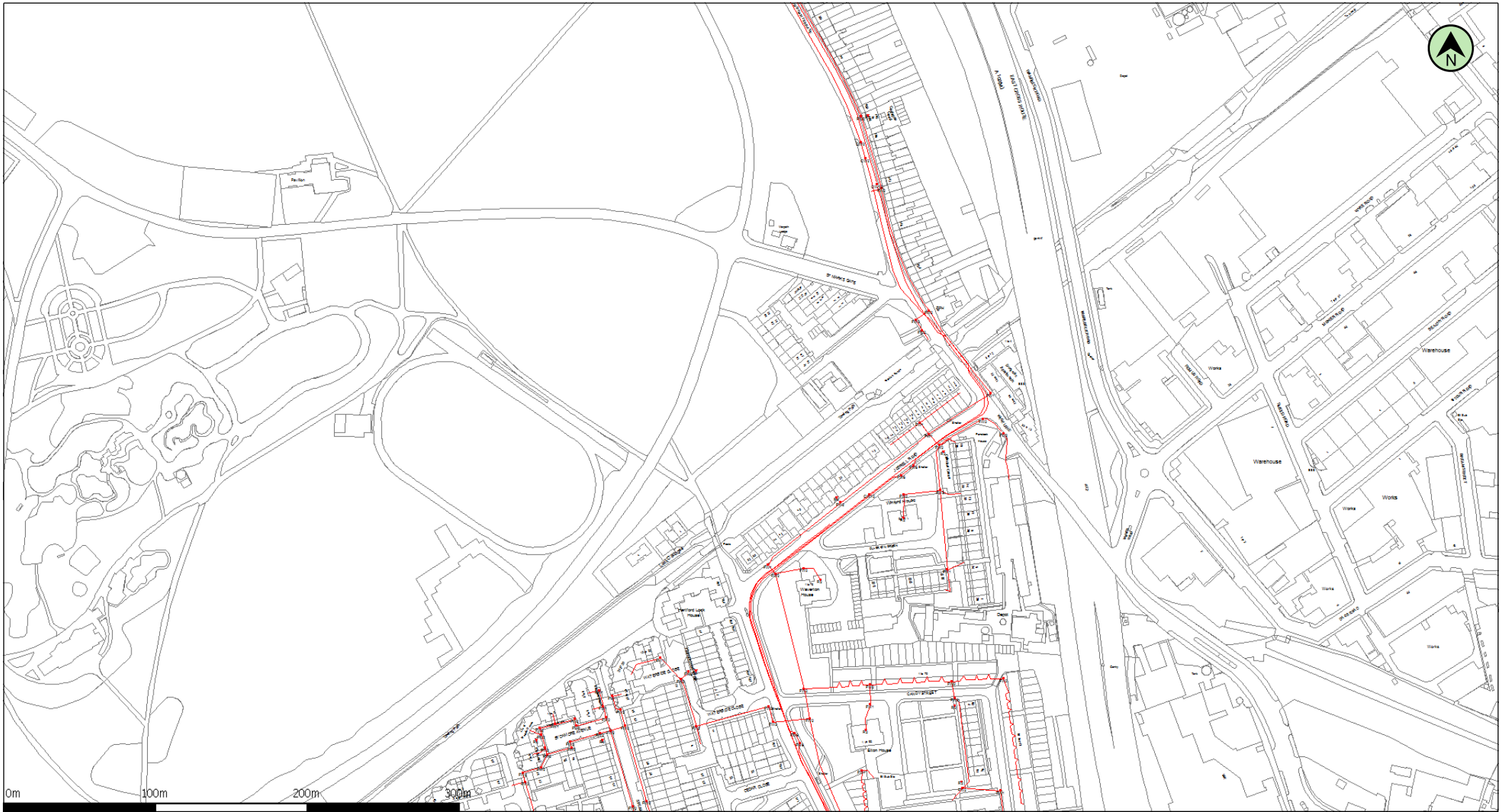

(c) Crown Copyright and database rights 2011 Ordnance Survey 100019209

Date: 24/03/15

Scale: 1:3557

Map Centre: 536787,184077

Data updated: 22/02/15

Telecoms Plan A4

Important Information - please read

The purpose of this plan is to identify Virgin Media apparatus. We have tried to make it as accurate as possible but we cannot warrant its accuracy. In addition, we caution that within Virgin Media apparatus there may be instances where mains voltage power cables have been placed inside green, rather than black ducting. Further details can be found using the 'Affected Postcodes.pdf', which can be downloaded from this website.

Therefore, you must not rely solely on this plan if you are carrying out any excavation or other works in the vicinity of Virgin Media apparatus. The actual position of any underground service must be verified by cable detection equipment, etc. and established on site before any mechanical plant is used. Accordingly, unless it is due to the negligence of Virgin Media, its employees or agents, Virgin Media will not have any liability for any omissions or inaccuracies in the plan or for any loss or damage caused or arising from the use of and/or any reliance on this plan.

This plan is produced by Virgin Media Limited from Ordnance Survey © Crown Copyright 100019209

Duct, Trench



Chamber



Cabinet



# Full service Freeview transmitters

The map below shows the Full Freeview transmitters include the commercial multiplexes and therefore provide all the channels. Those shown with a red icon have fault or engineering information. Please click to see the coverage area, and double click for more information.



## What do the map symbols mean?

 Freeview transmitter.

# Map of all FM, MW and LW transmitters

You can click on a transmitter group symbol to see all the masts in that county or area, or click on a single transmitter to see the coverage area. Due to the large number of radio transmitters, many have been grouped into counties or administrative areas for ease of viewing.

## Showing transmitters in Greater London, England

Transmitters that are in areas that border Greater London, England are shown with a grey background.



## What do the map symbols mean?

 FM/AM radio mast,  FM/AM radio mast (out of area).

# Maps by email Plant Information Reply

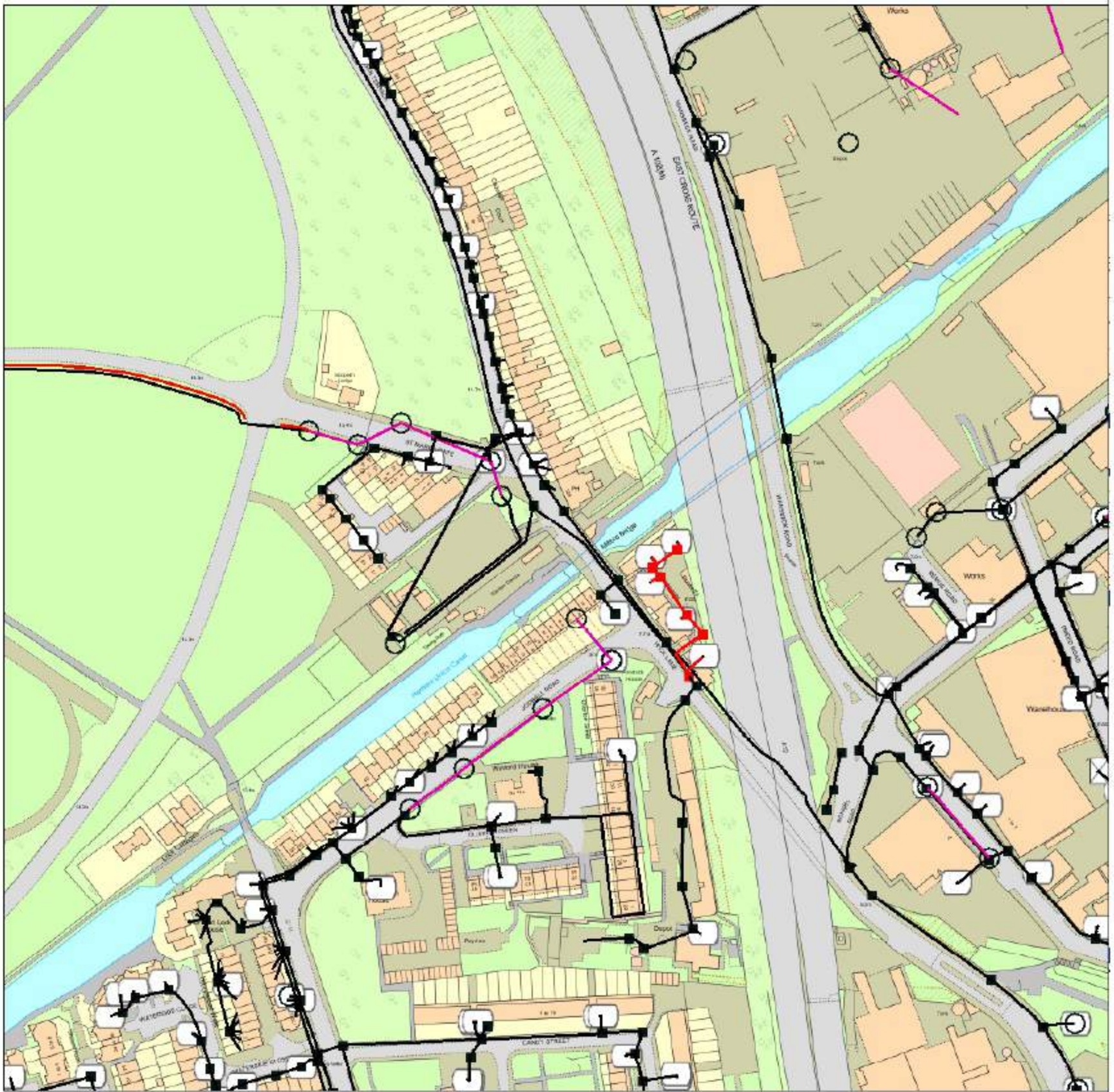

## IMPORTANT WARNING

Information regarding the location of BT apparatus is given for your assistance and is intended for general guidance only. No guarantee is given of its accuracy.

It should not be relied upon in the event of excavations or other works being made near to BT apparatus which may exist at various depths and may deviate from the marked route.

## KEY TO BT SYMBOLS

	UNDERGROUND PLANT		POLE
	OVERHEAD PLANT		CABINET
	JOINT BOX		BURIED JOINT
	DISTRIBUTION POINT		JOINTING POST
	MANHOLE		PROPOSED U/G
	DP BOUNDARY		PROPOSED O/H
	OTHER BT BOUNDARY		PROPOSED BOX

Other proposed plant is shown using dashed lines. BT symbols not listed above may be disregarded. Existing BT plant may not be recorded. Information valid at the time of preparation.

Reproduced from the Ordnance Survey map by BT by permission of Ordnance Survey on behalf of the Controller of Her Majesty's Stationary Office  
(C) Crown Copyright British Telecommunications plc 100028040

**openreach**  
a BT Group business



BT Ref : ISE09314F

Map Reference : (centre) TQ3690584116

Easting/Northing : (centre) 536905,184116

Issued : 24/03/2015 09:32:06

**FOOTNOTE: WARNING IT IS ESSENTIAL THAT YOU CONTACT NATIONAL NETWORK HANDLING CENTRE BY EMAIL BEFORE PROCEEDING WITH ANY WORK IN THE HATCHED AREA**

Oil/Fuel

**Enquirer**

Name	Mr Stephen Sawyer	Phone	01483230080
Company	Technics Group	Mobile	Not Supplied
		Fax	Not Supplied
Address	Technics House Merrow Business Park Guildford Surrey GU4 7WA		
Email	utility.reports@technicsgroup.com		
Notes	Please ensure your contact details are correct and up to date on the system in case the Asset Owners need to contact you. Where Asset Owners charge for plans they have been requested to send you a quote before proceeding.		

**Enquiry Details**

Scheme/Reference	EMS00347		
Enquiry type	Initial Enquiry	Work category	Development Projects
Start date	30/04/2015	Work type	Commercial/industrial
End date	30/04/2015	Site size	1125 metres diameter
Searched location	XY= 536905, 184116 Easting/Northing	Work type buffer*	25 metres
Confirmed location	536865 184067		

\* The WORK TYPE BUFFER is a distance added to your search area based on the Work type you have chosen

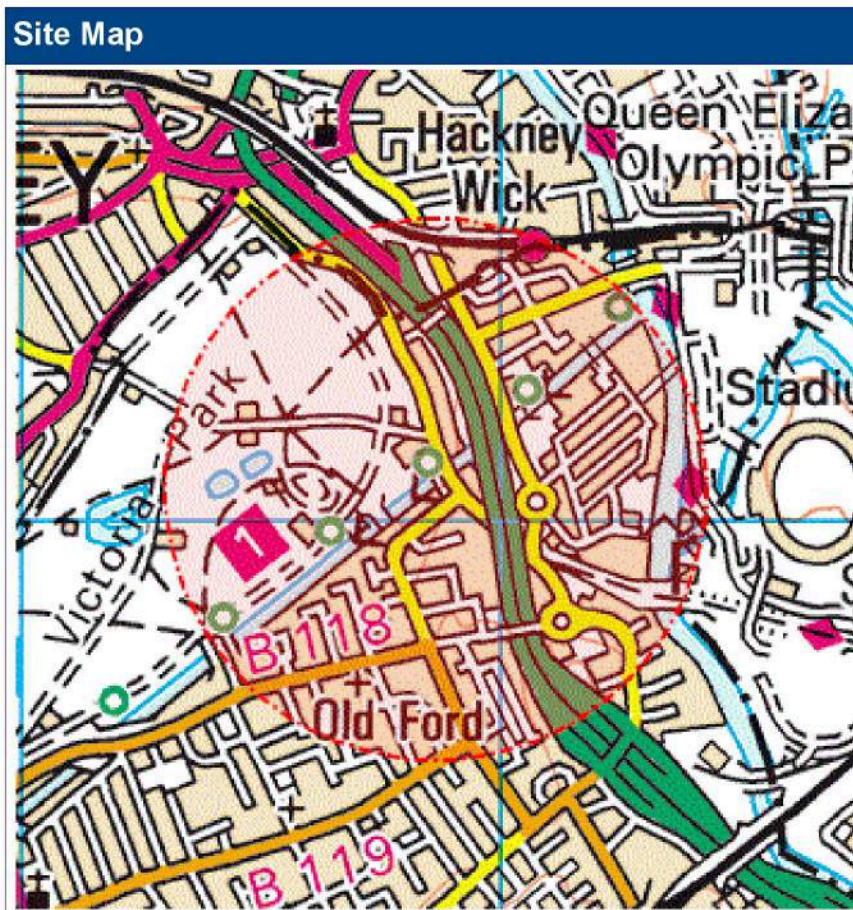



## Asset Owners

Subject always to our standard terms and conditions, this enquiry result is valid for 28 days only from the date of enquiry and is based on the confirmed information you entered. If the location of the work changes then a further enquiry must be made. Should the work not be undertaken within 28 days of the enquiry then a further enquiry must be made.

Where applicable listed below are those registered Asset Owners who have been notified, those to whom you need to send further information and those who have no apparatus within your search area. In addition your response will include other non-registered Asset Owners contact details who have NOT been notified, which may be of interest to you.

Please be aware that the lists below are not exhaustive and that not all Asset Owners are registered with this service. In particular please note that the LineasearchbeforeUdig system only contains information on National Grid's Gas above 2 bar asset and all National Grid Electricity Transmission asset. For National Grid Gas below 2 bar asset information please go to [www.beforeudig.nationalgrid.com](http://www.beforeudig.nationalgrid.com)

**If you are required to email additional info please note that we need the following:  
Site contact name and number, Location plan, Detailed plan (minimum scale 1:2500), Cross sectional drawings (if available), Work Specification.**

Asset Owners who DO have assets near your proposed work site.

In the Zone of Interest			
Asset Owner	Phone/Email	Emergency Only	Status
ESP Utilities Group			Notified
National Grid Gas (above 2 bar) and National Grid Electricity Transmission			Notified
Zayo Group UK Ltd c/o JSM Group Ltd			Notified

LineasearchbeforeUdig Asset Owners who DO NOT have assets in the immediate vicinity of your proposed work site.

Not in the Zone of Interest		
AWE Pipeline	Gamma	Perenco UK Limited (Purbeck Southampton Pipeline)
BOC Limited (A Member of the Linde Group)	Government Pipelines & Storage System	Phillips 66
BP Midstream Pipelines	Humbly Grove Energy	Premier Transmission Ltd (SNIP)
BPA	HV Cables	RWEnpower (Little Barford and South Haven)
Centrica Energy	IGas Energy	SABIC UK Petrochemicals
Centrica Storage Ltd	Ineos Enterprises Limited	Scottish Power Generation
ConocoPhillips (UK) Ltd	INEOS Manufacturing (Scotland and TSEP)	Seabank Power Ltd
Coryton Energy Co Ltd (Gas Pipeline)	Lark Energy	Shell Pipelines
CSP Fibre c/o Centara	Lightsource SPV Limited	Spiecapag UK Limited (Carrington)
EirGrid	Mainline Pipelines Limited	Total (Finaline, Colnbrook & Colwick Pipelines)
Electricity North West Limited	Manchester Jetline Limited	Transmission Capital
E-on UK Plc (Gas Pipelines Only)	Marchwood Power Ltd (Gas Pipeline)	Vattenfall
ESSAR	Northumbrian Water Group	Western Power Distribution
Esso Petroleum Company Limited	NPower CHP Pipelines	Wingas Storage UK Ltd
FibreSpeed Limited	Oikos Storage Limited	

Other

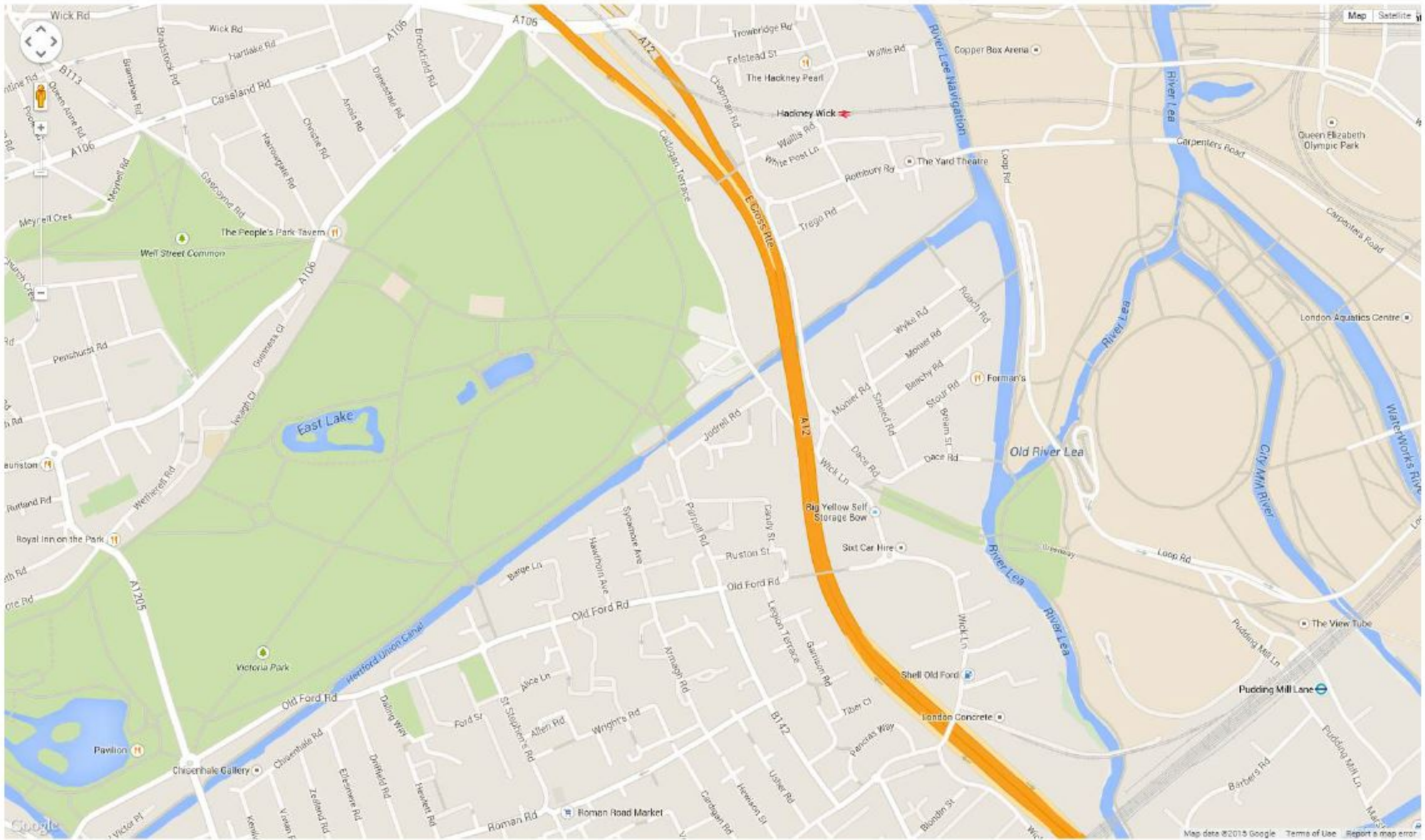

Trafficmaster location



Your ref: EMS00347

Our ref: AD/NRSWA/ENQ/TFL: 35389  
2 April 2015

Dear Sir / Madam

**PLANT ENQUIRY:** Growing Concerns, Garden Centre, 2, Wick Lane, E3 2NA

Thank you for your email dated 11<sup>th</sup> March 2015.

Our records show no traffic control equipment within the site of your anticipated works.

Should you vary the location of the works please inform us so that further checks can be made.

The information relates to traffic control equipment owned by Transport for London, and is believed to be correct.

Yours faithfully

Transport

Date 12 March 2015

Our Ref 20878-NG-5-120315

Your Ref EMS00347

To Katarina Malikova  
Technics Group  
utility.reports@emapsite.com



London Underground Limited

Hello Katarina,

**Garden Centre 2 Wick Lane, London E3 2NA.**

Thank you for your communication of 11<sup>th</sup> March 2015.

I can confirm that London Underground has no assets within 50 metres of your site as shown on the plan you provided.

However your works may affect Transport for London Road Network. Please contact the following for advice if you are carrying out any highway/utility works:

Should you have any further enquiries, please do not hesitate to contact me.



Katarina Malikova  
Technics Group

Your Ref: EMS00347  
Our Ref: 3940

Date 18/03/15

Dear Sir/Madam,

**GROWING CONCERNS GARDEN CENTRE, 2, WICK LANE**

With regards to your enquiry dated 11/03/15, Network Rail does not believe there is any Network Rail owned apparatus or underground services within the area you have defined. As there is always the possibility new works could be planned and undertaken in this area by Network Rail this information is valid as at today's date and is supplied for general guidance only.

Please be aware that this response is based on Network Rail's records (many of which have been inherited from predecessor Organisations) and knowledge and no guarantee can be given regarding accuracy or completeness. CAT scans, safe digging practices (as contained in HSE publications) and other appropriate investigative techniques should always be carried out. There may be other apparatus or underground services owned or operated by Utility Companies and accordingly you should contact individual utilities for information.

If, in connection with your investigations and/or work, you become aware of Network Rail apparatus or underground services within your area of work, please ensure these are notified to me as a matter of urgency so that appropriate measures for avoidance of risk and damage can be put in place

# Water and Sewers



# Asset Location Search



Subtechnics Ltd  
Technics House Merrow Business Pa,

GUILDFORD  
GU4 7WA

**Search address supplied**      Growing Concerns Garden Centre  
2  
Wick Lane  
London  
E3 2NA

**Your reference**                      GRS00347

**Our reference**                        ALS/ALS Standard/2015\_2999202

**Search date**                         20 March 2015



# Asset Location Search



**Search address supplied:** Growing Concerns Garden Centre, 2, Wick Lane, London, E3 2NA

Dear Sir / Madam

**An Asset Location Search is recommended when undertaking a site development.** It is essential to obtain information on the size and location of clean water and sewerage assets to safeguard against expensive damage and allow cost-effective service design.

The following records were searched in compiling this report: - the map of public sewers & the map of waterworks. Thames Water Utilities Ltd (TWUL) holds all of these.

This search provides maps showing the position, size of Thames Water assets close to the proposed development and also manhole cover and invert levels, where available.

Please note that none of the charges made for this report relate to the provision of Ordnance Survey mapping information. The replies contained in this letter are given following inspection of the public service records available to this company. No responsibility can be accepted for any error or omission in the replies.

You should be aware that the information contained on these plans is current only on the day that the plans are issued. The plans should only be used for the duration of the work that is being carried out at the present time. Under no circumstances should this data be copied or transmitted to parties other than those for whom the current work is being carried out.

Thames Water do update these service plans on a regular basis and failure to observe the above conditions could lead to damage arising to new or diverted services at a later date.

# Asset Location Search



## Waste Water Services

**Please provide a copy extract from the public sewer map.**

Enclosed is a map showing the approximate lines of our sewers. Our plans do not show sewer connections from individual properties or any sewers not owned by Thames Water unless specifically annotated otherwise. Records such as "private" pipework are in some cases available from the Building Control Department of the relevant Local Authority.

Where the Local Authority does not hold such plans it might be advisable to consult the property deeds for the site or contact neighbouring landowners.

This report relates only to sewerage apparatus of Thames Water Utilities Ltd, it does not disclose details of cables and or communications equipment that may be running through or around such apparatus.

The sewer level information contained in this response represents all of the level data available in our existing records. Should you require any further Information, please refer to the relevant section within the 'Further Contacts' page found later in this document.

For your guidance:

- The Company is not generally responsible for rivers, watercourses, ponds, culverts or highway drains. If any of these are shown on the copy extract they are shown for information only.
- Any private sewers or lateral drains which are indicated on the extract of the public sewer map as being subject to an agreement under Section 104 of the Water Industry Act 1991 are not an 'as constructed' record. It is recommended these details be checked with the developer.

## Clean Water Services

**Please provide a copy extract from the public water main map.**

Enclosed is a map showing the approximate positions of our water mains and associated apparatus. Please note that records are not kept of the positions of individual domestic supplies.

For your information, there will be a pressure of at least 10m head at the outside stop valve. If you would like to know the static pressure, please contact our Customer

# Asset Location Search



Centre on            The Customer Centre can also arrange for a full flow and pressure test to be carried out for a fee.

For your guidance:

- Assets other than vested water mains may be shown on the plan, for information only.
- If an extract of the public water main record is enclosed, this will show known public water mains in the vicinity of the property. It should be possible to estimate the likely length and route of any private water supply pipe connecting the property to the public water network.

## **Payment for this Search**

A charge will be added to your suppliers account.

# Asset Location Search



## Further contacts:

### **Waste Water queries**

Should you require verification of the invert levels of public sewers, by site measurement, you will need to approach the relevant Thames Water Area Network Office for permission to lift the appropriate covers. This permission will usually involve you completing a TWOSA form. For further information please contact our Customer Centre on Tel: [0344 242424](tel:0344 242424). Alternatively, a survey can be arranged, for a fee, through our Customer Centre on the above number.

If you have any questions regarding sewer connections, budget estimates, diversions, building over issues or any other questions regarding operational issues please direct them to our service desk. Which can be contacted by writing to: [assetlocation@thameswater.co.uk](mailto:assetlocation@thameswater.co.uk)

### **Clean Water queries**

Should you require any advice concerning clean water operational issues or clean water connections, please contact: [0344 242424](tel:0344 242424)

Asset Location Search Sewer Map - ALS/ALS Standard/2015\_2999202

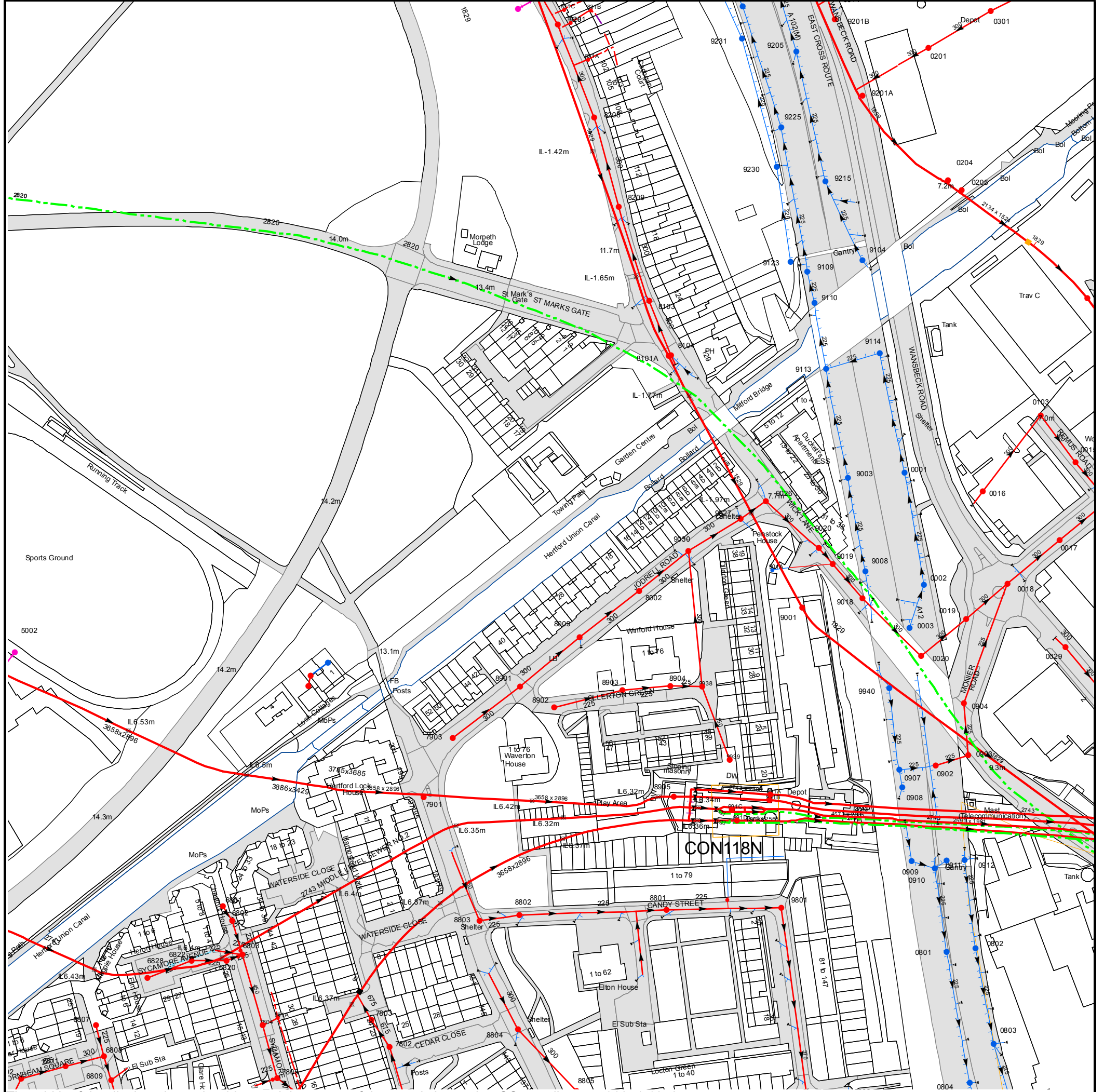

The width of the displayed area is 500 m and the centre of the map is located at OS coordinates 536841,184055

The position of the apparatus shown on this plan is given without obligation and warranty, and the accuracy cannot be guaranteed. Service pipes are not shown but their presence should be anticipated. No liability of any kind whatsoever is accepted by Thames Water for any error or omission. The actual position of mains and services must be verified and established on site before any works are undertaken.

Based on the Ordnance Survey Map with the Sanction of the controller of H.M. Stationery Office, License no. 100019345 Crown Copyright Reserved.

NB. Levels quoted in metres Ordnance Newlyn Datum. The value -9999.00 indicates that no survey information is available

Manhole Reference	Manhole Cover Level	Manhole Invert Level
0029	n/a	n/a
0205	7.62	2.01
0204	n/a	n/a
0301	n/a	n/a
8103	n/a	n/a
8101A	11.02	-1.75
8104	n/a	n/a
9123	n/a	n/a
9109	n/a	n/a
9110	n/a	n/a
9113	n/a	n/a
9003	n/a	n/a
9104	n/a	n/a
9114	n/a	n/a
0001	n/a	n/a
0016	n/a	n/a
0103	n/a	n/a
0015	n/a	n/a
0101B	7.62	1.72
8209	n/a	n/a
9215	n/a	n/a
9230	n/a	n/a
9225	n/a	n/a
8208	n/a	n/a
9201A	6.49	n/a
821A	n/a	n/a
9205	n/a	n/a
0201	n/a	n/a
9231	n/a	n/a
8201	n/a	n/a
821B	n/a	n/a
9201B	n/a	n/a
831B	n/a	n/a
831C	n/a	n/a
8301	11.74	n/a
9340	n/a	n/a
0902	n/a	n/a
9939	n/a	n/a
0903	n/a	n/a
8902	n/a	n/a
0904	n/a	n/a
8903	n/a	n/a
9940	n/a	n/a
9938	n/a	n/a
8901	n/a	n/a
8904	n/a	n/a
0020	n/a	n/a
8003	n/a	n/a
0003	n/a	n/a
0019	n/a	n/a
9001	7.82	-2.1
9018	n/a	n/a
8002	n/a	n/a
0002	n/a	n/a
0018	n/a	n/a
9008	n/a	n/a
901A	n/a	n/a
9019	n/a	n/a
9030	n/a	n/a
9020	n/a	n/a
0017	n/a	n/a
9027	n/a	n/a
9026	n/a	n/a
6809	n/a	n/a
5802	n/a	n/a
7805	n/a	n/a
6811	n/a	n/a
6808	n/a	n/a
7802	n/a	n/a
7804	n/a	n/a
6807	n/a	n/a
7803	n/a	n/a
781A	n/a	n/a
6823	n/a	n/a
6828	n/a	n/a
6822	n/a	n/a
6820	n/a	n/a
6803	n/a	n/a
6802	n/a	n/a
8803	n/a	n/a
6801	n/a	n/a
7901	11.79	n/a
7903	n/a	n/a
79AG	n/a	n/a
79AF	n/a	n/a
70AB	n/a	n/a
5002	14.26	n/a
8804	n/a	n/a
8802	n/a	n/a
8801	n/a	n/a
8905	n/a	n/a

Manhole Reference	Manhole Cover Level	Manhole Invert Level
981A	n/a	n/a
991C	n/a	n/a
991D	n/a	n/a
991B	n/a	n/a
991A	n/a	n/a
9801	n/a	n/a
0907	n/a	n/a
0908	n/a	n/a
0909	n/a	n/a
0910	n/a	n/a
0911	n/a	n/a
0801	n/a	n/a
0912	n/a	n/a
0804	n/a	n/a
0802	n/a	n/a
0803	n/a	n/a



















The position of the apparatus shown on this plan is given without obligation and warranty, and the accuracy cannot be guaranteed. Service pipes are not shown but their presence should be anticipated. No liability of any kind whatsoever is accepted by Thames Water for any error or omission. The actual position of mains and services must be verified and established on site before any works are undertaken.









# ALS Sewer Map Key

## Public Sewer Types (Operated & Maintained by Thames Water)

-  **Foul:** A sewer designed to convey waste water from domestic and industrial sources to a treatment works.
-  **Surface Water:** A sewer designed to convey surface water (e.g. rain water from roofs, yards and car parks) to rivers or watercourses.
-  **Combined:** A sewer designed to convey both waste water and surface water from domestic and industrial sources to a treatment works.
-  Trunk Surface Water
-  Trunk Foul
-  Storm Relief
-  Trunk Combined
-  Vent Pipe
-  Bio-solids (Sludge)
-  Proposed Thames Surface Water Sewer
-  Proposed Thames Water Foul Sewer
-  Gallery
-  Foul Rising Main
-  Surface Water Rising Main
-  Combined Rising Main
-  Sludge Rising Main
-  Proposed Thames Water Rising Main
-  Vacuum





## Sewer Fittings

A feature in a sewer that does not affect the flow in the pipe. Example: a vent is a fitting as the function of a vent is to release excess gas.

-  Air Valve
-  Dam Chase
-  Fitting
-  Meter
-  Vent Column



## Operational Controls

A feature in a sewer that changes or diverts the flow in the sewer. Example: A hydrobrake limits the flow passing downstream.

-  Control Valve
-  Drop Pipe
-  Ancillary
-  Weir





## End Items

End symbols appear at the start or end of a sewer pipe. Examples: an Undefined End at the start of a sewer indicates that Thames Water has no knowledge of the position of the sewer upstream of that symbol, Outfall on a surface water sewer indicates that the pipe discharges into a stream or river.

-  Outfall
-  Undefined End
-  Inlet





## Other Symbols

Symbols used on maps which do not fall under other general categories







-  /  Public/Private Pumping Station
-  Change of characteristic indicator (C.O.C.I.)
-  Invert Level
-  Summit

## Areas

Lines denoting areas of underground surveys, etc.

-  Agreement
-  Operational Site
-  Chamber
-  Tunnel
-  Conduit Bridge

## Other Sewer Types (Not Operated or Maintained by Thames Water)

-  Foul Sewer
-  Surface Water Sewer
-  Combined Sewer
-  Gully
-  Culverted Watercourse
-  Proposed
-  Abandoned Sewer

### Notes:

- 1) All levels associated with the plans are to Ordnance Datum Newlyn.
- 2) All measurements on the plans are metric.
- 3) Arrows (on gravity fed sewers) or flecks (on rising mains) indicate direction of flow.
- 4) Most private pipes are not shown on our plans, as in the past, this information has not been recorded.
- 5) 'na' or '0' on a manhole level indicates that data is unavailable.

- 6) The text appearing alongside a sewer line indicates the internal diameter of the pipe in millimetres. Text next to a manhole indicates the manhole reference number and should not be taken as a measurement. If you are unsure about any text or symbology present on the plan, please contact a member of Property Insight on 0845 070 9148.

Asset Location Search Water Map - ALS/ALS Standard/2015\_2999202

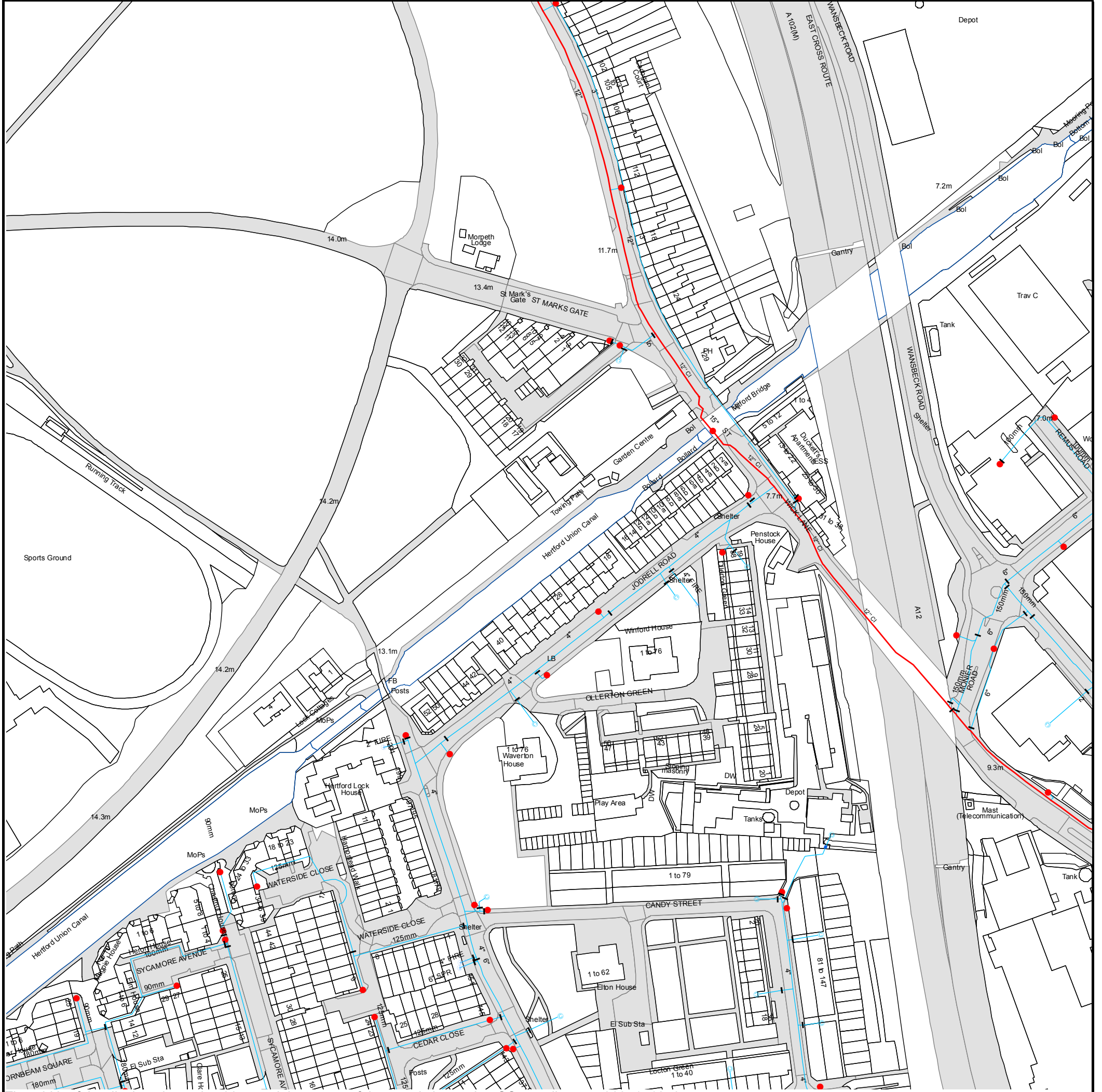

The width of the displayed area is 500 m and the centre of the map is located at OS coordinates 536841, 184055.







The position of the apparatus shown on this plan is given without obligation and warranty, and the accuracy cannot be guaranteed. Service pipes are not shown but their presence should be anticipated. No liability of any kind whatsoever is accepted by Thames Water for any error or omission. The actual position of mains and services must be verified and established on site before any works are undertaken.

Based on the Ordnance Survey Map with the Sanction of the controller of H.M. Stationery Office, License no. 100019345 Crown Copyright Reserved.







# ALS Water Map Key

## Water Pipes (Operated & Maintained by Thames Water)

- 
**4"** **Distribution Main:** The most common pipe shown on water maps. With few exceptions, domestic connections are only made to distribution mains.
- 
**16"** **Trunk Main:** A main carrying water from a source of supply to a treatment plant or reservoir, or from one treatment plant or reservoir to another. Also a main transferring water in bulk to smaller water mains used for supplying individual customers.
- 
**3" SUPPLY** **Supply Main:** A supply main indicates that the water main is used as a supply for a single property or group of properties.
- 
**3" FIRE** **Fire Main:** Where a pipe is used as a fire supply, the word FIRE will be displayed along the pipe.
- 
**3" METERED** **Metered Pipe:** A metered main indicates that the pipe in question supplies water for a single property or group of properties and that quantity of water passing through the pipe is metered even though there may be no meter symbol shown.
- 
**Transmission Tunnel:** A very large diameter water pipe. Most tunnels are buried very deep underground. These pipes are not expected to affect the structural integrity of buildings shown on the map provided.
- 
**Proposed Main:** A main that is still in the planning stages or in the process of being laid. More details of the proposed main and its reference number are generally included near the main.

PIPE DIAMETER	DEPTH BELOW GROUND
Up to 300mm (12")	900mm (3')
300mm - 600mm (12" - 24")	1100mm (3' 8")
600mm and bigger (24" plus)	1200mm (4')

## Valves

-  General Purpose Valve
-  Air Valve
-  Pressure Control Valve
-  Customer Valve

## Hydrants







-  Single Hydrant

## Meters









-  Meter

## End Items

Symbol indicating what happens at the end of a water main.

-  Blank Flange
-  Capped End
-  Emptying Pit
-  Undefined End
-  Manifold
-  Customer Supply
-  Fire Supply



## Operational Sites

-  Booster Station
-  Other
-  Other (Proposed)
-  Pumping Station
-  Service Reservoir
-  Shaft Inspection
-  Treatment Works
-  Unknown
-  Water Tower

## Other Symbols

-  Data Logger

## Other Water Pipes (Not Operated or Maintained by Thames Water)

-  **Other Water Company Main:** Occasionally other water company water pipes may overlap the border of our clean water coverage area. These mains are denoted in purple and in most cases have the owner of the pipe displayed along them.
-  **Private Main:** Indicates that the water main in question is not owned by Thames Water. These mains normally have text associated with them indicating the diameter and owner of the pipe.

## Terms and Conditions

All sales are made in accordance with Thames Water Utilities Limited (TWUL) standard terms and conditions unless previously agreed in writing.

1. All goods remain in the property of Thames Water Utilities Ltd until full payment is received.
2. Provision of service will be in accordance with all legal requirements and published TWUL policies.
3. All invoices are strictly due for payment 14 days from due date of the invoice. Any other terms must be accepted/agreed in writing prior to provision of goods or service, or will be held to be invalid.
4. Thames Water does not accept post-dated cheques-any cheques received will be processed for payment on date of receipt.
5. In case of dispute TWUL's terms and conditions shall apply.
6. Penalty interest may be invoked by TWUL in the event of unjustifiable payment delay. Interest charges will be in line with UK Statute Law 'The Late Payment of Commercial Debts (Interest) Act 1998'.
7. Interest will be charged in line with current Court Interest Charges, if legal action is taken.
8. A charge may be made at the discretion of the company for increased administration costs.

A copy of Thames Water's standard terms and conditions are available from the Commercial Billing Team (cashoperations@thameswater.co.uk).

We publish several Codes of Practice including a guaranteed standards scheme. You can obtain copies of these leaflets by calling us on

If you are unhappy with our service you can speak to your original goods or customer service provider. If you are not satisfied with the response, your complaint will be reviewed by the Customer Services Director. You can write to him at:

If the Goods or Services covered by this invoice falls under the regulation of the 1991 Water Industry Act, and you remain dissatisfied you can refer your complaint to Consumer Council for Water on 0121 345 1000 or write to them at Consumer Council for Water, 1st Floor, Victoria Square House, Victoria Square, Birmingham, B2 4AJ.



## Search Code

### **IMPORTANT CONSUMER PROTECTION INFORMATION**

This search has been produced by Thames Water Property Searches, Clearwater Court, Vastern Road, Reading RG1 8DB, which is registered with the Property Codes Compliance Board (PCCB) as a subscriber to the Search Code. The PCCB independently monitors how registered search firms maintain compliance with the Code.

#### **The Search Code:**

- provides protection for homebuyers, sellers, estate agents, conveyancers and mortgage lenders who rely on the information included in property search reports undertaken by subscribers on residential and commercial property within the United Kingdom
- sets out minimum standards which firms compiling and selling search reports have to meet
- promotes the best practise and quality standards within the industry for the benefit of consumers and property professionals
- enables consumers and property professionals to have confidence in firms which subscribe to the code, their products and services.

By giving you this information, the search firm is confirming that they keep to the principles of the Code. This provides important protection for you.

#### **The Code's core principles**

Firms which subscribe to the Search Code will:

- display the Search Code logo prominently on their search reports
- act with integrity and carry out work with due skill, care and diligence
- at all times maintain adequate and appropriate insurance to protect consumers
- conduct business in an honest, fair and professional manner
- handle complaints speedily and fairly
- ensure that products and services comply with industry registration rules and standards and relevant laws
- monitor their compliance with the Code

#### **Complaints**

If you have a query or complaint about your search, you should raise it directly with the search firm, and if appropriate ask for any complaint to be considered under their formal internal complaints procedure. If you remain dissatisfied with the firm's final response, after your complaint has been formally considered, or if the firm has exceeded the response timescales, you may refer your complaint for consideration under The Property Ombudsman scheme (TPOs). The Ombudsman can award compensation of up to £5,000 to you if he finds that you have suffered actual loss as a result of your search provider failing to keep to the Code.

**Please note that all queries or complaints regarding your search should be directed to your search provider in the first instance, not to TPOs or to the PCCB.**

#### **TPOs Contact Details**

The Property Ombudsman scheme  
Milford House  
43-55 Milford Street  
Salisbury  
Wiltshire SP1 2BP  
Tel: 01722 333306  
Fax: 01722 332296  
Email: [admin@tpos.co.uk](mailto:admin@tpos.co.uk)

You can get more information about the PCCB from [www.propertycodes.org.uk](http://www.propertycodes.org.uk)

**PLEASE ASK YOUR SEARCH PROVIDER IF YOU WOULD LIKE A COPY OF THE SEARCH CODE**

## END USER LICENCE AGREEMENT

### 1 Introduction

By accessing this DATA the End User agrees to abide by the Terms and Conditions of Licence contained herein.

### 2 Definitions

- **LICENSOR** – emapsite.com Limited (Registered Number 3931726: MASDAR House, 1 Reading Road, Eversley, Hants RG27 0RP) who have been licensed to market the Intellectual Property Rights of others under these terms.
- **RESELLER** – Groundsure Limited and/or their own channel partners
- **END USER** – the person, organisation or company who is accessing the DATA, on the basis of these Licence terms, having been accepted as a Licensee by Licensor and paid the Price due to the Reseller in consideration for such Licence, and is identified as the person, organisation or company given on the corresponding invoice for this product from the Reseller.
- **DATA** - means the Products licensed and made available to the End User by the Licensor as a series of data sets which together provide indicative maps showing the underground assets of Utility Providers for England, Wales and Scotland and compiled by Subtechnics Limited.

### 3 Grant of licence

The licence granted to the End User is personal, revocable, non-exclusive and non-transferable, limited to Internal Use (as defined in clause 5 below) as the only Permitted Use by the End User and is for a period as specified in the corresponding order invoice from the Reseller. Save as expressly authorised to vary in accordance with clause 5 below, the End User shall be prohibited from:

- modifying, translating, format-changing, enhancing, reproducing, copying (except where strictly necessary for system back up), redistributing, disseminating, selling, dealing with, licensing, encumbering, reverse engineering, disassembling or decompiling the DATA, or any part of thereof, except to the extent permitted by law;
- using the DATA in any manner for the creation of products or services for Distribution;
- using DATA otherwise than for Internal Use;
- assigning or dealing with in any way its rights under the End User Contract;
- putting, or allowing the DATA (or any Derived Data) to be put on any free, open or public access website; and
- distributing or granting licences of the DATA (in whatever form) or material derived from DATA (including interrogating DATA), save as expressly varied by relevant part of clause 5 below.

### 4 Intellectual Property and Copyright

4.1 The End User must acknowledge and agree that all Intellectual Property Rights in the DATA are the absolute property of the Utility Providers (or where relevant Subtechnics Limited or the licensor). Material which is derived, developed or copied from DATA shall be deemed assigned to the relevant Utility Provider as legal and beneficial owner at creation, except as provided in this paragraph. However, where that material is created by End User under relevant Permitted Use by End User authorised by Licensor in accordance with the Agreement, the Intellectual Property in that material shall belong to the End User.

4.2 Copyright statements must be used with DATA as follows:

© Utility Provider (named as applicable) and Subtechnics Limited

### 5 Permitted use

5.1 PERMITTED USE BY END USER SHALL BE LIMITED TO INTERNAL USE. COMMERCIAL USE SHALL BE PROHIBITED. The meanings of such phrases are set out below.

5.2 Internal Use means the following internal uses by the End User: Without compromising the prohibitions contained in clause 3 above, analysing the DATA against a location or a series of locations to obtain information derived from the DATA such as proximity to underground assets and use of and sharing such information/results of such analysis internally within the End User's legal entity only.

5.3 Commercial Use means use that does not fall under Internal Uses (as above) and involves the provision or any form of Distribution to any third party of the DATA or any material derived from DATA (including Derived Data or Static Data) in connection with, expectation of or anticipation of any direct or indirect commercial benefit or commercial relationship (including a service, broker or agency agreement) and whether or not in return for any consideration (including direct or indirect fee, payment or other benefit), free of charge or for no consideration.

5.4 Derived Data means any material derived from or created using DATA, including where DATA is manipulated, aggregated, integrated, combined, merged, modelled, transformed or processed in or with other data or facilities;

5.5 Static Data means DATA and any data (including Derived Data resulting from Internal Uses presented or included in static format in presentations or reports in hard copy, .pdf or similar format. Static Data does not allow for alteration of the data presented, nor enable any further analysis to be carried out against the data (including against the DATA).

### 6 Confidentiality

6.1 In this clause 6, 'Confidential Information' means all confidential information disclosed (whether in writing, orally

or by another means and whether directly or indirectly) by a Party to the other Party whether before or after the date of this Agreement which might reasonably be considered confidential, including the DATA, information relating to the DATA, and information relating to any of the operations, plans or intentions, clients, contacts, product information, software, data, processes, methods, know-how, trade secrets, market opportunities and business affairs of a Party.

6.2 Each Party shall treat the other Party's Confidential Information as confidential and shall protect it as such. It shall manage it with not less than the same degree of care as it does its own Confidential Information. In any event where Confidential Information is disclosed in any way by one Party ('Disclosing Party') to the other Party ('Receiving Party'), either before or during the Term of this Agreement or after its expiry or termination for any reason, the Receiving Party shall:

not use Confidential Information for a purpose other than the performance of its obligations under this Agreement;  
not disclose Confidential Information to any person except with the prior written consent of the Disclosing Party; and  
make every effort to prevent the use or disclosure of Confidential Information.

6.3 During the term of this Agreement the Receiving Party may disclose Confidential Information solely to the extent that such disclosure is necessary for the purposes of this Agreement, to any of its directors, other officers, employees, End Users, Affiliates, contractors or sub-contractors. Receiving Party shall ensure that persons to whom Confidential Information is disclosed are made aware of and comply with the Receiving Party's obligations of confidentiality as if they were the Receiving Party.

## 7 Information Access

7.1 In so far as the End User is, or is deemed to be, or acts for and on behalf of or on the authority of a Public Authority for the purposes of the Information Access Regimes:

End User acknowledges that the Utility Providers, Subtechnics Limited, Reseller and Licensor consider that DATA is exempted from disclosure because DATA is: proprietary to the Utility Provider and disclosure would harm the interests of the Utility Provider (including its commercial interests);

protected by database rights and other Intellectual Property; confidential and the disclosure of it by the End User would constitute a breach of confidence actionable by the Utility Provider, Subtechnics Limited and/or the Licensor; and confidential commercial or industrial information protected by laws to protect a legitimate economic interest.

7.2 End User shall, in the event it receives a request for information ('Access Request') under the Information Access Regimes pursuant to which the DATA might be disclosed: immediately notify the Reseller of the Access Request and provide the Reseller with full and complete details of the

Access Request and the DATA that may be disclosed, together with any other information the Reseller may request;

consult, as soon as possible within receipt of Access Request, with the Reseller as to whether the DATA constitutes information which is exempt from disclosure or publication pursuant to the Information Access Regimes and/or pursuant to the matters set out above;

notify the Reseller immediately of any final decision as to disclosure of the DATA and no less than 72 hours before any proposed disclosure, as to what if any of the DATA (or any Derived Data) is proposed to be disclosed and co-operate fully and at End User's sole cost with the requirements set out in this paragraph.

7.3 End User shall not disclose the DATA in any publication scheme maintained pursuant to any Information Access Regime without first notifying the Reseller in advance of disclosure in accordance with this paragraph.

7.4 Where the End User is, or is deemed to be, or acts for and on behalf of or on the authority of a Public Authority under the Information Access Regimes and the End User seeks to make disclosure or discloses DATA under the Information Access Regimes without the consent of the Reseller, such disclosure shall entitle the Reseller and/or the Licensor and/or Subtechnics Limited to terminate the End User Contract with immediate effect and without liability on their part.

7.5 The Contracts (Rights of Third Parties) Act 1999 shall apply for the benefit of Subtechnics Limited and the Licensor and the Reseller that Subtechnics Limited and/or the Licensor and/or the Reseller may (but shall have no obligation to) enforce any of the terms in the End User Contract which relate to disclosure under the Information Access Regimes, limitation on liability, use of DATA or infringement of Intellectual Property Rights in the DATA.

## 8 Termination

8.1 The licence must terminate automatically in the event that the End User materially breaches any of the requirement / obligations set out in this End User Licence Agreement. All use of DATA and material derived from DATA shall cease promptly in such event, except as follows:

- Following expiry of the End User Contract, the End User may continue to use limited material created using DATA during the term of its End User Contract. Such material is limited to that which is both properly authorised as relevant Permitted Use by the End User and is in static form, i.e. such that after termination it is not changed, added to, updated, modified in any other way or used in or to create any new, updated, supplemented or modified product, tool, analysis or material.
- Material which is not in static form (including probabilistic modelling and models and output therefrom, which is automatically deemed to be not static) shall not be used after termination of the End User Contract.

- the End User must be prohibited from using DATA (including in Reseller's Product/Service), and from deriving any new, updated, supplemented or modified product, tool or material from DATA, after the date of termination of its End User Contract.

8.2 The invalidity or unenforceability of any part of this Agreement shall not prejudice or affect the validity or enforceability of the remainder of the Agreement, which shall remain in full force and effect. If any provision of this Agreement is found to be invalid, illegal or unenforceable but would cease to be so if some part of the provision were deleted or modified, the provision in question shall apply with such minimum modification as may be necessary to make it valid, legal and enforceable and still give effect to the commercial intention of the Parties in this Agreement.

## 9 Fees

9.1 The End User must acknowledge its obligation to pay licence fees to the Reseller. The total price of the Products shall be the Reseller's written quoted price as varied from time to time. The price is exclusive of any applicable Value Added Tax, which the End User shall be additionally liable to pay to Licensors.

9.2 End User shall pay in full on order or shall pay within 30 days of the date of invoice, if accepted for an account with the Reseller. The time of payment shall be of the essence of the Contract. All payments shall be made in full without deduction in respect of any set-off or counterclaim. If the End User fails to make any payment on the due date then without prejudice to any other right or remedy available to Licensors, Licensors shall be entitled to:

cancel the Contract or suspend any deliveries to the End User;

appropriate any payment made by the End User to the DATA; and

charge the End User interest (both before and after any judgment) on the amount unpaid, at the rate of 4 per cent per annum over the base rate for the time being of Barclays Bank PLC.

Licence to DATA is not deemed to commence until payment has been made of the Price in full to Licensors.

## 10 Liability

10.1 Licensors warrant that the DATA will correspond with its specification at the time of delivery. The above warranty does not extend to any defect resulting from use of the DATA with materials or equipment not supplied by Licensor. The above warranty is given by Licensors subject to the following conditions:

Neither Licensor nor Reseller shall be under any liability in respect of any defect in the DATA arising from any drawing, design or specification supplied by the End User or in respect of any defect arising from failure to follow Licensors' guidance, misuse or alteration of the DATA without Licensors' approval;

Neither Licensor nor Reseller shall be under any liability under the above warranty (or any other warranty, condition or guarantee) if the total price for the DATA has not been paid by the due date for payment; and Except in respect of death or personal injury caused by Licensor or Reseller's negligence, neither Licensor nor Reseller shall be liable to the End User for any consequential loss or damage (whether for loss of profit or otherwise), costs, expenses, or other claim for consequential compensation whatsoever which arises out of or in connection with the supply of the DATA, except as expressly provided in these Conditions.

Except in respect of injury to or death of any person Licensor's and Reseller's aggregate liability for breach of contract, negligence or other default shall not exceed the value of the Contract.

Except as expressed here all warranties, conditions or other terms implied by statute or common law are excluded to the fullest extent permitted by law.

## 11 Governing Law and Jurisdiction

The End User Contract and any matter, dispute or claim arising from or in connection with the End User Contract in so far as it applies to DATA and its use (including non-contractual disputes or claims) shall be governed by and construed in accordance with English law. The End User must submit to the mediation process prescribed in the Agreement and, subject to that, to the exclusive jurisdiction of the English court.



Contents	
1	Cover Page
2	Content & Information
3	Content & Information
4	Terms and Conditions
5	Site Location
6	Results Schedule
7	Results Schedule – Response Table
8	Results Schedule – Response Table
9	Electricity Results
10	UK Power Networks
11	UK Power Networks
12	UK Power Networks
13	UK Power Networks
14	UK Power Networks
15	UK Power Networks
16	UK Power Networks
17	UK Power Networks
18	UK Power Networks
19	UK Power Networks
20	UK Power Networks
21	UK Power Networks
22	UK Power Networks
23	UK Power Networks
24	UK Power Networks
25	UK Power Networks
26	UK Power Networks
27	UK Power Networks
28	UK Power Networks
29	UK Power Networks
30	UK Power Networks
31	UK Power Networks
32	UK Power Networks
33	UK Power Networks
34	UK Power Networks
35	UK Power Networks
36	UK Power Networks
37	UK Power Networks
38	UK Power Networks
39	UK Power Networks
40	UK Power Networks
41	UK Power Networks
42	UK Power Networks
43	UK Power Networks
44	UK Power Networks
45	UK Power Networks
46	UK Power Networks
47	UK Power Networks
48	UK Power Networks

49	UK Power Networks
50	UK Power Networks
51	UK Power Networks
52	UK Power Networks
53	UK Power Networks
54	UK Power Networks
55	UK Power Networks
56	UK Power Networks
57	UK Power Networks
58	National Grid UK
59	National Grid UK
60	National Grid UK
61	National Grid UK
62	National Grid UK
63	National Grid UK
64	National Grid UK
65	National Grid UK
66	National Grid UK
67	National Grid UK
68	National Grid UK
69	National Grid UK
70	National Grid UK
71	National Grid UK
72	National Grid UK
73	National Grid UK
74	National Grid UK
75	National Grid UK
76	National Grid UK
77	National Grid UK
78	National Grid UK
79	National Grid UK
80	National Grid UK
81	National Grid UK
82	National Grid UK
83	National Grid UK
84	National Grid UK
85	National Grid UK
86	National Grid UK
87	National Grid UK
88	National Grid UK
89	National Grid UK
90	Energetics
91	ESP Utilities Group
92	ESP Utilities Group
93	ESP Utilities Group
94	ESP Utilities Group
95	ESP Utilities Group
96	ESP Utilities Group
97	ESP Utilities Group
98	ESP Utilities Group

99	ESP Utilities Group
100	ESP Utilities Group
101	ESP Utilities Group
102	ESP Utilities Group
103	GTC Pipelines
104	GTC Pipelines
105	GTC Pipelines
106	GTC Pipelines
107	GTC Pipelines
108	GTC Pipelines
109	GTC Pipelines
110	GTC Pipelines
111	GTC Pipelines
112	GTC Pipelines
113	Gas Results
114	National Grid UK
115	National Grid UK
116	National Grid UK
117	National Grid UK
118	National Grid UK
119	National Grid UK
120	National Grid UK
121	National Grid UK
122	National Grid UK
123	National Grid UK
124	National Grid UK
125	National Grid UK
126	National Grid UK
127	National Grid UK
128	National Grid UK
129	National Grid UK
130	National Grid UK
131	National Grid UK
132	National Grid UK
133	National Grid UK
134	National Grid UK
135	National Grid UK
136	National Grid UK
137	National Grid UK
138	National Grid UK
139	National Grid UK
140	National Grid UK
141	National Grid UK
142	National Grid UK
143	National Grid UK
144	National Grid UK
145	National Grid UK
146	National Grid UK

147	National Grid UK
148	National Grid UK
149	Energetics
150	ESP Utilities Group
151	ESP Utilities Group
152	ESP Utilities Group
153	ESP Utilities Group
154	ESP Utilities Group
155	ESP Utilities Group
156	ESP Utilities Group
157	ESP Utilities Group
158	ESP Utilities Group
159	ESP Utilities Group
160	ESP Utilities Group
161	ESP Utilities Group
162	GTC Pipelines
163	GTC Pipelines
164	GTC Pipelines
165	GTC Pipelines
166	GTC Pipelines
167	GTC Pipelines
168	GTC Pipelines
169	GTC Pipelines
170	GTC Pipelines
171	GTC Pipelines
172	Telecoms/Cable Results
173	Zayo Europe
174	Zayo Europe
175	Zayo Europe
176	Zayo Europe
177	Zayo Europe
178	Zayo Europe
179	Zayo Europe
180	Zayo Europe
181	Zayo Europe
182	Atkins Global
183	Easynet
184	Gamma Telecom Limited
185	Gamma Telecom Limited
186	Telent
187	Telent
188	Instalcom
189	Interoute
190	KCOM
191	McNicholas
192	McNicholas
193	Verizon
194	Virgin Media

195	Virgin Media
196	Radio and Freeview Transmitters
197	Radio and Freeview Transmitters
198	BT
199	Oil/Fuel Results
200	Linesearch
201	Linesearch
202	Other Results
203	Trafficmaster
204	Transport for London – London Streets
205	Transport Results
206	London Underground
207	Network Rail
208	Water and Sewer Results
209	Thames Water
210	Thames Water
211	Thames Water
212	Thames Water
213	Thames Water
214	Thames Water
215	Thames Water
216	Thames Water
217	Thames Water
218	Thames Water
219	Thames Water
220	Thames Water
221	Thames Water
222	End User Licence Agreement
223	End User Licence Agreement
224	End User Licence Agreement
225	Contents Page
226	Contents Page
227	Contents Page
228	Contents Page
229	Contents Page